

PROGRAMMABLE QUAD OPERATIONAL AMPLIFIERS

The LM346 consists of four independent, high gain, internally compensated, low power programmable amplifiers. Two external resistors (R_{set}) allow the user to program the gain-bandwidth product, slew rate, supply current, input bias current, input offset current and input noise. For example the user can trade-off supply current for bandwidth or optimize noise figure for a given source resistance. In a similar way other amplifier characteristics can be tailored to the application.

Except for the two programming pins at the end of the package the LM346 pin out is the same as the LM324 and LM348.

PROGRAMMING EQUATIONS :

Total supply current = 1.4 mA ($I_{set} = 10 \mu A$)

Gain-bandwidth product = 1 MHz ($I_{set} = 10 \mu A$)

Slew rate = 0.4 V/ μs ($I_{set} = 10 \mu A$)

Input bias current = 50 nA ($I_{set} = 10 \mu A$)

I_{set} = current into pin 8 and pin 9 (see schematic diagram)

$$I_{set} = \frac{V_{CC}^+ - V_{CC}^- - 0.6V}{R_{set}}$$

- Programmable electrical characteristics.
- Battery powered operation.
- Low supply current (350 μA /amplifier).
- Gain-bandwidth product : 1 MHz.
- Large dc voltage gain : 120 dB.
- Low noise voltage : 28 nV/ \sqrt{Hz} .
- Wide power supply range : $\pm 1.5 V$ to $\pm 22 V$.
- Classe AB output stage. No cross-over distortion.
- Overload protection for inputs and outputs.

ORDERING INFORMATION

Hi-Rel versions available - See chapter 14

PART NUMBER	TEMPERATURE RANGE	PACKAGE			
		DP	DG	FP	GC
LM146	-55°C to +125°C		•		•
LM246	-25°C to + 85°C	•	•		
LM346	0°C to + 70°C	•	•	•	

Examples : LM146DG, LM246DP

PROGRAMMABLE QUAD OPERATIONAL AMPLIFIERS

CASES

CB-79

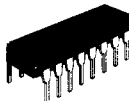

DP SUFFIX
PLASTIC PACKAGE
DG SUFFIX
CERDIP PACKAGE

CB-369



FP SUFFIX
PLASTIC
MICROPACKAGE

CB-705



GC SUFFIX
TRICECOP (LCC)

CB-79 and CB-369

PIN ASSIGNMENTS (Top views)

CB-705

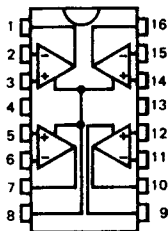

- 1 - Output 1
- 2 - Inverting input 1
- 3 - Non-inverting input 1
- 4 - V_{CC}
- 5 - Non-inverting input 2
- 6 - Inverting input 2
- 7 - Output 2
- 8 - Set
- 9 - Set
- 10 - Output 3
- 11 - Inverting input 3
- 12 - Non-inverting input 3
- 13 - V_{CC}
- 14 - Non-inverting input 4
- 15 - Inverting input 4
- 16 - Output 4



- 1 - NC
- 2 - Output 1
- 3 - Inverting input 1
- 4 - Non-inverting input 1
- 5 - V_{CC}
- 6 - NC
- 7 - Non-inverting input 2
- 8 - Inverting input 2
- 9 - Output 2
- 10 - Set 1, 2, 4
- 11 - NC
- 12 - Set 3
- 13 - Output 3
- 14 - Inverting input 3
- 15 - Non-inverting input 3
- 16 - NC
- 17 - V_{CC}
- 18 - Non-inverting input 4
- 19 - Inverting input 4
- 20 - Output 4

MAXIMUM RATINGS

Rating	Symbol	LM146	LM246	LM346	Unit
Supply voltage	V_{CC}	± 22	± 18	± 18	V
Input voltage (Note 1)	V_I	± 15	± 15	± 15	V
Differential input voltage	V_{ID}	± 30	± 30	± 30	V
Output short-circuit duration (Note 2)		indefinite	indefinite	indefinite	
Power dissipation	P_{tot}	865	500	500	mW
	GC suffix DG suffix	*X0		900	
Operating free-air temperature range	T_{oper}	-55 to +125	-25 to +85	0 to +70	$^{\circ}C$
Storage temperature range	T_{stg}	-65 to +150	-65 to +150	-65 to +150	$^{\circ}C$

Note 1 : For supply voltages less than ± 15 V, the absolute maximum input voltage is equal to the supply voltage.

Note 2 : Any of the amplifier outputs can be shorted to ground indefinitely, however more than one should not be simultaneously shorted as the maximum junction temperature will be exceeded.

SCHEMATIC DIAGRAM (1/4 LM146)

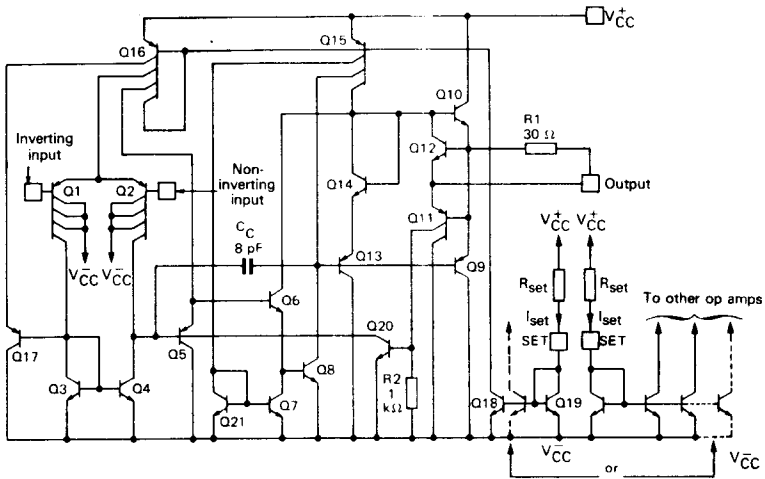

CASE	Inverting inputs	Non-inverting inputs	V_{CC-}	V_{CC+}	Outputs	SET	N.C.
CB-79/CB-369	3, 5, 12, 14	2, 6, 11, 15	13	4	1, 7, 10, 16	8, 9	-
CB-705	3, 8, 14, 19	4, 7, 15, 18	17	5	2, 9, 13, 20	10, 12	*

* CB-705 : Other pins are not connected.

ELECTRICAL CHARACTERISTICS

LM146 : $-55^{\circ}\text{C} \leq T_{\text{amb}} \leq +125^{\circ}\text{C}$, $V_{\text{CC}} = \pm 15 \text{ V}$, $I_{\text{set}} = 10\mu\text{A}$ LM246 : $-0^{\circ}\text{C} \leq T_{\text{amb}} \leq +70^{\circ}\text{C}$, $V_{\text{CC}} = \pm 15 \text{ V}$, $I_{\text{set}} = 10\mu\text{A}$ LM346 : $-25^{\circ}\text{C} \leq T_{\text{amb}} \leq +85^{\circ}\text{C}$, $V_{\text{CC}} = \pm 15 \text{ V}$, $I_{\text{set}} = 10\mu\text{A}$

(Unless otherwise specified)

Characteristic	Symbol	LM146			LM246, LM346			Unit
		Min	Typ	Max	Min	Typ	Max	
Input offset voltage ($R_S \leq 50 \Omega$) $T_{\text{amb}} = +25^{\circ}\text{C}$ $T_{\text{min}} \leq T_{\text{amb}} \leq T_{\text{max}}$	V_{IO}	— —	0.5 0.5	5 6	— —	0.5 0.5	6 7.5	mV
Input offset current $T_{\text{amb}} = +25^{\circ}\text{C}$ $T_{\text{min}} \leq T_{\text{amb}} \leq T_{\text{max}}$	I_{IO}	— —	2 2	20 25	— —	2 2	100 100	nA
Input bias current $T_{\text{amb}} = +25^{\circ}\text{C}$ $T_{\text{min}} \leq T_{\text{amb}} \leq T_{\text{max}}$	I_{IB}	— —	50 50	100 100	— —	50 50	250 250	nA
Large signal voltage gain ($\Delta V_{\text{O}} = \pm 10 \text{ V}$, $R_L = 10 \text{ k}\Omega$) $T_{\text{amb}} = +25^{\circ}\text{C}$ $T_{\text{min}} \leq T_{\text{amb}} \leq T_{\text{max}}$	A_{VD}	100 50	1000 1000	— —	50 25	1000 1000	— —	V/mV
Supply voltage rejection ratio $R_S \leq 10 \text{ k}\Omega$, $T_{\text{amb}} = +25^{\circ}\text{C}$ $R_S \leq 50 \Omega$, $T_{\text{min}} \leq T_{\text{amb}} \leq T_{\text{max}}$	SVR	80 76	100 100	— —	74 74	100 100	— —	dB
Supply current $T_{\text{amb}} = +25^{\circ}\text{C}$ $T_{\text{min}} \leq T_{\text{amb}} \leq T_{\text{max}}$	I_{CC}	— —	1.4 1.5	2 2	— —	1.4 1.5	2.5 2.5	mA
Input voltage range $T_{\text{amb}} = +25^{\circ}\text{C}$ $T_{\text{min}} \leq T_{\text{amb}} \leq T_{\text{max}}$	V_{I}	± 13.5 ± 13.5	± 14 ± 14	— —	± 13.5 ± 13.5	± 14 ± 14	— —	V
Common-mode rejection ratio $R_S \leq 10 \text{ k}\Omega$, $T_{\text{amb}} = +25^{\circ}\text{C}$ $R_S \leq 50 \Omega$, $T_{\text{min}} \leq T_{\text{amb}} \leq T_{\text{max}}$	CMR	80 70	100 100	— —	70 70	100 100	— —	dB
Output short-circuit current ($T_{\text{amb}} = +25^{\circ}\text{C}$)	I_{OS}	5	20	30	5	20	30	mA
Output voltage swing ($R_L \geq 10 \text{ k}\Omega$) $T_{\text{amb}} = +25^{\circ}\text{C}$ $T_{\text{min}} \leq T_{\text{amb}} \leq T_{\text{max}}$	V_{OPP}	± 12 ± 12	± 14 ± 14	— —	± 12 ± 12	± 14 ± 14	— —	V
Gain-bandwidth product ($T_{\text{amb}} = +25^{\circ}\text{C}$)	GBP	0.8	1.2	—	0.5	1.2	—	MHz
Slew rate ($T_{\text{amb}} = +25^{\circ}\text{C}$)	S_{VO}	—	0.4	—	—	0.4	—	V/ μs
Equivalent input noise voltage ($f = 1 \text{ kHz}$, $T_{\text{amb}} = +25^{\circ}\text{C}$)	V_{n}	—	28	—	—	28	—	nV/ $\sqrt{\text{Hz}}$
Input resistance ($T_{\text{amb}} = +25^{\circ}\text{C}$)	R_{I}	—	1	—	—	1	—	M Ω
Input capacitance ($T_{\text{amb}} = +25^{\circ}\text{C}$)	C_{I}	—	2	—	—	2	—	pF
Channel separation ($\Delta V_{\text{O}} = 0\text{V}$ to $+12 \text{ V}$, $R_L \geq 10 \text{ k}\Omega$, $T_{\text{amb}} = +25^{\circ}\text{C}$)	$V_{\text{O1}}/V_{\text{O2}}$	—	120	—	—	120	—	dB
Phase margin ($C_L = 100 \text{ pF}$, $T_{\text{amb}} = +25^{\circ}\text{C}$)	φ_{M}	—	60	—	—	60	—	Degree

INPUT BIAS CURRENT vs I_{set}

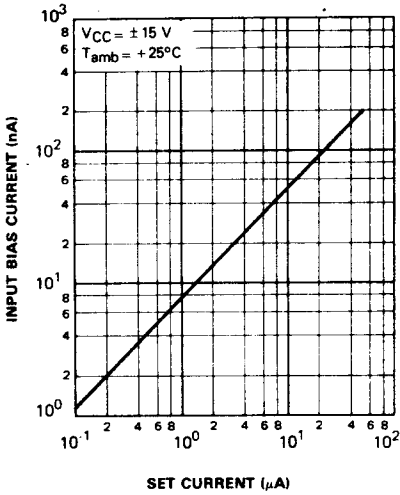

SUPPLY CURRENT vs I_{set}

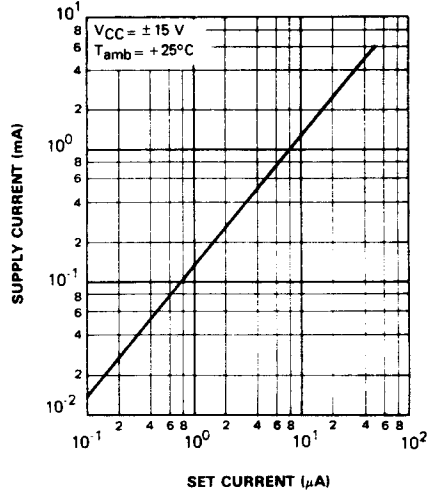

OPEN LOOP VOLTAGE GAIN vs I_{set}

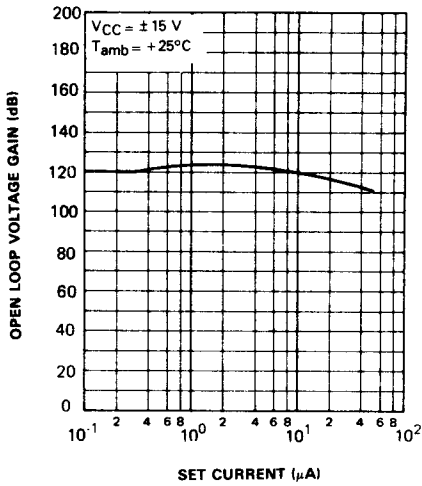

SLEW RATE vs I_{set}

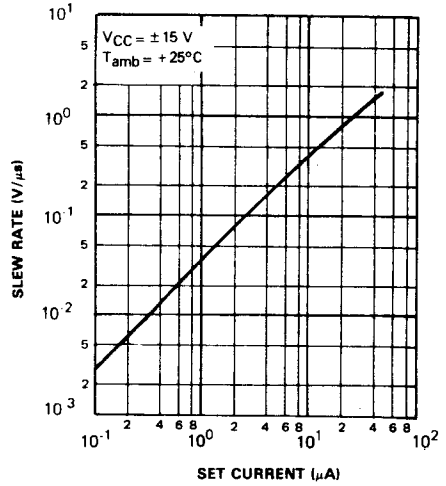

GAIN BANDWIDTH PRODUCT vs I_{set}

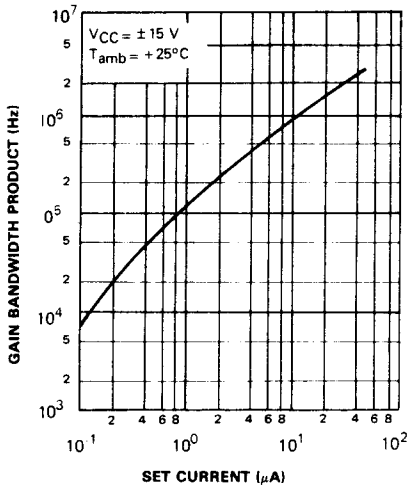

PHASE MARGIN vs I_{set}

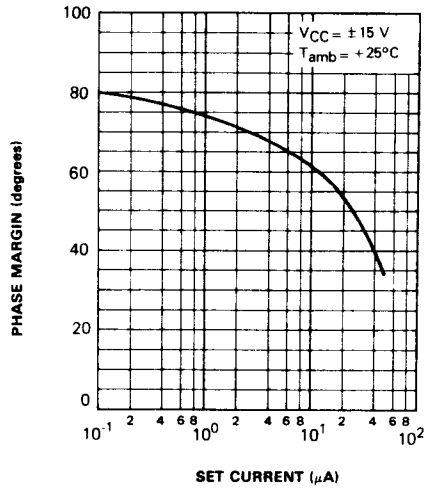

INPUT OFFSET VOLTAGE vs I_{set}

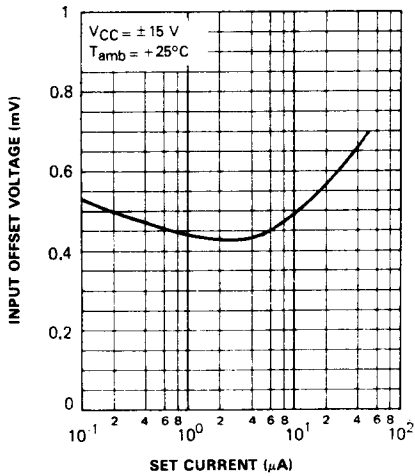

COMMON-MODE REJECTION RATIO vs I_{set}

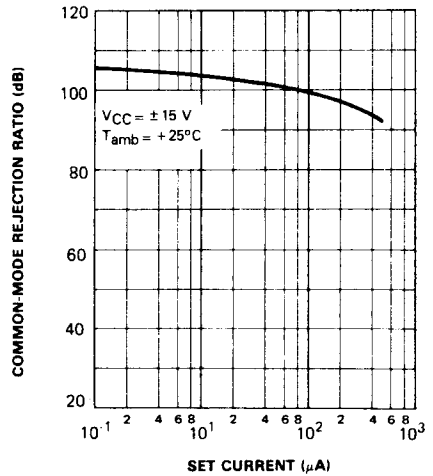

POWER SUPPLY REJECTION RATIO vs I_{set}

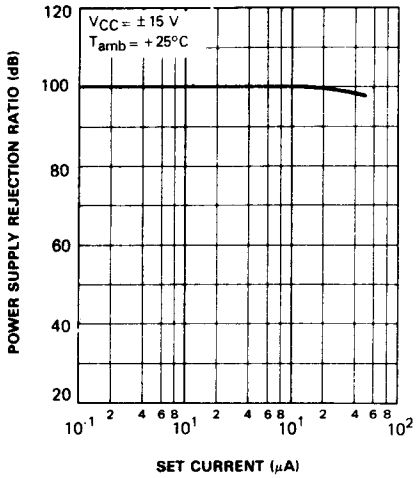

OUTPUT VOLTAGE SWING

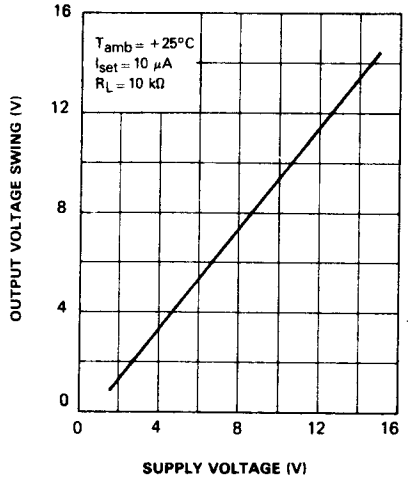

INPUT VOLTAGE RANGE

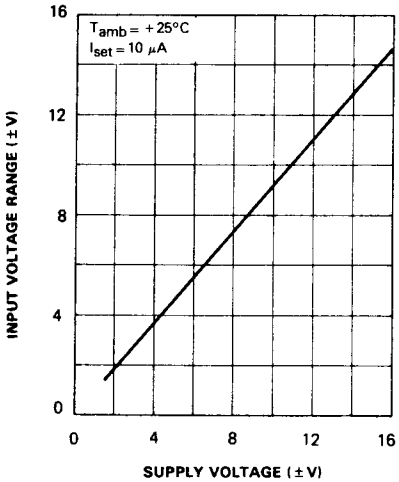

INPUT BIAS CURRENT

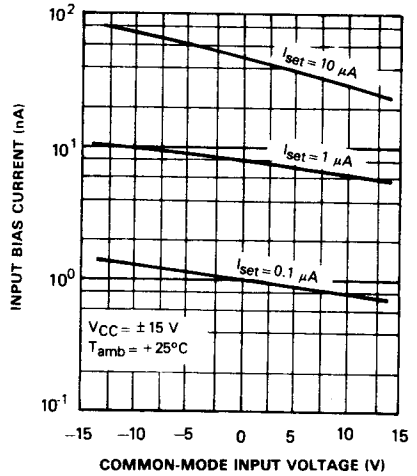

INPUT BIAS CURRENT vs TEMPERATURE

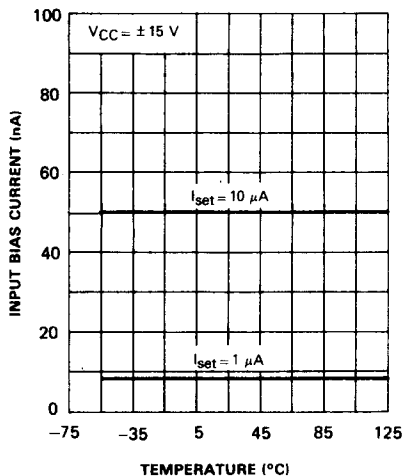

INPUT OFFSET CURRENT vs TEMPERATURE

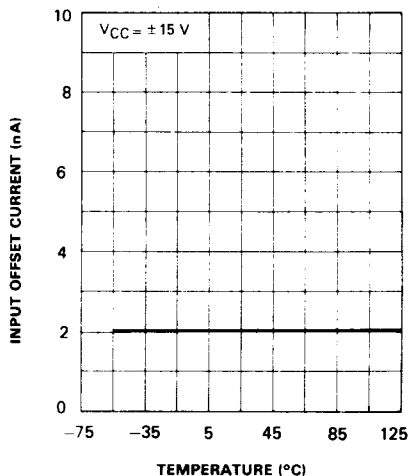

SUPPLY CURRENT vs TEMPERATURE

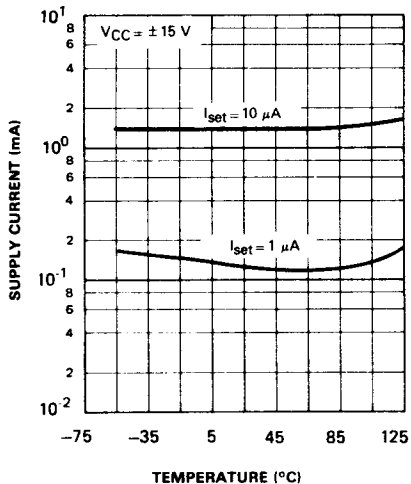

OPEN LOOP VOLTAGE GAIN vs TEMPERATURE

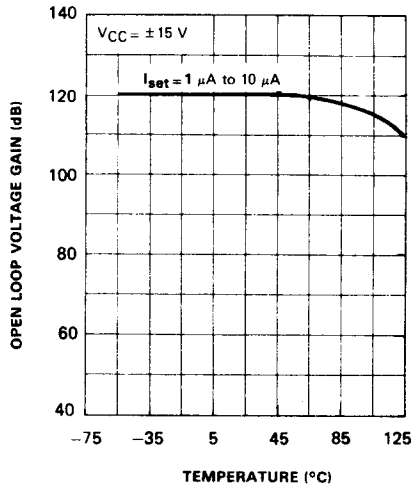

GAIN BANDWIDTH PRODUCT vs TEMPERATURE

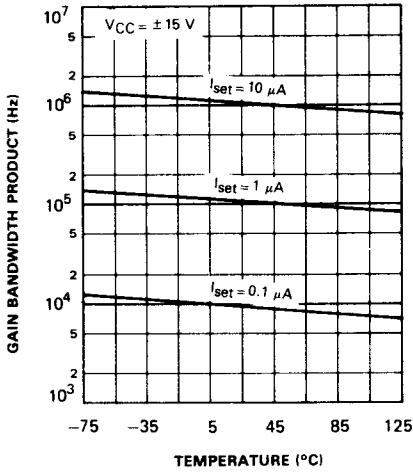

SLEW RATE vs TEMPERATURE

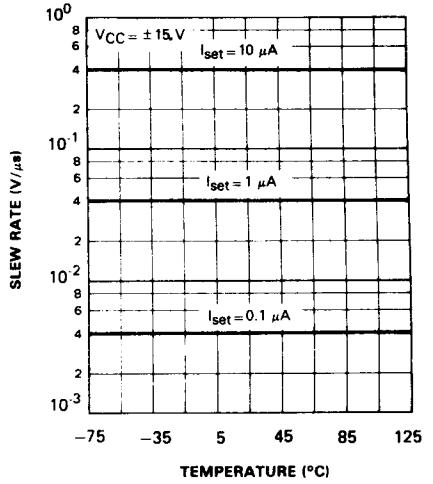

INPUT NOISE VOLTAGE vs FREQUENCY

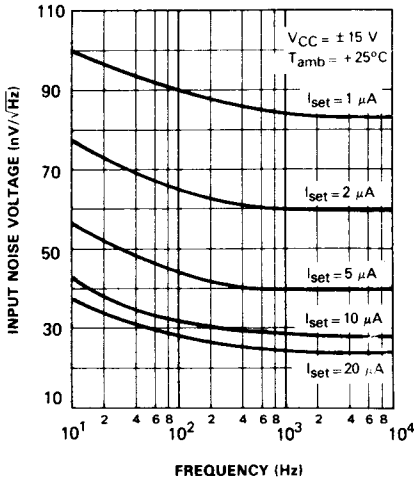

INPUT NOISE CURRENT vs FREQUENCY

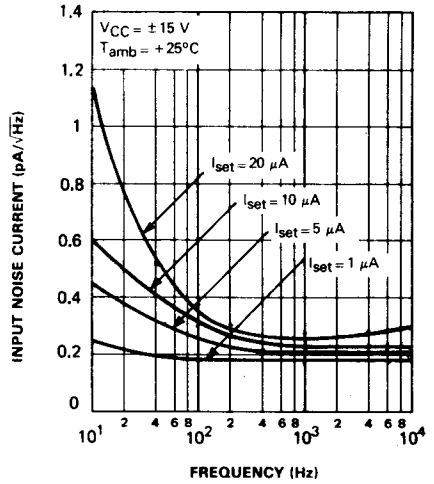

POWER SUPPLY REJECTION RATIO

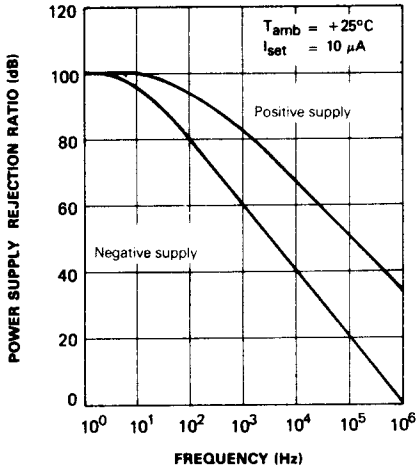

VOLTAGE FOLLOWER PULSE RESPONSE

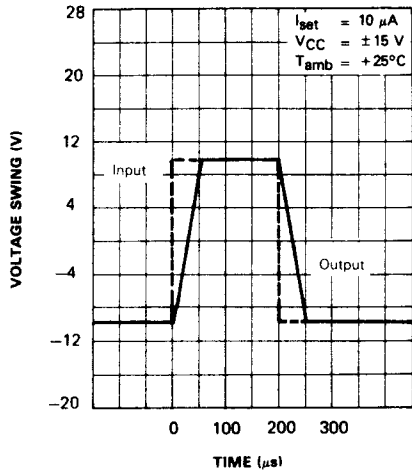

VOLTAGE FOLLOWER TRANSIENT RESPONSE

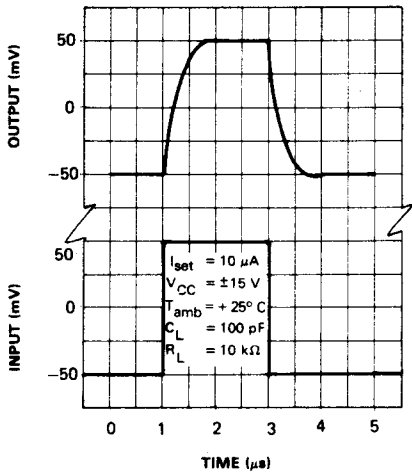

TRANSIENT RESPONSE TEST CIRCUIT

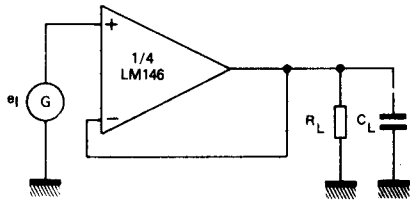

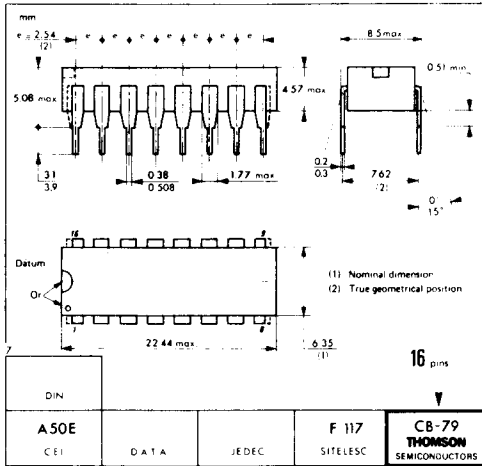

CB-79

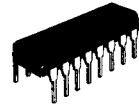

DP SUFFIX
 PLASTIC PACKAGE
 DG SUFFIX
 CERDIP PACKAGE

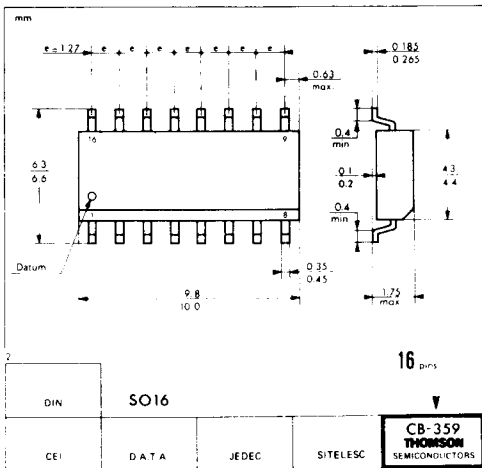

CB-359



FP SUFFIX
 PLASTIC MICROPACKAGE

CB-705



GC SUFFIX
TRICECOP (LCC)

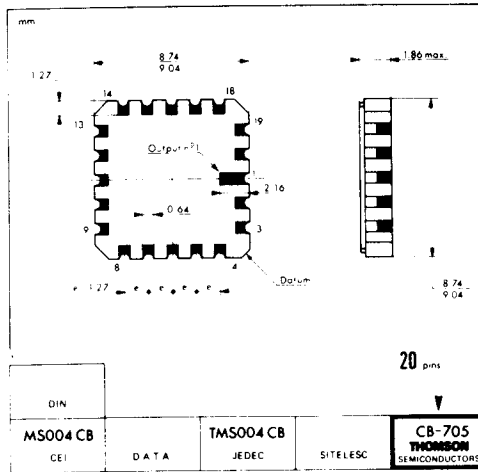

These specifications are subject to change without notice
 Please inquire with our sales offices about the availability of the different packages.