

P-Channel Enhancement Mode Power MOSFET

 Lead(Pb)-Free

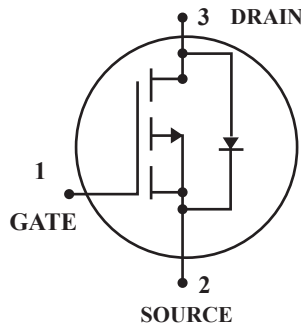

DRAIN CURRENT
-4.2 AMPERES

DRAIN SOURCE VOLTAGE
-20 VOLTAGE

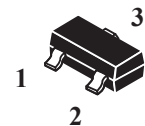

SOT-23

Features:

- *Super High Dense Cell Design For Low $R_{DS(ON)}$
 $R_{DS(ON)} < 53m\ \Omega @ V_{GS} = 10V$
- *Rugged and Reliable
- *Simple Drive Requirement
- *SOT-23 Package

Applications

- *Power Management in Notebook Computer
- *Portable Equipment
- *Battery Powered System

Maximum Ratings ($T_A = 25^\circ C$ Unless Otherwise Specified)

Rating	Symbol	Value	Unit
Drain-Source Voltage	V_{DS}	-20	V
Gate-Source Voltage	V_{GS}	± 12	
Continuous Drain Current ³ , ($T_A = 25^\circ C$) I_D , ($T_A = 70^\circ C$)	I_D	-4.2	A
		-3.4	
Pulsed Drain Current ^{1,2}	I_{DM}	-10	
Total Power Dissipation ($T_A = 25^\circ C$)	P_D	1.38	W
Maximum Thermal Resistance Junction-ambient ³	$R_{\theta JA}$	90	$^\circ C/W$
Operating Junction and Storage Temperature Range	T_J, T_{stg}	-55~+150	$^\circ C$

Device Marking

WTC2305=2305

Electrical Characteristics ($T_A = 25^\circ\text{C}$ Unless otherwise noted)

Characteristic	Symbol	Min	Typ	Max	Unit
----------------	--------	-----	-----	-----	------

Static

Drain-Source Breakdown Voltage $V_{GS}=0, I_D=-250\mu\text{A}$	$V_{(BR)DSS}$	-20	-	-	V
Gate-Source Threshold Voltage $V_{DS}=V_{GS}, I_D=-250\mu\text{A}$	$V_{GS(Th)}$	-0.5	-	-	
Gate-Source Leakage Current $V_{GS} = \pm 12\text{V}$	I_{GSS}	-	-	± 100	nA
Drain- Source Leakage Current($T_j=25^\circ\text{C}$) $V_{DS}=-20\text{V}, V_{GS}=0$	I_{DSS}	-	-	-1	μA
Drain- Source Leakage Current($T_j=70^\circ\text{C}$) $V_{DS}=-16\text{V}, V_{GS}=0$		-	-	-10	
Drain-Source On-Resistance ² $V_{GS}=-10\text{V}, I_D=-4.5\text{A}$ $V_{GS}=-4.5\text{V}, I_D=-4.2\text{A}$ $V_{GS}=-2.5\text{V}, I_D=-2.0\text{A}$ $V_{GS}=-1.8\text{V}, I_D=-1.0\text{A}$	$R_{DS(on)}$	-	-	53 65 100 250	m Ω
Forward Transconductance $V_{DS}=-5.0\text{V}, I_D=-2.8\text{A}$	g_{fs}	-	9	-	S

Dynamic

Input Capacitance $V_{GS}=0\text{V}, V_{DS}=-15\text{V}, f=1.0\text{MHz}$	C_{iss}	-	740	-	pF
Output Capacitance $V_{GS}=0\text{V}, V_{DS}=-15\text{V}, f=1.0\text{MHz}$	C_{oss}	-	167	-	
Reverse Transfer Capacitance $V_{GS}=0\text{V}, V_{DS}=-15\text{V}, f=1.0\text{MHz}$	C_{rss}	-	126	-	

Switching

Turn-on Delay Time ² $V_{DS}=-15V, V_{GS}=-10V, I_D=-4.2A, R_D=3.6\Omega, R_G=6\Omega$	$t_d(\text{on})$	-	5.9	-	ns
Rise Time $V_{DS}=-15V, V_{GS}=-10V, I_D=-4.2A, R_D=3.6\Omega, R_G=6\Omega$	t_r	-	3.6	-	
Turn-off Delay Time $V_{DS}=-15V, V_{GS}=-10V, I_D=-4.2A, R_D=3.6\Omega, R_G=6\Omega$	$t_d(\text{off})$	-	32.4	-	
Fall Time $V_{DS}=-15V, V_{GS}=-10V, I_D=-4.2A, R_D=3.6\Omega, R_G=6\Omega$	t_f	-	2.6	-	
Total Gate Charge ² $V_{DS}=-16V, V_{GS}=-4.5V, I_D=-4.2A$	Q_g	-	10.6	-	nC
Gate-Source Charge $V_{DS}=-16V, V_{GS}=-4.5V, I_D=-4.2A$	Q_{gs}	-	2.32	-	
Gate-Drain Change $V_{DS}=-16V, V_{GS}=-4.5V, I_D=-4.2A$	Q_{gd}	-	3.68	-	

Source-Drain Diode Characteristics

Forward On Voltage ² $V_{GS}=0V, I_S=-1.2A, @T_j=25^\circ\text{C}$	V_{SD}	-	-	-1.2	V
Reverse Recovery Time $V_{GS}=0, I_S=-4.2A, dl/dt=100A/\mu\text{s}$	T_{rr}	-	27.7	-	ns
Reverse Recovery Charge $V_{GS}=0, I_S=-4.2A, dl/dt=100A/\mu\text{s}$	Q_{rr}	-	22	-	nC

- Note: 1. Pulse width limited by Max, junction temperature.
 2. pulse width $\leq 300\mu\text{s}$, duty cycle $\leq 2\%$.
 3. Surface mounted on 1 in² copper pad of FR4 board; 270°C/W when mounted on min, copper pad.

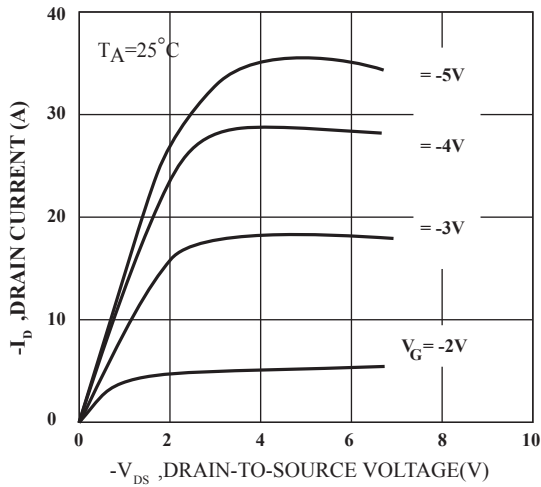

FIG.1 Typical Output Characteristics

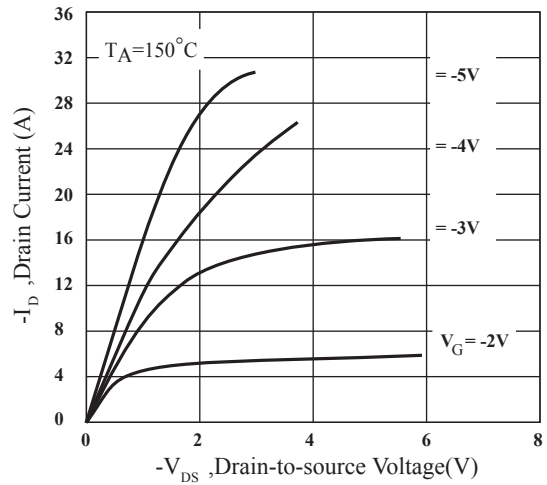

Fig.2 Typical Output Characteristics

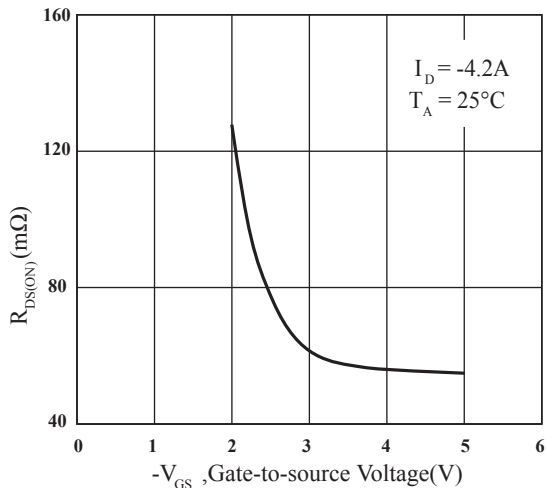

Fig.3 On-Resistance v.s. Gate Voltage

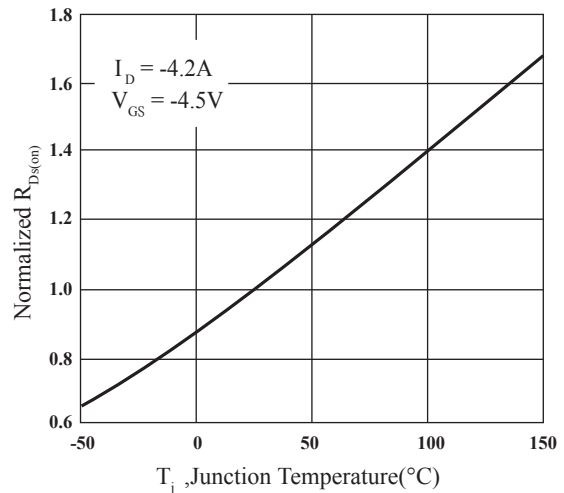

Fig.4 Normalized On-Resistance

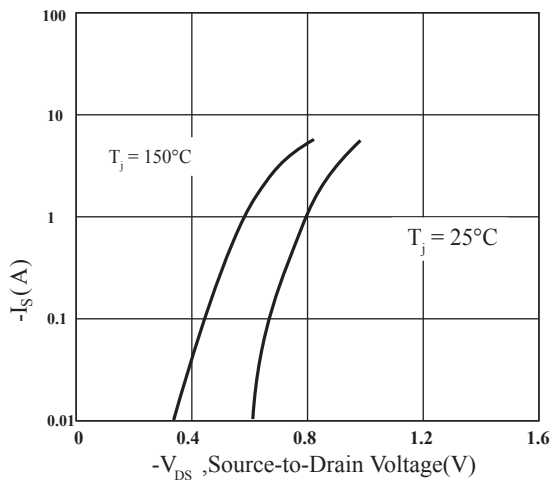

Fig.5 Forward Characteristics of Reverse Diode

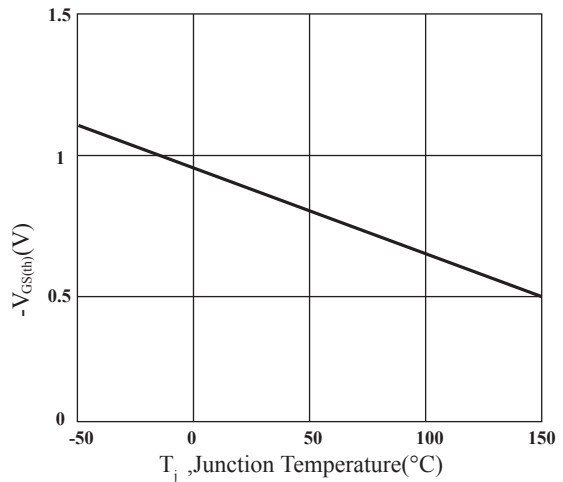

Fig.6 Gate Threshold Voltage v.s. Junction Temperature

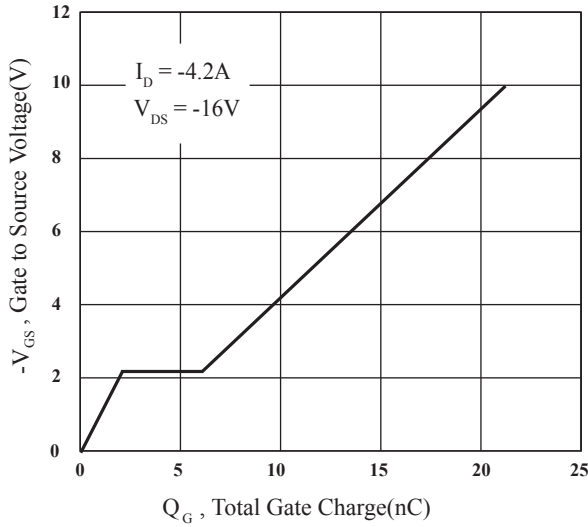

Fig 7. Gate Charge Characteristics

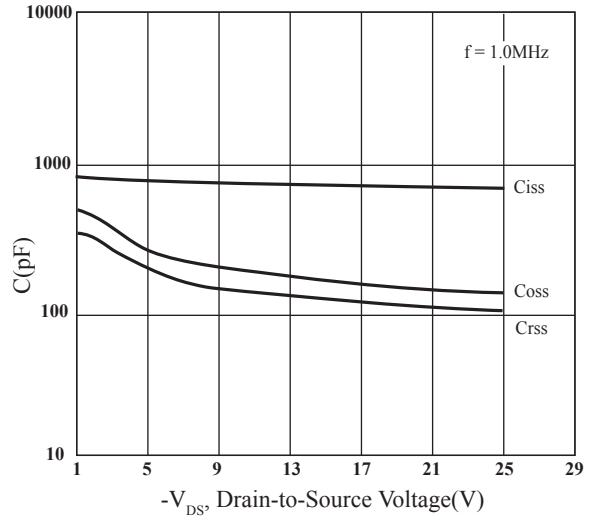

Fig 8. Typical Capacitance Characteristics

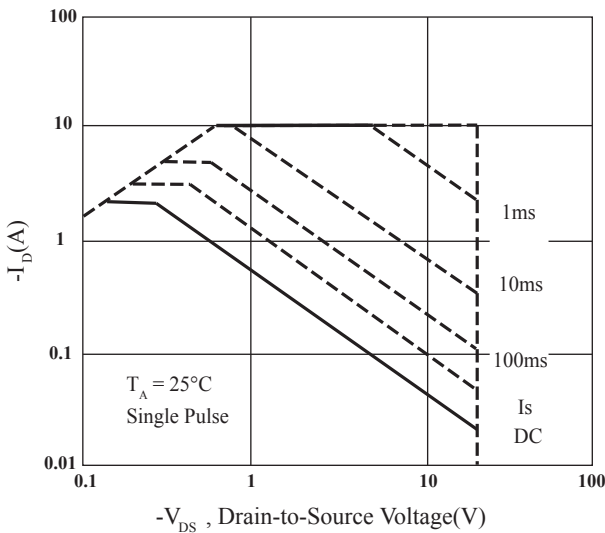

Fig 9. Maximum Safe Operation Area

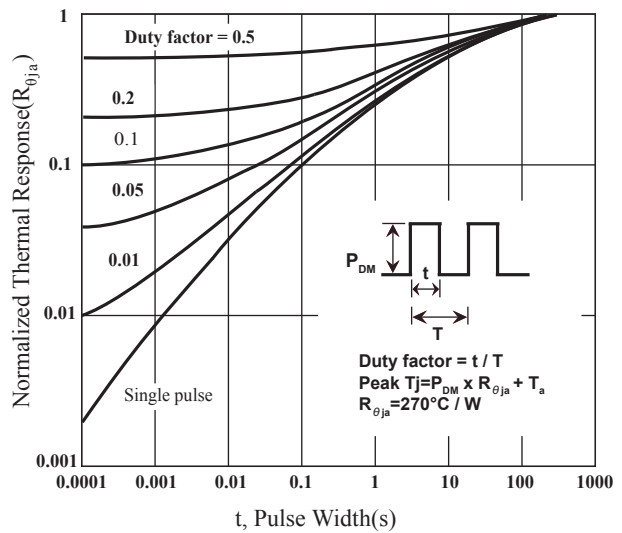

Fig 10. Effective Transient Thermal Impedance

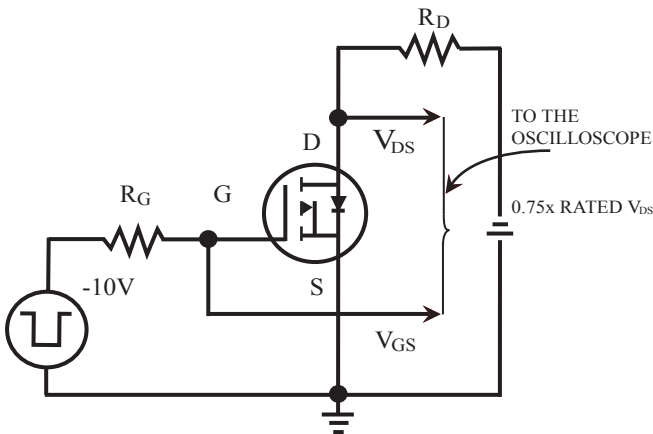

Fig 11. Switching Time Circuit

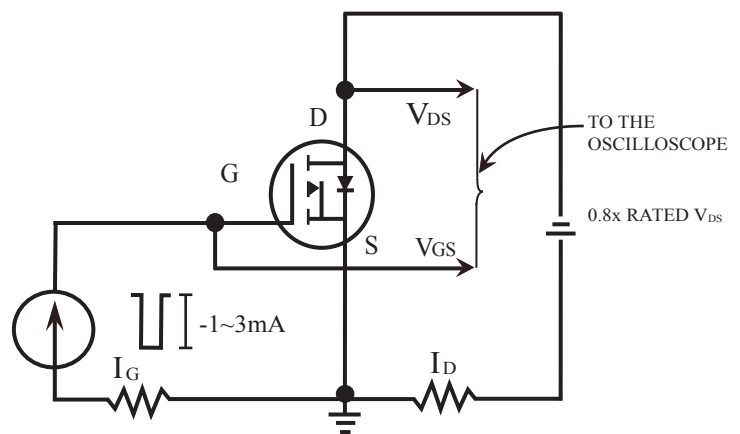

Fig.12 Gate Charge Circuit

SOT-23 Outline Dimension

