



## DYNAMIC CHARACTERISTICS

APT13GP120B\_S(G)

Symbol	Characteristic	Test Conditions	MIN	TYP	MAX	UNIT
$C_{ies}$	Input Capacitance	<b>Capacitance</b> $V_{GE} = 0V, V_{CE} = 25V$ $f = 1 \text{ MHz}$		1145		pF
$C_{oes}$	Output Capacitance			90		
$C_{res}$	Reverse Transfer Capacitance			15		
$V_{GEP}$	Gate-to-Emitter Plateau Voltage	Gate Charge		7.5		V
$Q_g$	Total Gate Charge <sup>(3)</sup>	$V_{GE} = 15V$		55		nC
$Q_{ge}$	Gate-Emitter Charge	$V_{CE} = 600V$		8		
$Q_{gc}$	Gate-Collector ("Miller") Charge	$I_C = 13A$		26		
RBSOA	Reverse Bias Safe Operating Area	$T_J = 150^\circ C, R_G = 5\Omega, V_{GE} = 15V, L = 100\mu H, V_{CE} = 960V$	50			A
$t_{d(on)}$	Turn-on Delay Time	<b>Inductive Switching (25°C)</b> $V_{CC} = 600V$ $V_{GE} = 15V$ $I_C = 13A$ $R_G = 5\Omega$ $T_J = +25^\circ C$		9		ns
$t_r$	Current Rise Time			12		
$t_{d(off)}$	Turn-off Delay Time			28		
$t_f$	Current Fall Time			34		μJ
$E_{on1}$	Turn-on Switching Energy <sup>(4)</sup>			115		
$E_{on2}$	Turn-on Switching Energy (Diode) <sup>(5)</sup>			330		
$E_{off}$	Turn-off Switching Energy <sup>(6)</sup>		165			
$t_{d(on)}$	Turn-on Delay Time	<b>Inductive Switching (125°C)</b> $V_{CC} = 600V$ $V_{GE} = 15V$ $I_C = 13A$ $R_G = 5\Omega$ $T_J = +125^\circ C$		9		ns
$t_r$	Current Rise Time			12		
$t_{d(off)}$	Turn-off Delay Time			70		
$t_f$	Current Fall Time			200		μJ
$E_{on1}$	Turn-on Switching Energy <sup>(4)</sup>			225		
$E_{on2}$	Turn-on Switching Energy (Diode) <sup>(5)</sup>			710		
$E_{off}$	Turn-off Switching Energy <sup>(6)</sup>		840			

## THERMAL AND MECHANICAL CHARACTERISTICS

Symbol	Characteristic	MIN	TYP	MAX	UNIT
$R_{\theta JC}$	Junction to Case ( <b>IGBT</b> )			.50	°C/W
$R_{\theta JC}$	Junction to Case ( <b>DIODE</b> )			N/A	
$W_T$	Package Weight		5.9		gm

① Repetitive Rating: Pulse width limited by maximum junction temperature.

② For Combi devices,  $I_{oes}$  includes both IGBT and FRED leakages

③ See MIL-STD-750 Method 3471.

④  $E_{on1}$  is the clamped inductive turn-on energy of the IGBT only, without the effect of a commutating diode reverse recovery current adding to the IGBT turn-on loss. Tested in inductive switching test circuit shown in figure 21, but with a Silicon Carbide diode.

⑤  $E_{on2}$  is the clamped inductive turn-on energy that includes a commutating diode reverse recovery current in the IGBT turn-on switching loss. (See Figures 21, 22.)

⑥  $E_{off}$  is the clamped inductive turn-off energy measured in accordance with JEDEC standard JESD24-1. (See Figures 21, 23.)

APT Reserves the right to change, without notice, the specifications and information contained herein.

**TYPICAL PERFORMANCE CURVES**

**APT13GP120B\_S(G)**

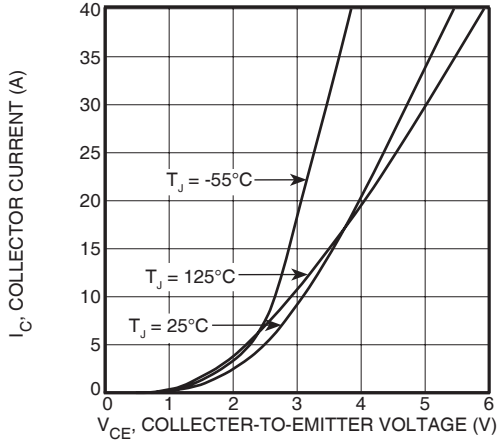

**FIGURE 1, Output Characteristics( $T_J = 25^\circ\text{C}$ )**

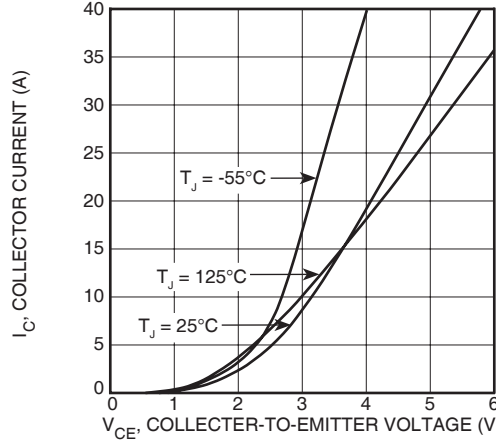

**FIGURE 2, Output Characteristics ( $T_J = 125^\circ\text{C}$ )**

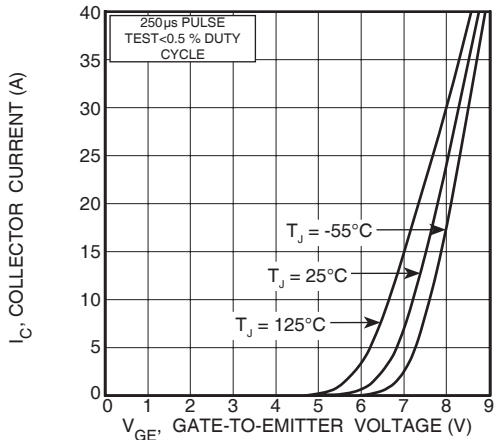

**FIGURE 3, Transfer Characteristics**

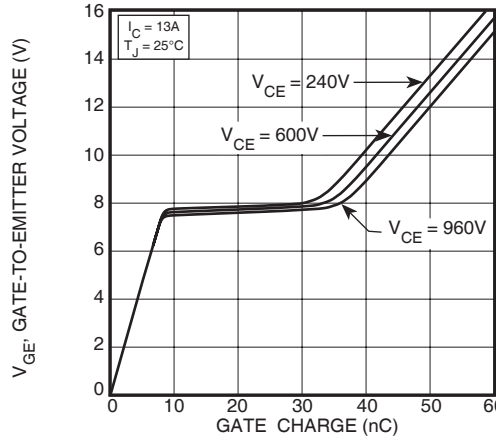

**FIGURE 4, Gate Charge**

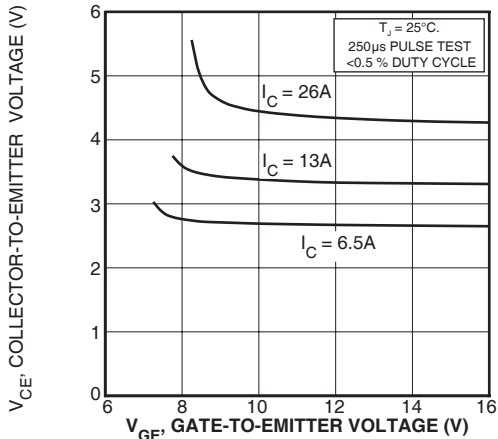

**FIGURE 5, On State Voltage vs Gate-to-Emitter Voltage**

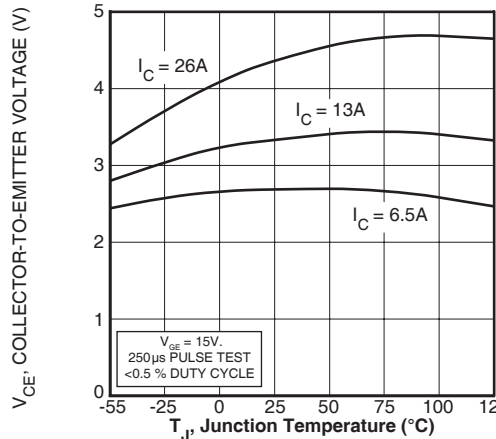

**FIGURE 6, On State Voltage vs Junction Temperature**

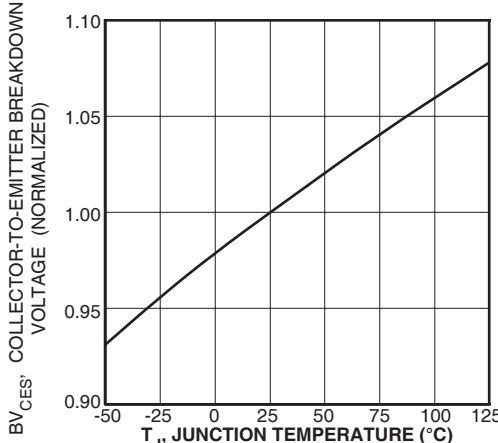

**FIGURE 7, Breakdown Voltage vs. Junction Temperature**

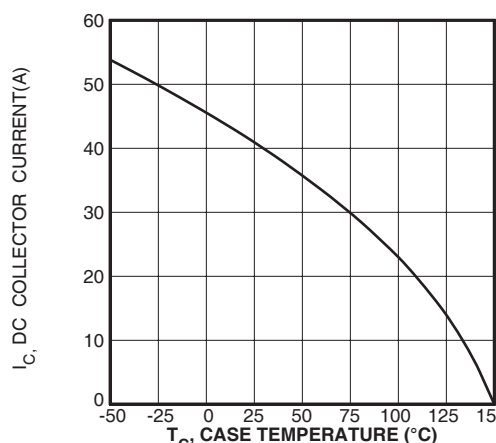

**FIGURE 8, DC Collector Current vs Case Temperature**

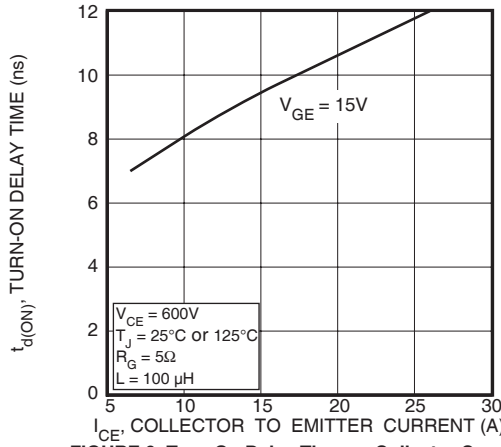

FIGURE 9, Turn-On Delay Time vs Collector Current

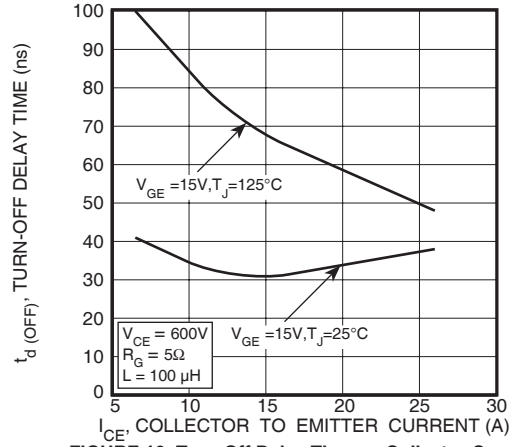

FIGURE 10, Turn-Off Delay Time vs Collector Current

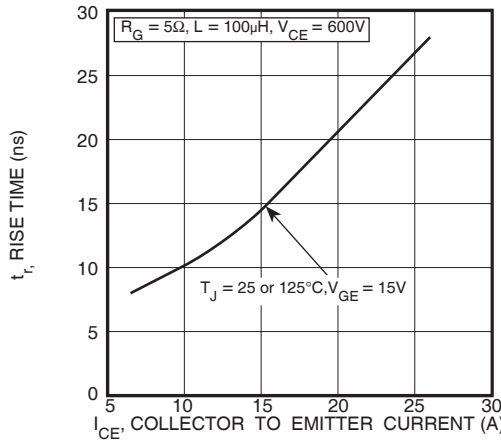

FIGURE 11, Current Rise Time vs Collector Current

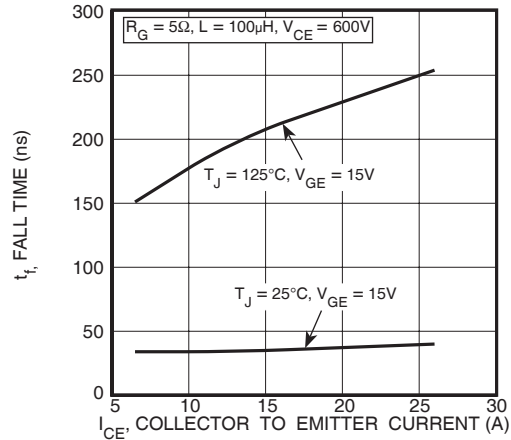

FIGURE 12, Current Fall Time vs Collector Current

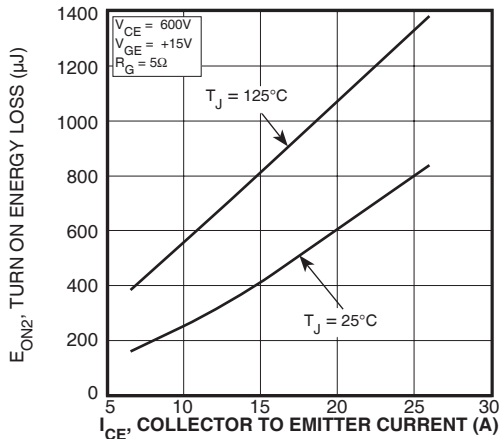

FIGURE 13, Turn-On Energy Loss vs Collector Current

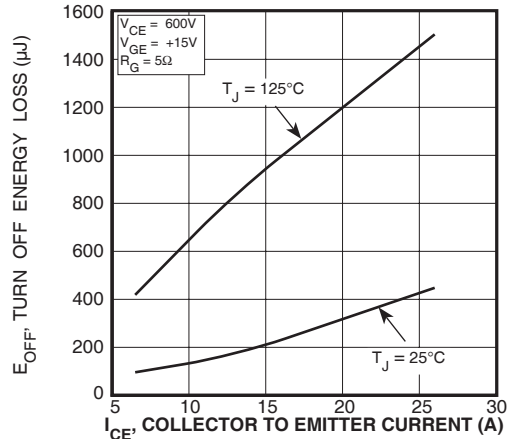

FIGURE 14, Turn Off Energy Loss vs Collector Current

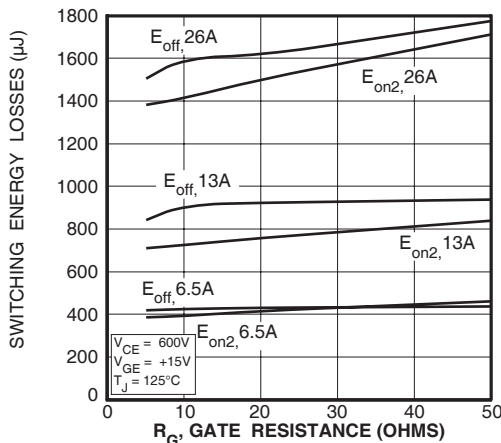

FIGURE 15, Switching Energy Losses vs. Gate Resistance

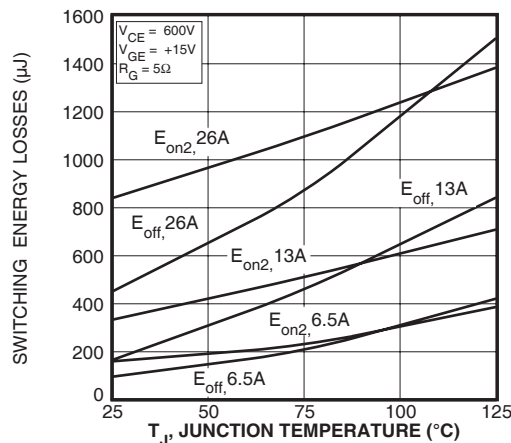

FIGURE 16, Switching Energy Losses vs Junction Temperature

# TYPICAL PERFORMANCE CURVES

APT13GP120B\_S(G)

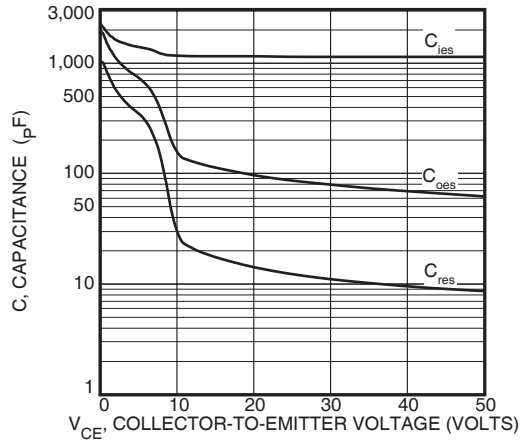

Figure 17, Capacitance vs Collector-To-Emitter Voltage

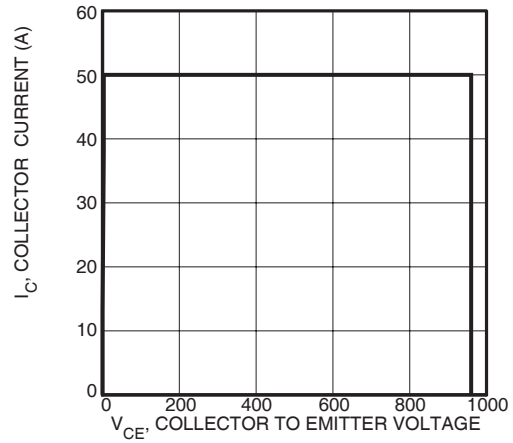

Figure 18, Minimum Switching Safe Operating Area

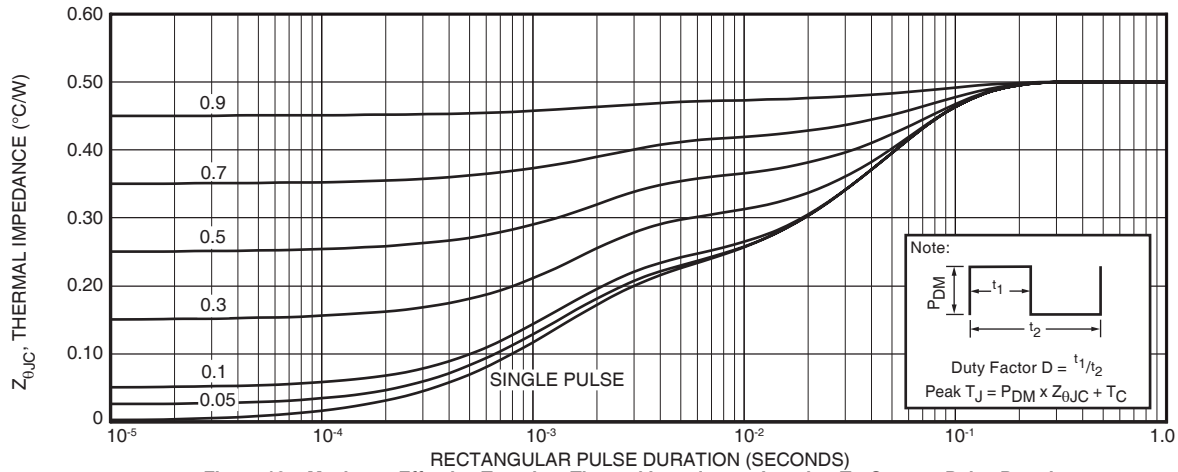

Figure 19a, Maximum Effective Transient Thermal Impedance, Junction-To-Case vs Pulse Duration

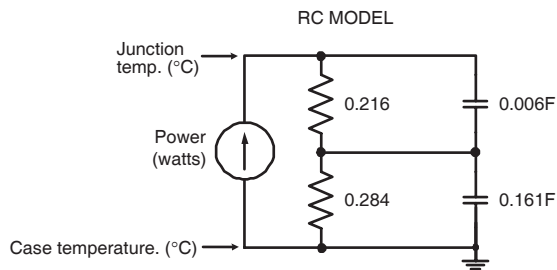

FIGURE 19b, TRANSIENT THERMAL IMPEDANCE MODEL

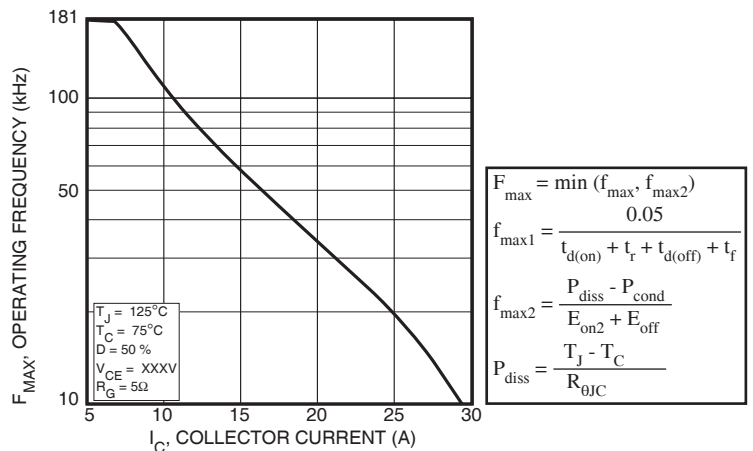

Figure 20, Operating Frequency vs Collector Current

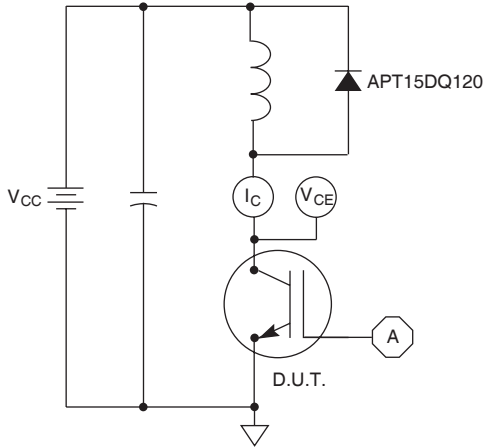

Figure 21, Inductive Switching Test Circuit

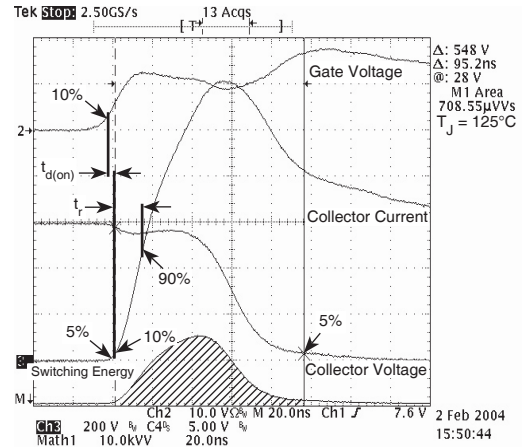

Figure 22, Turn-on Switching Waveforms and Definitions

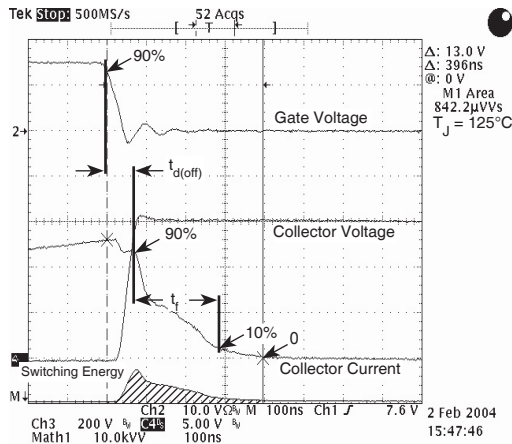
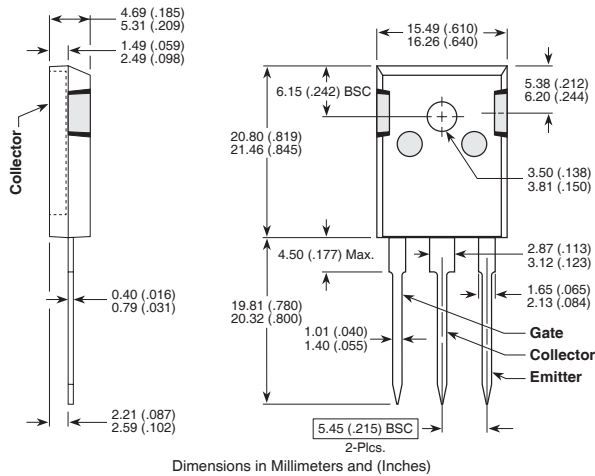

Figure 23, Turn-off Switching Waveforms and Definitions

**TO-247 Package Outline**

(e1) SAC: Tin, Silver, Copper



**TO-268 (D<sup>3</sup>) Package Outline**

(e3) SAC: Tin, Silver, Copper

