

# On-Board Type (DC) EMI Suppression Filters (EMIFIL®)



## Chip Ferrite Beads Part Numbering

### Chip Ferrite Beads

(Part Number) 

BL	M	18	AG	102	S	N	1	D
----	---	----	----	-----	---	---	---	---

#### ● Product ID

Product ID	
BL	Chip Ferrite Beads

#### ● Type

Code	Type
A	Array Type
M	Monolithic Type

#### ● Dimensions (L×W)

Code	Dimensions (L×W)	EIA
03	0.6×0.3mm	0201
15	1.0×0.5mm	0402
18	1.6×0.8mm	0603
2A	2.0×1.0mm	0804
21	2.0×1.25mm	0805
31	3.2×1.6mm	1206
41	4.5×1.6mm	1806

#### ● Characteristics/Applications

Code *1	Characteristics/Applications	Series
AG	for General Use	BLM03/BLM15/BLM18/BLM21/BLM31/BLA2A/BLA31
TG		BLM18
BA	for High-speed Signal Lines	BLM18
BB		BLM15/BLM18/BLM21/BLA2A
BD		BLM15/BLM18/BLM21/BLA2A/BLA31
PG	for Power Supplies	BLM15/BLM18/BLM21/BLM31/BLM41
RK	for Digital Interface	BLM18/BLM21
HG	for GHz Band General Use	BLM15/BLM18
EG	for GHz Band General Use (Low DC Resistance type)	
HB	for GHz Band High-speed Signal Line	BLM18
HD		BLM15/BLM18
HK	for GHz Band Digital Interface	BLM18
GG	for High-GHz Band General Use	BLM18

\*1 Frequency characteristics vary with each code.

#### ● Packaging

Code	Packaging	Series
K	Plastic Taping (ø330mm Reel)	BLM31/BLM41/BLM21 *1
L	Plastic Taping (ø190mm Reel)	
B	Bulk	All series
J	Paper Taping (ø330mm Reel)	BLM15/BLM18/BLM21*2 /BLA31
D	Paper Taping (ø190mm Reel)	BLM03/BLM15/BLM18/BLM21*2 /BLA2A/BLA31
C	Bulk Case	BLM15/BLM18

\*1 BLM21BD222SN1/BLM21BD272SN1 only.

\*2 Except BLM21BD222SN1/BLM21BD272SN1

#### ● Impedance

Expressed by three figures. The unit is in ohm (Ω). The first and second figures are significant digits, and the third figure expresses the number of zeros which follow the two figures.

#### ● Performance

Expressed by a letter.

Ex.)	Code	Performance
	S/T	Sn Plating
	A	Au Plating

#### ● Category

Code	Category
N	Standard Type
H	For Automotive

#### ● Number of Circuits

Code	Number of Circuits
1	1 Circuit
4	4 Circuits

# On-Board Type (DC) EMI Suppression Filters (EMIFIL®)



## Chip Ferrite Bead BLM Series

1

# Essential for Noise Suppression in High Speed Signal Lines and DC Power Lines

The chip ferrite bead BLM series comprises ferrite beads in the shape of a chip. This ferrite bead generates a high impedance which at high frequencies mainly consists of a resistance element. The BLM series is effective in circuits without stable ground lines because the BLM series does not need a connection to ground.

Chip sizes of 0.6x0.3, 1.0x0.5, 1.6x0.8, 2.0x1.25, 3.2x1.6 and 4.5x1.6mm are cataloged. (The BLA series of array type chip ferrite beads is also cataloged.)

The nickel barrier structure of the external electrodes provides excellent solder heat resistance.

### ■ Features

The BLM series comprises the R series (for digital interface), the A series (for standard), the B series (for high speed signal), the P series (for large current), and the H/E/G series (for GHz range noise suppression).

#### 1. BLM□□R series – For Digital Interface

The BLM-R series can be used in Digital Interface.

Resistance of BLM-R series especially grows in the lower frequency range. Therefore BLM-R series is less effective for digital signal waveform at low frequency range and can suppress the ringing.

#### 2. BLM□□A/T series – For Standard

The BLM-A series generates an impedance from the relatively low frequencies. Therefore the BLM-A series is effective in noise suppression in the wide frequency range (30MHz – several hundred MHz).

#### 3. BLM□□B series – For High Speed Signal

The BLM-B series can minimize attenuation of the signal waveform due to its sharp impedance characteristics. Various impedances are available to match signal frequency.

#### 4. BLM□□P series – For Large Current

The BLM-P series can be used in high current circuits due to its low DC resistance. It can match power lines to a maximum of 6A DC (BLM41P).

#### 5. BLM□□H/E/G series – For GHz Range Noise Suppression

The BLM□□H/E/G series has a modified internal electrode structure that minimizes stray capacitance and increases the effective frequency range.

[Impedance Characteristics]

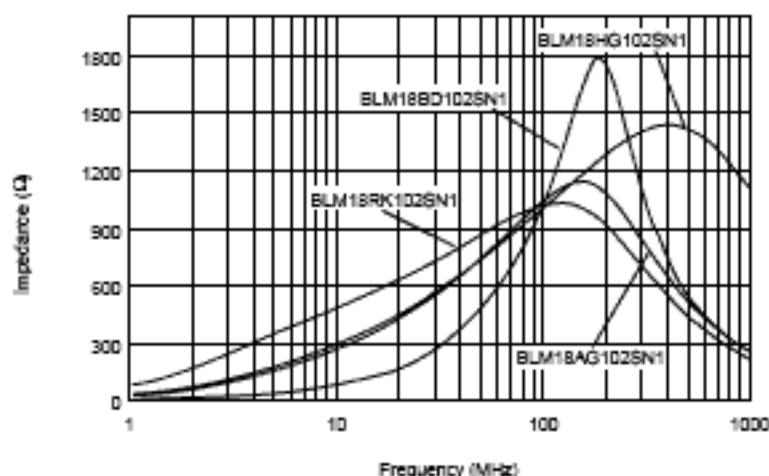

## ■ Impedance Map

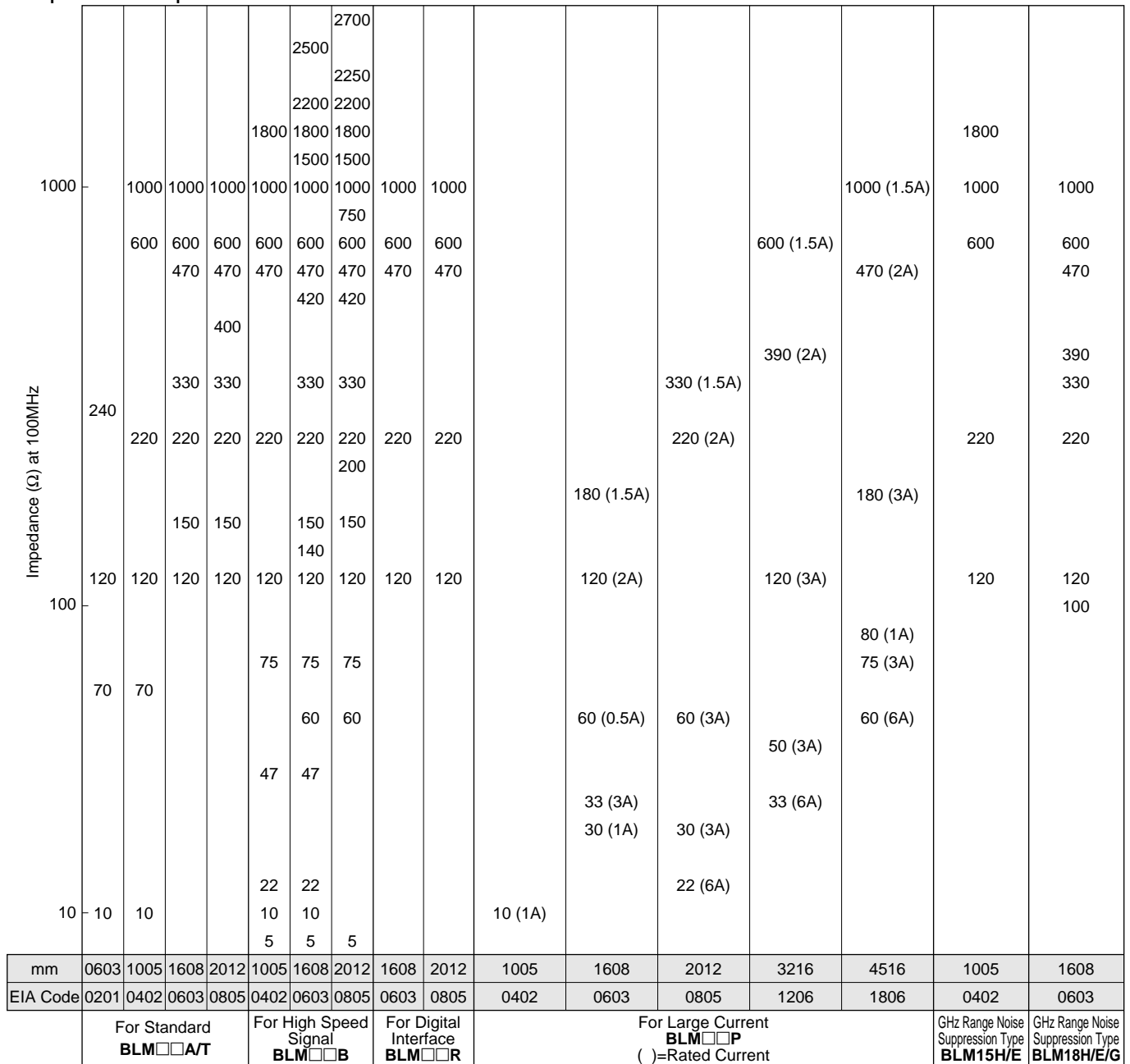

1

■BLM Series

Size (EIA Code)	Type	Part Number	Impedance (Ω)		Rated Current (mA)
			at 100MHz	at 1GHz	
0201	For Standard	BLM03AG100SN1	10 (Typ.)	-	500
		BLM03AG700SN1	70 (Typ.)	-	200
		BLM03AG121SN1	120±25%	-	200
		BLM03AG241SN1	240±25%	-	100
0402	For Standard	BLM15AG100SN1	10 (Typ.)	-	1000
		BLM15AG700SN1	70 (Typ.)	-	500
		BLM15AG121SN1	120±25%	-	300
		BLM15AG221SN1	220±25%	-	300
		BLM15AG601SN1	600±25%	-	200
		BLM15AG102SN1	1000±25%	-	200
		BLM15AG601AN1	600±25%	140 (Typ.)	300
		BLM15AG102AN1	1000±25%	300 (Typ.)	200
	For High Speed Signal (Sharp impedance characteristics)	BLM15BB050SN1	5±25%	-	500
		BLM15BB100SN1	10±25%	-	300
		BLM15BB220SN1	22±25%	-	
		BLM15BB470SN1	47±25%	-	
		BLM15BB750SN1	75±25%	-	
		BLM15BB121SN1	120±25%	-	200
		BLM15BB221SN1	220±25%	-	
		BLM15BD750SN1	75±25%	-	300
		BLM15BD121SN1	120±25%	-	
		BLM15BD221SN1	220±25%	-	200
		BLM15BD471SN1	470±25%	-	
		BLM15BD601SN1	600±25%	-	100
	BLM15BD102SN1	1000±25%	-	100	
	BLM15BD182SN1	1800±25%	-	100	
	For Large Current	BLM15PG100SN1	10 (Typ.)	-	1000
	GHz Range	For Standard	BLM15HG601SN1	600±25%	1000±40%
BLM15HG102SN1			1000±25%	1400±40%	250
For High Speed Signal		BLM15HD601SN1	600±25%	1400±40%	300
		BLM15HD102SN1	1000±25%	2000±40%	250
For Standard (Low DC Resistance Type)		BLM15HD182SN1	1800±25%	2700±40%	200
		BLM15EG121SN1	120±25%	145 (Typ.)	1500*
BLM15EG221SN1	220±25%	270 (Typ.)	700*		
0603	For Standard	BLM18AG121SN1	120±25%	-	200
		BLM18AG151SN1	150±25%	-	
		BLM18AG221SN1	220±25%	-	
		BLM18AG331SN1	330±25%	-	
		BLM18AG471SN1	470±25%	-	
		BLM18AG601SN1	600±25%	-	
		BLM18AG102SN1	1000±25%	-	100
	For High Speed Signal (Sharp impedance characteristics)	BLM18BA050SN1	5±25%	-	500
		BLM18BB050SN1		-	700
		BLM18BA100SN1	10±25%	-	500
		BLM18BB100SN1		-	
		BLM18BA220SN1	22±25%	-	300
		BLM18BB220SN1		-	
		BLM18BA470SN1	47±25%	-	500
		BLM18BB470SN1		-	
		BLM18BB600SN1	60±25%	-	200
		BLM18BA750SN1	75±25%	-	300
		BLM18BB750SN1		-	200
		BLM18BA121SN1	120±25%	-	200
		BLM18BB121SN1		-	
BLM18BD121SN1	-				
BLM18BB141SN1	140±25%	-			

\* Please see P.58 "Derating of Rated Current".

Continued from the preceding page.

Size (EIA Code)	Type		Part Number	Impedance (Ω)		Rated Current (mA)		
				at 100MHz	at 1GHz			
0603	For High Speed Signal (Sharp impedance characteristics)		BLM18BB151SN1	150±25%	-	200		
			BLM18BD151SN1		-			
			BLM18BB221SN1	220±25%	-			
			BLM18BD221SN1		-			
			BLM18BB331SN1	330±25%	-			
			BLM18BD331SN1		-			
			BLM18BD421SN1	420±25%	-			
			BLM18BB471SN1	470±25%	-	50		
			BLM18BD471SN1		-	200		
			BLM18BD601SN1	600±25%	-	200		
			BLM18BD102SN1	1000±25%	-	100		
			BLM18BD152SN1	1500±25%	-	50		
			BLM18BD182SN1	1800±25%	-			
			BLM18BD222SN1	2200±25%	-			
			BLM18BD252SN1	2500±25%	-			
			For Digital Interface		BLM18RK121SN1	120±25%	-	200
	BLM18RK221SN1	220±25%			-			
	BLM18RK471SN1	470±25%			-			
	BLM18RK601SN1	600±25%			-			
	BLM18RK102SN1	1000±25%			-			
	For Large Current		BLM18PG300SN1	30 (Typ.)	-	1000		
			BLM18PG330SN1	33±25%	-	3000*		
			BLM18PG600SN1	60 (Typ.)	-	500		
			BLM18PG121SN1	120±25%	-	2000*		
			BLM18PG181SN1	180±25%	-	1500*		
	GHz Range		For Standard		BLM18HG471SN1	470±25%	600 (Typ.)	200
					BLM18HG601SN1	600±25%	700 (Typ.)	
					BLM18HG102SN1	1000±25%	1000 (Typ.)	
			For High Speed Signal		BLM18HB121SN1	120±25%	500±40%	200
					BLM18HB221SN1	220±25%	1100±40%	100
					BLM18HB331SN1	330±25%	1600±40%	50
					BLM18HD471SN1	470±25%	1000 (Typ.)	100
					BLM18HD601SN1	600±25%	1200 (Typ.)	
					BLM18HD102SN1	1000±25%	1700 (Typ.)	50
			For Digital Interface		BLM18HK331SN1	330±25%	400±40%	200
					BLM18HK471SN1	470±25%	600±40%	
					BLM18HK601SN1	600±25%	700±40%	100
					BLM18HK102SN1	1000±25%	1200±40%	50
			For Standard (Low DC Resistance Type)		BLM18EG101TN1	100±25%	140 (Typ.)	2000*
					BLM18EG121SN1	120±25%	145 (Typ.)	2000*
					BLM18EG221TN1	220±25%	300 (Typ.)	1000
					BLM18EG331TN1	330±25%	450 (Typ.)	500
BLM18EG391TN1					390±25%	520 (Typ.)	500	
BLM18EG471SN1	470±25%	550 (Typ.)			500			
BLM18EG601SN1	600±25%	700 (Typ.)			500			
BLM18GG471SN1	470±25%	1800±30%	100					
0805		For Standard		BLM21AG121SN1	120±25%	-	200	
				BLM21AG151SN1	150±25%	-		
				BLM21AG221SN1	220±25%	-		
				BLM21AG331SN1	330±25%	-		
				BLM21AG471SN1	470±25%	-		
				BLM21AG601SN1	600±25%	-		
				BLM21AG102SN1	1000±25%	-		

\* Please see P.53 "Derating of Rated Current".

Continued on the following page. ↗

Continued from the preceding page.

Size (inches)	Type	Part Number	Impedance (Ω)		Rated Current (mA)
			at 100MHz	at 1GHz	
0805	For High Speed Signal (Sharp impedance characteristics)	BLM21BB050SN1	5±25%	-	500
		BLM21BB600SN1	60±25%	-	200
		BLM21BB750SN1	75±25%	-	
		BLM21BB121SN1	120±25%	-	
		BLM21BD121SN1		-	
		BLM21BB151SN1	150±25%	-	
		BLM21BD151SN1		-	
		BLM21BB201SN1	200±25%	-	
		BLM21BB221SN1	220±25%	-	
		BLM21BD221SN1		-	
		BLM21BB331SN1	330±25%	-	
		BLM21BD331SN1		-	
		BLM21BD421SN1	420±25%	-	
		BLM21BB471SN1	470±25%	-	
		BLM21BD471SN1		-	
		BLM21BD601SN1	600±25%	-	
		BLM21BD751SN1	750±25%	-	
		BLM21BD102SN1	1000±25%	-	
		BLM21BD152SN1	1500±25%	-	
		BLM21BD182SN1	1800±25%	-	
	BLM21BD222SN1	2250 (Typ.)	-		
	BLM21BD222TN1	2200±25%	-		
	BLM21BD272SN1	2700±25%	-		
	For Digital Interface	BLM21RK121SN1	120±25%	-	200
		BLM21RK221SN1	220±25%	-	
		BLM21RK471SN1	470±25%	-	
		BLM21RK601SN1	600±25%	-	
		BLM21RK102SN1	1000±25%	-	
	For Large Current	BLM21PG220SN1	22±25%	-	6000*
		BLM21PG300SN1	30 (Typ.)	-	3000*
		BLM21PG600SN1	60±25%	-	2000*
		BLM21PG221SN1	220±25%	-	1500*
1206	For Large Current	BLM21PG331SN1	330±25%	-	6000*
		BLM31PG330SN1	33±25%	-	3000*
		BLM31PG500SN1	50 (Typ.)	-	
		BLM31PG121SN1	120±25%	-	2000*
		BLM31PG391SN1	390±25%	-	1500*
1806	For Large Current	BLM31PG601SN1	600±25%	-	6000*
		BLM41PG600SN1	60 (Typ.)	-	3000*
		BLM41PG750SN1	75 (Typ.)	-	3000*
		BLM41PG181SN1	180±25%	-	2000*
		BLM41PG471SN1	470±25%	-	1500*
		BLM41PG102SN1	1000±25%	-	1500*

\* Please see P.53 "Derating of Rated Current".

# On-Board Type (DC) EMI Suppression Filters (EMIFIL®)



## Chip Ferrite Beads BLM03/BLM15/BLM18/BLM21/BLM31/BLM41 Series

### ■ Features (BLM\_A Series)

The chip ferrite bead BLM series comprises ferrite beads in the shape of a chip. This ferrite bead generates a high impedance which at high frequency mainly consists of a resistance element. The BLM series is effective in circuits without stable ground lines because the BLM series does not need a connection to ground.

The nickel barrier structure of the external electrodes provides excellent solder heat resistance. BLM\_A series generates an impedance from the relatively low frequencies. Therefore BLM\_A series is effective in noise suppression in a wide frequency range (30MHz - several hundred MHz).

The small size of BLM03 series (0.6x0.3mm) is suitable for noise suppression in small equipment such as PA modules for cellular phones.

### ■ Equivalent Circuit

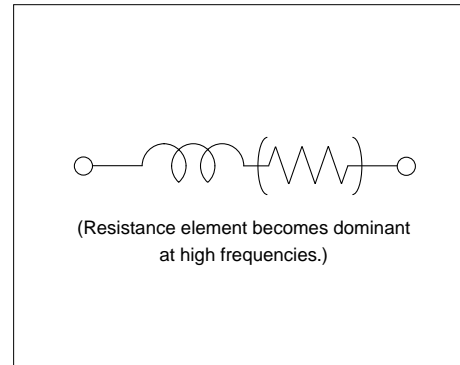

### BLM03A Series (0201 Size)

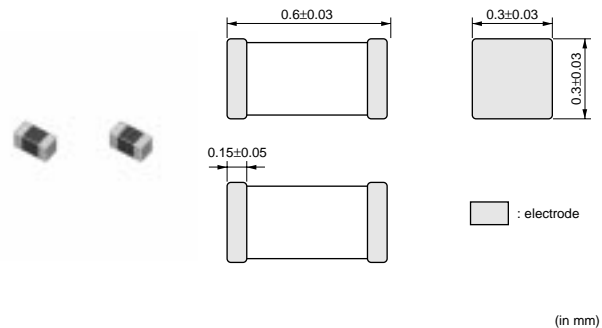

Part Number	Impedance (at 100MHz/20°C) (ohm)	Rated Current (mA)	DC Resistance (max.) (ohm)	Operating Temperature Range (°C)
BLM03AG100SN1	10 (Typ.)	500	0.1	-55 to +125
BLM03AG700SN1	70 (Typ.)	200	0.5	-55 to +125
BLM03AG121SN1	120 ±25%	200	0.8	-55 to +125
BLM03AG241SN1	240 ±25%	100	1.0	-55 to +125

## ■ Impedance-Frequency (Typical)

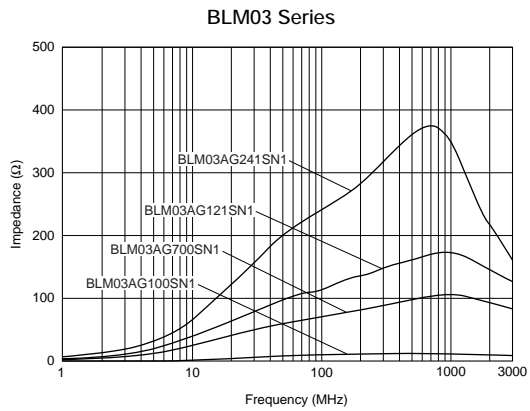

## ■ Impedance-Frequency Characteristics

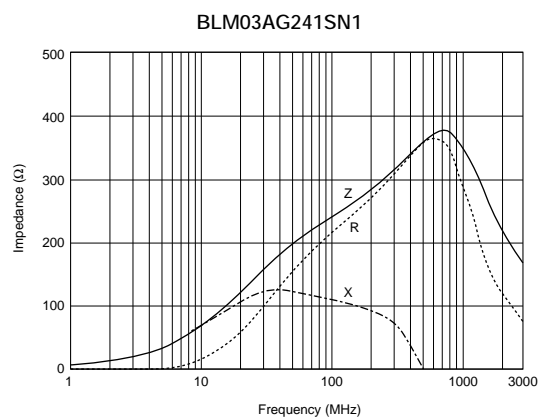
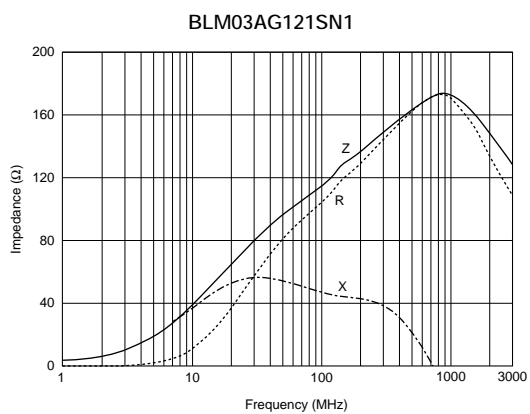
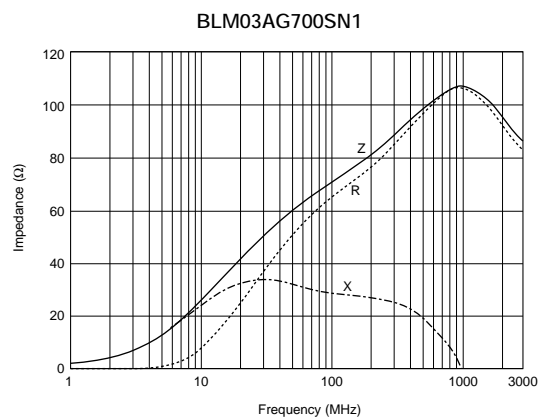
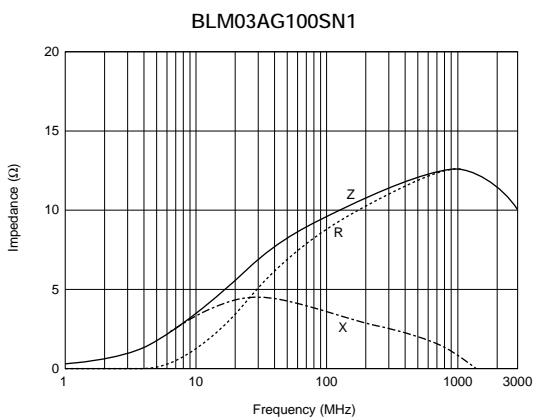

## BLM15A Series (0402 Size)

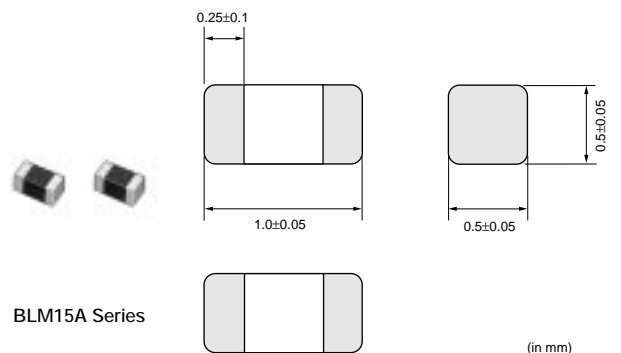



Part Number	Impedance (at 100MHz/20°C) (ohm)	Rated Current (mA)	DC Resistance (max.) (ohm)	Operating Temperature Range (°C)
<b>BLM15AG100SN1</b>	10 (Typ.)	1000	0.05	-55 to +125
<b>BLM15AG700SN1</b>	70 (Typ.)	500	0.15	-55 to +125
<b>BLM15AG121SN1</b>	120 ±25%	500	0.25	-55 to +125
<b>BLM15AG221SN1</b>	220 ±25%	300	0.35	-55 to +125
<b>BLM15AG601SN1</b>	600 ±25%	300	0.6	-55 to +125
<b>BLM15AG102SN1</b>	1000 ±25%	200	1.0	-55 to +125

■ Impedance-Frequency (Typical)

BLM15A Series

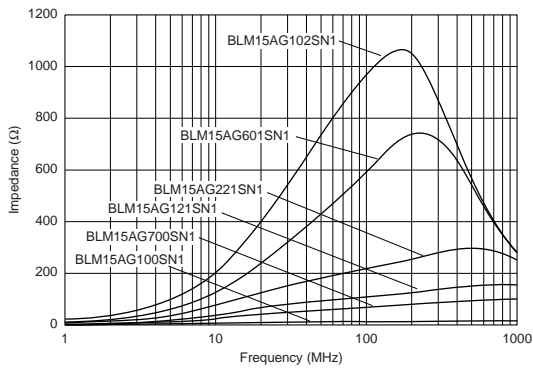

■ Impedance-Frequency Characteristics

BLM15AG100SN1

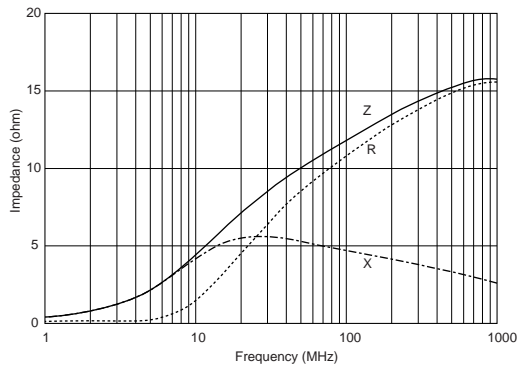

BLM15AG700SN1

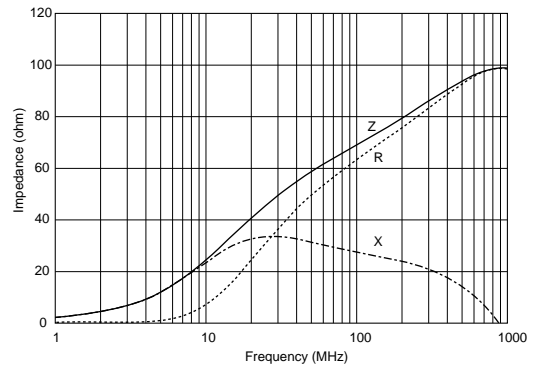

BLM15AG121SN1

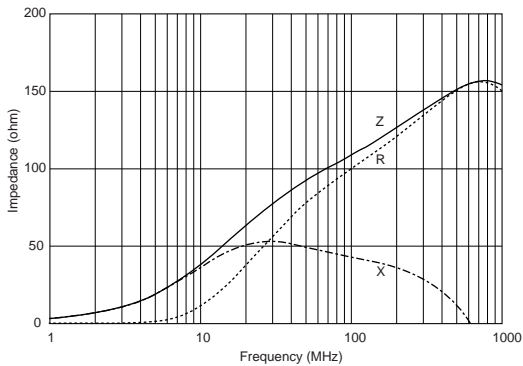

BLM15AG221SN1

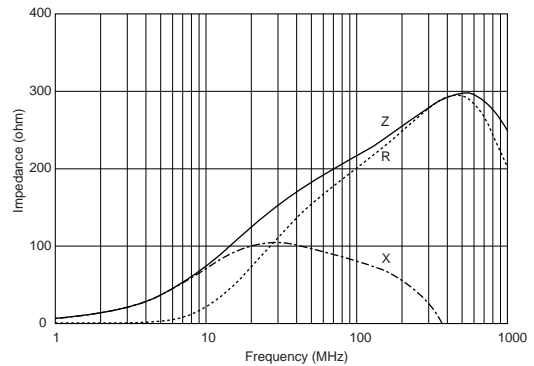

Continued on the following page. ↗

Continued from the preceding page.

### Impedance-Frequency Characteristics

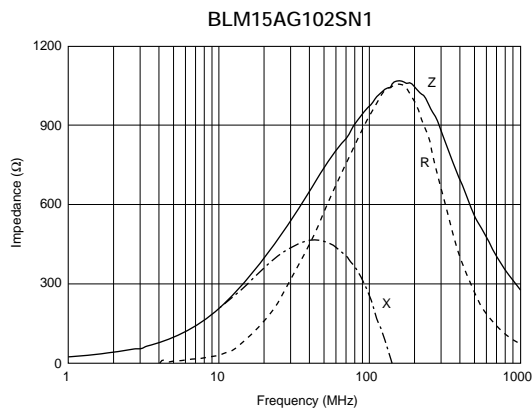
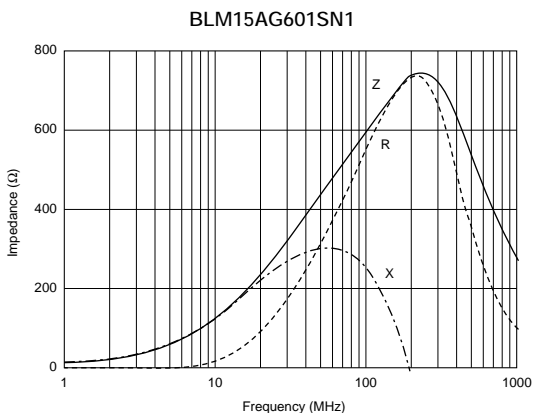

### BLM18A Series (0603 Size)

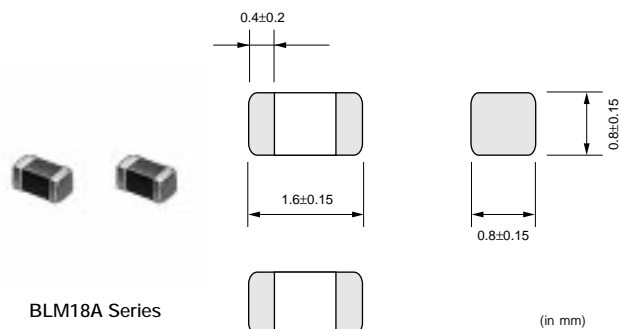

Part Number	Impedance (at 100MHz/20°C) (ohm)	Rated Current (mA)	DC Resistance (max.) (ohm)	Operating Temperature Range (°C)
BLM18AG121SN1	120 ±25%	200	0.20	-55 to +125
BLM18AG151SN1	150 ±25%	200	0.25	-55 to +125
BLM18AG221SN1	220 ±25%	200	0.30	-55 to +125
BLM18AG331SN1	330 ±25%	200	0.45	-55 to +125
BLM18AG471SN1	470 ±25%	200	0.50	-55 to +125
BLM18AG601SN1	600 ±25%	200	0.50	-55 to +125
BLM18AG102SN1	1000 ±25%	100	0.70	-55 to +125

### Impedance-Frequency (Typical)

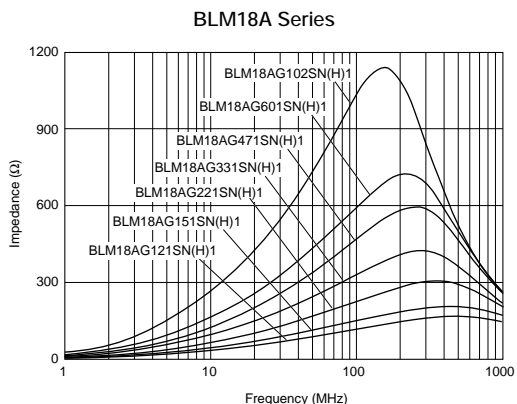

## ■ Impedance-Frequency Characteristics

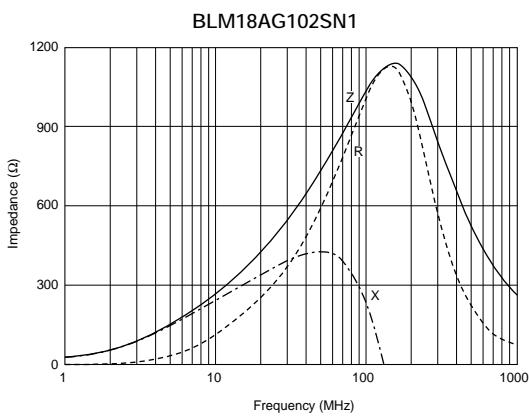
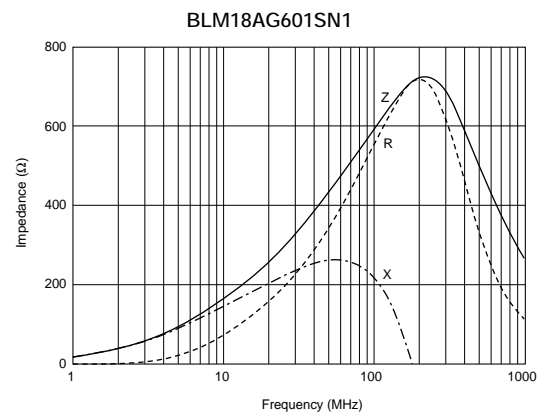
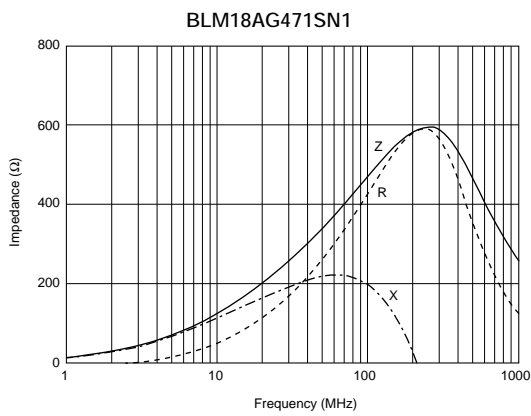
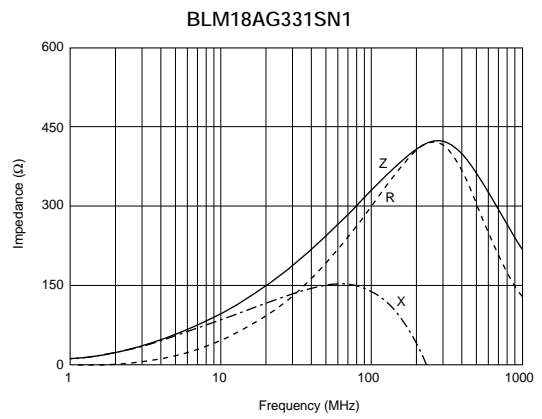
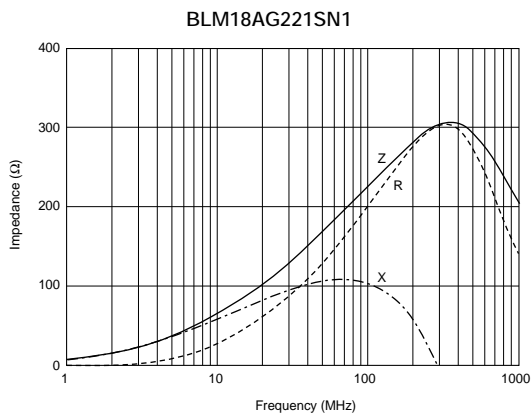
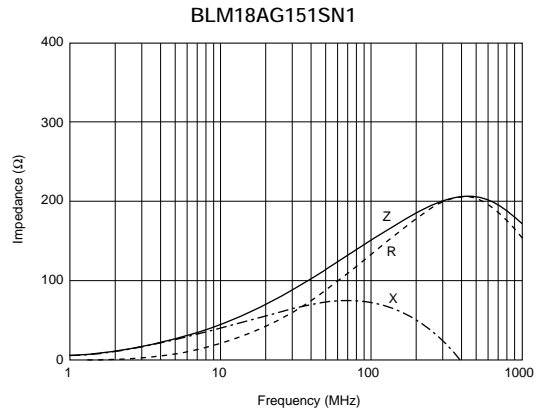
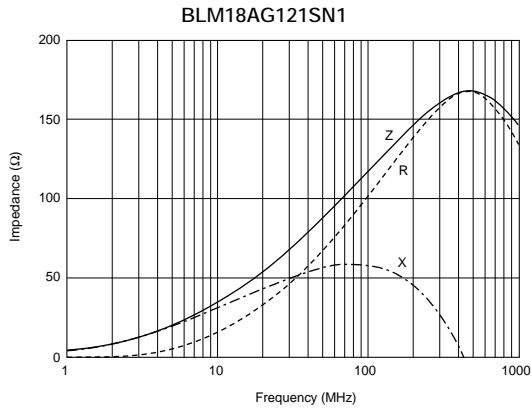

1

**BLM21A Series (0805 Size)**

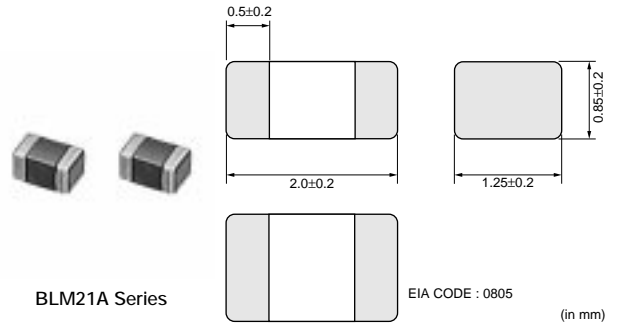

Part Number	Impedance (at 100MHz/20°C) (ohm)	Rated Current (mA)	DC Resistance (max.) (ohm)	Operating Temperature Range (°C)
<b>BLM21AG121SN1</b>	120 ±25%	200	0.15	-55 to +125
<b>BLM21AG151SN1</b>	150 ±25%	200	0.15	-55 to +125
<b>BLM21AG221SN1</b>	220 ±25%	200	0.20	-55 to +125
<b>BLM21AG331SN1</b>	330 ±25%	200	0.25	-55 to +125
<b>BLM21AG471SN1</b>	470 ±25%	200	0.25	-55 to +125
<b>BLM21AG601SN1</b>	600 ±25%	200	0.30	-55 to +125
<b>BLM21AG102SN1</b>	1000 ±25%	200	0.45	-55 to +125

■ Impedance-Frequency (Typical)

BLM21A Series

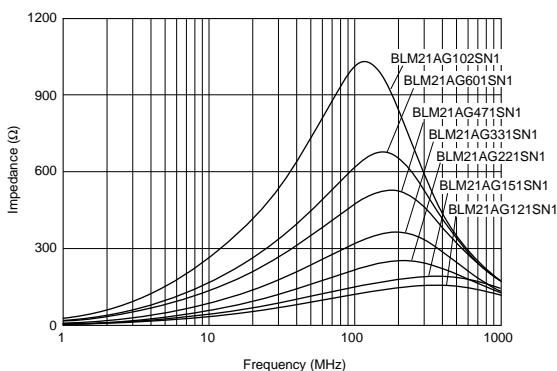

■ Impedance-Frequency Characteristics

BLM21AG121SN1

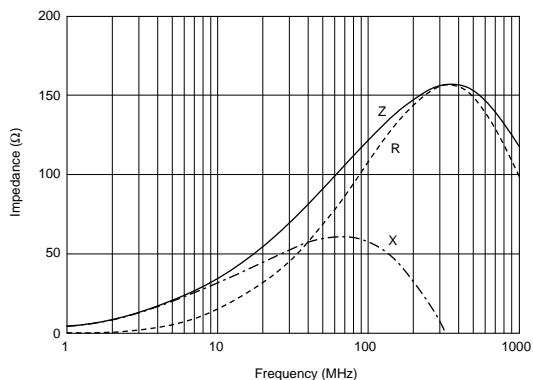

BLM21AG151SN1

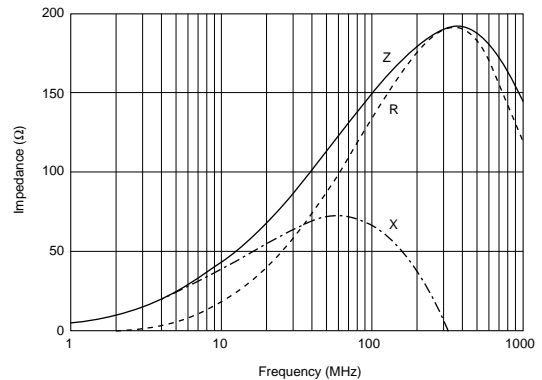

Continued on the following page. ↗

Continued from the preceding page.

### Impedance-Frequency Characteristics

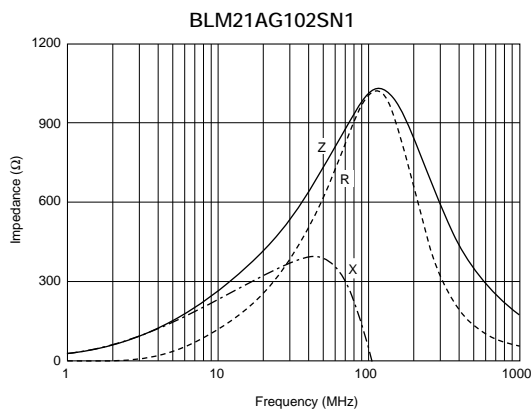
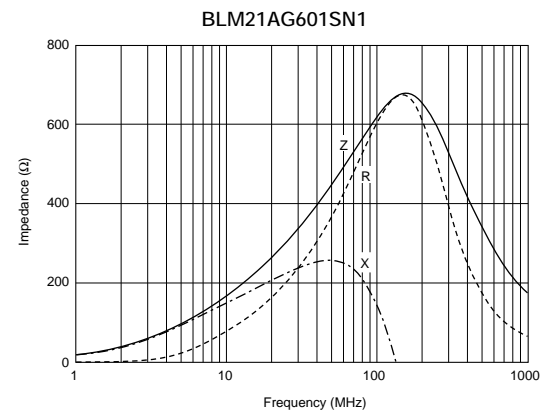
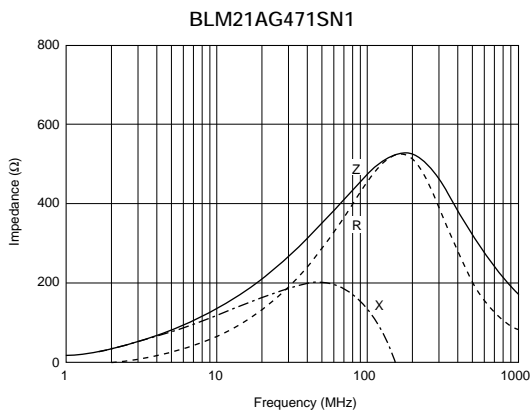
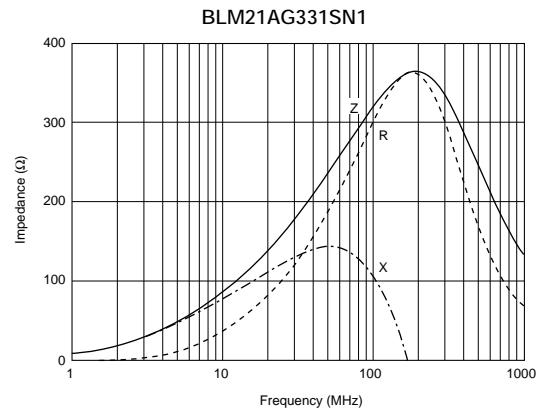
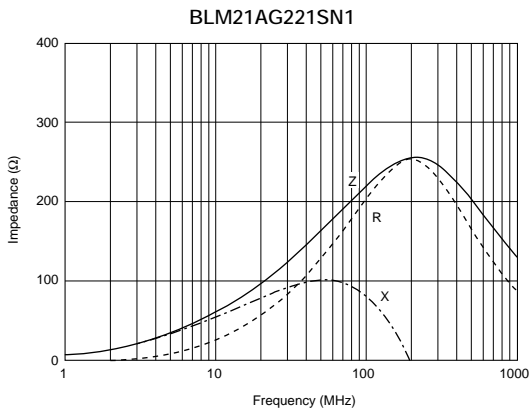

1

## Chip EMI Suppression Filter Design Kits



### ●EKEMBL15C (Chip Ferrite Beads 0402 Size)

No.	Part Number	Quantity (pcs.)	Impedance typ. (at 100MHz, 20 degree C)	Rated Current (mA)	DC Resistance (Ω) max.
1	BLM15AG100SN1	20	10Ω (Typ.)	1000	0.05
2	BLM15AG700SN1	20	70Ω (Typ.)	500	0.15
3	BLM15AG121SN1	20	120Ω±25%	500	0.25
4	BLM15AG221SN1	20	220Ω±25%	300	0.35
5	BLM15AG601SN1	20	600Ω±25%	300	0.60
6	BLM15AG102SN1	20	1000Ω±25%	200	1.00
7	BLM15BB050SN1	20	5Ω±25%	500	0.08
8	BLM15BB100SN1	20	10Ω±25%	300	0.10
9	BLM15BB220SN1	20	22Ω±25%	300	0.20
10	BLM15BB470SN1	20	47Ω±25%	300	0.35
11	BLM15BB750SN1	20	75Ω±25%	300	0.40
12	BLM15BB121SN1	20	120Ω±25%	300	0.55
13	BLM15BB221SN1	20	220Ω±25%	200	0.80
14	BLM15BD471SN1	20	470Ω±25%	200	0.60
15	BLM15BD601SN1	20	600Ω±25%	200	0.65
16	BLM15BD102SN1	20	1000Ω±25%	200	0.90

### ●EKEMBL18A (Chip Ferrite Beads 0603 Size/ for Large-current P Type)

No.	Part Number	Quantity (pcs.)	Impedance typ. (at 100MHz, 20 degree C)	Rated Current (mA)	DC Resistance (Ω) max.
1	BLM18AG121SN1	20	120Ω±25%	200	0.20
2	BLM18AG221SN1	20	220Ω±25%	200	0.30
3	BLM18AG471SN1	20	470Ω±25%	200	0.50
4	BLM18AG601SN1	20	600Ω±25%	200	0.50
5	BLM18AG102SN1	20	1000Ω±25%	100	0.70
6	BLM18BA050SN1	20	5Ω±25%	500	0.20
7	BLM18BA100SN1	20	10Ω±25%	500	0.25
8	BLM18BA220SN1	20	22Ω±25%	500	0.35
9	BLM18BA470SN1	20	47Ω±25%	300	0.55
10	BLM18BA750SN1	20	75Ω±25%	300	0.70
11	BLM18BA121SN1	20	120Ω±25%	200	0.90
12	BLM18BB100SN1	20	10Ω±25%	500	0.15
13	BLM18BB220SN1	20	22Ω±25%	500	0.25
14	BLM18BB470SN1	20	47Ω±25%	500	0.30
15	BLM18BB600SN1	20	60Ω±25%	200	0.35
16	BLM18BB121SN1	20	120Ω±25%	200	0.50
17	BLM18BB221SN1	20	220Ω±25%	200	0.65
18	BLM18BB471SN1	20	470Ω±25%	50	1.00
19	BLM18BD121SN1	20	120Ω±25%	200	0.40

Continued on the following page.

## Chip EMI Suppression Filter Design Kits

↳ Continued from the preceding page.

No.	Part Number	Quantity (pcs.)	Impedance typ. (at 100MHz, 20 degree C)	Rated Current (mA)	DC Resistance (Ω) max.
20	BLM18BD221SN1	20	220Ω±25%	200	0.45
21	BLM18BD471SN1	20	470Ω±25%	200	0.55
22	BLM18BD601SN1	20	600Ω±25%	200	0.65
23	BLM18BD102SN1	20	1000Ω±25%	100	0.85
24	BLM18BD182SN1	20	1800Ω±25%	50	1.50
25	BLM18BD252SN1	20	2500Ω±25%	50	1.50
26	BLM18HG471SN1	20	470Ω±25%	200	0.85
27	BLM18HG601SN1	20	600Ω±25%	200	1.00
28	BLM18HG102SN1	20	1000Ω±25%	100	1.60
29	BLM18HD471SN1	20	470Ω±25%	100	1.20
30	BLM18HD601SN1	20	600Ω±25%	100	1.50
31	BLM18HD102SN1	20	1000Ω±25%	50	1.80
32	BLM18PG330SN1	20	33Ω±25%	3000	0.025
33	BLM18PG121SN1	20	120Ω±25%	2000	0.05
34	BLM18PG181SN1	20	180Ω±25%	1500	0.09
35	BLM21PG221SN1	20	220Ω (Typ.)	2000	0.05
36	BLM21PG331SN1	20	330Ω (Typ.)	1500	0.09
37	BLM31PG121SN1	20	120Ω (Typ.)	3000	0.025
38	BLM31PG391SN1	20	390Ω (Typ.)	2000	0.05
39	BLM31PG601SN1	20	600Ω (Typ.)	1500	0.09
40	BLM41PG181SN1	20	180Ω (Typ.)	3000	0.025
41	BLM41PG471SN1	20	470Ω (Typ.)	2000	0.05
42	BLM41PG102SN1	20	1000Ω (Typ.)	1500	0.09
43	BLM18RK121SN1	20	120Ω±25%	200	0.25
44	BLM18RK221SN1	20	220Ω±25%	200	0.3
45	BLM18RK471SN1	20	470Ω±25%	200	0.5
46	BLM18RK601SN1	20	600Ω±25%	200	0.6
47	BLM18RK102SN1	20	1000Ω±25%	200	0.8
48	BLM18HK471SN1	20	470Ω±25%	200	0.7
49	BLM18HK601SN1	20	600Ω±25%	100	0.9
50	BLM18HK102SN1	20	1000Ω±25%	50	1.5

### ●EKEMBL21B (Chip Ferrite Beads 0805 Size)

No.	Part Number	Quantity (pcs.)	Impedance typ. (at 100MHz, 20 degree C)	Rated Current (mA)	DC Resistance (Ω) max.
1	BLM21AG121SN1	20	120Ω±25%	200	0.15
2	BLM21AG221SN1	20	220Ω±25%	200	0.20
3	BLM21AG471SN1	20	470Ω±25%	200	0.25
4	BLM21AG601SN1	20	600Ω±25%	200	0.30
5	BLM21AG102SN1	20	1000Ω±25%	200	0.45
6	BLM21BB600SN1	20	60Ω±25%	200	0.20
7	BLM21BB750SN1	20	75Ω±25%	200	0.25
8	BLM21BB121SN1	20	120Ω±25%	200	0.25
9	BLM21BB221SN1	20	220Ω±25%	200	0.35
10	BLM21BB471SN1	20	470Ω±25%	200	0.45
11	BLM21BD121SN1	20	120Ω±25%	200	0.25
12	BLM21BD221SN1	20	220Ω±25%	200	0.25
13	BLM21BD471SN1	20	470Ω±25%	200	0.35
14	BLM21BD601SN1	20	600Ω±25%	200	0.35
15	BLM21BD102SN1	20	1000Ω±25%	200	0.40
16	BLM21BD182SN1	20	1800Ω±25%	200	0.50
17	BLM21BD222SN1	20	2250Ω (Typ.)	200	0.60

Continued on the following page. ↗

## Chip EMI Suppression Filter Design Kits

Continued from the preceding page.

No.	Part Number	Quantity (pcs.)	Impedance typ. (at 100MHz, 20 degree C)	Rated Current (mA)	DC Resistance (Ω) max.
18	<b>BLM21BD222TN1</b>	20	2200Ω±25%	200	0.60
19	<b>BLM21BD272SN1</b>	20	2700Ω±25%	200	0.80

### ●EKEMFL18B (Chip EMIFIL LC Combined Type)

No.	Part Number	Quantity (pcs.)	Cut off Frequency	Rated Voltage	Rated Current	Insulation Resistance (MΩ min.)	DC Resistance max.
1	<b>NFL18ST107X1C3</b>	20	100MHz	16 V	100mA	1000	4.5Ω
2	<b>NFL18ST157X1C3</b>	20	150MHz	16 V	100mA	1000	4.0Ω
3	<b>NFL18ST207X1C3</b>	20	200MHz	16 V	150mA	1000	3.5Ω
4	<b>NFL18ST307X1C3</b>	20	300MHz	16 V	200mA	1000	1.8Ω
5	<b>NFL18ST507X1C3</b>	20	500MHz	16 V	200mA	1000	1.5Ω
6	<b>NFL18SP157X1A3</b>	20	150MHz	10 V	100mA	1000	3.0Ω
7	<b>NFL18SP207X1A3</b>	20	200MHz	10 V	100mA	1000	3.0Ω
8	<b>NFL18SP307X1A3</b>	20	300MHz	10 V	100mA	1000	3.0Ω
9	<b>NFL18SP507X1A3</b>	20	500MHz	10 V	100mA	1000	2.0Ω
10	<b>NFL21SP206X1C3</b>	20	20MHz	16 V	100mA	1000	8.5Ω
11	<b>NFL21SP506X1C3</b>	20	50MHz	16 V	150mA	1000	3.5Ω
12	<b>NFL21SP706X1C3</b>	20	70MHz	16 V	150mA	1000	3.0Ω
13	<b>NFL21SP107X1C3</b>	20	100MHz	16 V	200mA	1000	2.0Ω
14	<b>NFL21SP157X1C3</b>	20	150MHz	16 V	200mA	1000	2.0Ω
15	<b>NFL21SP207X1C3</b>	20	200MHz	16 V	250mA	1000	1.5Ω
16	<b>NFL21SP307X1C3</b>	20	300MHz	16 V	300mA	1000	1.2Ω
17	<b>NFL21SP407X1C3</b>	20	400MHz	16 V	300mA	1000	1.2Ω
18	<b>NFL21SP507X1C3</b>	20	500MHz	16 V	300mA	1000	1.2Ω

No.	Part Number	Quantity (pcs.)	Cut off Frequency	Attenuation (dB min.)										Rated Current	Rated Voltage
				10MHz	20MHz	50MHz	100MHz	150MHz	200MHz	300MHz	400MHz	500MHz	1GHz		
19	<b>NFW31SP106X1E4</b>	20	10MHz	6dB max	5	25	25	-	25	-	-	30	30	200mA	25V
20	<b>NFW31SP206X1E4</b>	20	20MHz	-	6dB max	5	25	-	25	-	-	30	30	200mA	25V
21	<b>NFW31SP506X1E4</b>	20	50MHz	-	-	6dB max	10	-	30	-	-	30	30	200mA	25V
22	<b>NFW31SP107X1E4</b>	20	100MHz	-	-	-	6dB max	-	5	-	-	20	30	200mA	25V
23	<b>NFW31SP157X1E4</b>	20	150MHz	-	-	-	-	6dB max	-	10	20	30	30	200mA	25V
24	<b>NFW31SP207X1E4</b>	20	200MHz	-	-	-	-	-	6dB max	-	-	10	30	200mA	25V
25	<b>NFW31SP307X1E4</b>	20	300MHz	-	-	-	-	-	-	6dB max	-	5	15	200mA	25V
26	<b>NFW31SP407X1E4</b>	20	400MHz	-	-	-	-	-	-	-	6dB max	-	10	200mA	25V
27	<b>NFW31SP507X1E4</b>	20	500MHz	-	-	-	-	-	-	-	-	6dB max	10	200mA	25V

### ●EKEMFA31B (Chip EMIFIL Capacitor Array Type/ Capacitor Type/ LC Combined Type)

No.	Part Number	Quantity (pcs.)	Capacitance	Rated Voltage	Rated Current	Insulation Resistance (MΩ min.)
1	<b>NFA31CC220S1E4</b>	20	22pF±20%	25 V	200mA	1000
2	<b>NFA31CC470S1E4</b>	20	47pF±20%	25 V	200mA	1000
3	<b>NFA31CC101S1E4</b>	20	100pF±20%	25 V	200mA	1000
4	<b>NFA31CC221S1E4</b>	20	220pF±20%	25 V	200mA	1000
5	<b>NFA31CC471R1E4</b>	20	470pF±20%	25 V	200mA	1000
6	<b>NFA31CC102R1E4</b>	20	1000pF±20%	25 V	200mA	1000
7	<b>NFA31CC222R1E4</b>	20	2200pF±20%	25 V	200mA	1000
8	<b>NFA31CC223R1C4</b>	20	22000pF±20%	16 V	200mA	1000
9	<b>NFA31GD1006R84</b>	20	10pF±20%	6 V	50mA	1000
10	<b>NFA31GD1004704</b>	20	10pF±20%	6 V	20mA	1000
11	<b>NFA31GD1001014</b>	20	10pF±20%	6 V	15mA	1000
12	<b>NFA31GD4706R84</b>	20	47pF±20%	6 V	50mA	1000

Continued on the following page. 



## Chip EMI Suppression Filter Design Kits

↳ Continued from the preceding page.

### ●EKEMFA31B (Chip EMIFIL Capacitor Array Type/ Capacitor Type/ LC Combined Type)

No.	Part Number	Quantity (pcs.)	Capacitance	Rated Voltage	Rated Current	Insulation Resistance (MΩ min.)
13	<b>NFA31GD4704704</b>	20	47pF±20%	6 V	20mA	1000
14	<b>NFA31GD4701014</b>	20	47pF±20%	6 V	15mA	1000
15	<b>NFA31GD1016R84</b>	20	100pF±20%	6 V	50mA	1000
16	<b>NFA31GD1014704</b>	20	100pF±20%	6 V	20mA	1000
17	<b>NFA31GD1011014</b>	20	100pF±20%	6 V	15mA	1000

### ●EKEMDL21D (Chip Common Mode Choke Coils)

No.	Part Number	Quantity (pcs.)	Common Mode Impedance typ. (at 100MHz, 20 degree C)	Rated Voltage	Rated Current	Insulation Resistance (MΩ min.)
1	<b>DLW21HN670SQ2</b>	10	67Ω (Typ.)	50V	330mA	10
2	<b>DLW21HN900SQ2</b>	10	90Ω (Typ.)	50V	330mA	10
3	<b>DLW21HN121SQ2</b>	10	120Ω (Typ.)	50V	280mA	10
4	<b>DLW21HN181SQ2</b>	10	180Ω (Typ.)	50V	250mA	10
5	<b>DLW21SN670SQ2</b>	10	67Ω (Typ.)	50V	400mA	10
6	<b>DLW21SN900SQ2</b>	10	90Ω (Typ.)	50V	330mA	10
7	<b>DLW21SN121SQ2</b>	10	120Ω (Typ.)	50V	370mA	10
8	<b>DLW21SN181SQ2</b>	10	180Ω (Typ.)	50V	330mA	10
9	<b>DLW21SN261SQ2</b>	10	260Ω (Typ.)	50V	300mA	10
10	<b>DLW21SN371SQ2</b>	10	370Ω (Typ.)	50V	280mA	10
11	<b>DLW31SN900SQ2</b>	10	90Ω (Typ.)	50V	370mA	10
12	<b>DLW31SN161SQ2</b>	10	160Ω (Typ.)	50V	340mA	10
13	<b>DLW31SN261SQ2</b>	10	260Ω (Typ.)	50V	310mA	10
14	<b>DLW31SN601SQ2</b>	10	600Ω (Typ.)	50V	260mA	10
15	<b>DLW31SN102SQ2</b>	10	1000Ω (Typ.)	50V	230mA	10
16	<b>DLW31SN222SQ2</b>	10	2200Ω (Typ.)	50V	200mA	10
17	<b>DLW5AHN402SQ2</b>	5	4000Ω (Typ.)	50V	200mA	10
18	<b>DLW5BSN302SQ2</b>	5	3000Ω (Typ.)	50V	500mA	10
19	<b>DLW5BSN152SQ2</b>	5	1500Ω (Typ.)	50V	1000mA	10
20	<b>DLW5BSN102SQ2</b>	5	1000Ω (Typ.)	50V	1500mA	10
21	<b>DLW5BSN351SQ2</b>	5	350Ω (Typ.)	50V	2000mA	10
22	<b>DLW5BSN191SQ2</b>	5	190Ω (Typ.)	50V	5000mA	10
23	<b>DLP11SN900SL2</b>	10	90Ω (Typ.)	5V	160mA	100
24	<b>DLP11SN121SL2</b>	10	120Ω (Typ.)	5V	140mA	100
25	<b>DLP11SN161SL2</b>	10	160Ω (Typ.)	5V	120mA	100
26	<b>DLP11SN201SL2</b>	10	200Ω (Typ.)	5V	130mA	100
27	<b>DLP31DN900ML4</b>	10	90Ω±20%	10V	160mA	100
28	<b>DLP31DN131ML4</b>	10	130Ω±20%	10V	120mA	100
29	<b>DLP31DN201ML4</b>	10	200Ω±20%	10V	100mA	100
30	<b>DLP31DN321ML4</b>	10	320Ω±20%	10V	80mA	100
31	<b>DLP31DN441ML4</b>	10	440Ω±20%	10V	70mA	100

### ●EKEMNFMPB

No.	Part Number	Quantity (pcs.)	Capacitance	Rated Voltage	Rated Current	Insulation Resistance (MΩ min.)
1	<b>NFM18PC104R1C3</b>	20	0.1μF±20%	16 V	2A	1000
2	<b>NFM18PC105R0J3</b>	20	1μF±20%	6.3 V	2A	500
3	<b>NFM21PC104R1E3</b>	20	0.1μF±20%	25 V	2A	1000
4	<b>NFM21PC224R1C3</b>	20	0.22μF±20%	16 V	2A	1000
5	<b>NFM21PC474R1C3</b>	20	0.47μF±20%	16 V	2A	1000
6	<b>NFM21PC105B1A3</b>	20	1μF±20%	10 V	4A	500

Continued on the following page. ↗

## Chip EMI Suppression Filter Design Kits

Continued from the preceding page.

No.	Part Number	Quantity (pcs.)	Capacitance	Rated Voltage	Rated Current	Insulation Resistance (MΩ min.)
7	<b>NFM21PC105B1C3</b>	20	1μF±20%	16 V	4A	500
8	<b>NFE31PT152Z1E9</b>	20	1500pF +50/-20%	25 V	6A	1000
9	<b>NFE31PT222Z1E9</b>	20	2200pF±50%	25 V	6A	1000
10	<b>NFE61PT102E1H9</b>	20	1000pF +80/-20%	50 V	2A	1000
11	<b>NFE61PT472C1H9</b>	20	4700pF +80/-20%	50 V	2A	1000
12	<b>NFM41PC204F1H3</b>	20	0.2μF +80/-20%	50 V	2A	1000
13	<b>NFM41PC155B1E3</b>	20	1.5μF±20%	25 V	6A	300

### ●EKEMNFMCA

No.	Part Number	Quantity (pcs.)	Capacitance	Rated Voltage	Rated Current	Insulation Resistance (MΩ min.)
1	<b>NFM18CC220U1C3</b>	20	22pF±20%	16 V	400mA	1000
2	<b>NFM18CC470U1C3</b>	20	47pF±20%	16 V	400mA	1000
3	<b>NFM18CC101R1C3</b>	20	100pF±20%	16 V	500mA	1000
4	<b>NFM18CC221R1C3</b>	20	220pF±20%	16 V	500mA	1000
5	<b>NFM18CC471R1C3</b>	20	470pF±20%	16 V	500mA	1000
6	<b>NFM18CC102R1C3</b>	20	1000pF±20%	16 V	600mA	1000
7	<b>NFM18CC222R1C3</b>	20	2200pF±20%	16 V	700mA	1000
8	<b>NFM18CC223R1C3</b>	20	22000pF±20%	16 V	1000mA	1000
9	<b>NFM21CC220U1H3</b>	20	22pF±20%	50 V	700mA	1000
10	<b>NFM21CC470U1H3</b>	20	47pF±20%	50 V	700mA	1000
11	<b>NFM21CC101U1H3</b>	20	100pF±20%	50 V	700mA	1000
12	<b>NFM21CC221R1H3</b>	20	220pF±20%	50 V	700mA	1000
13	<b>NFM21CC471R1H3</b>	20	470pF±20%	50 V	1000mA	1000
14	<b>NFM21CC102R1H3</b>	20	1000pF±20%	50 V	1000mA	1000
15	<b>NFM21CC222R1H3</b>	20	2200pF±20%	50 V	1000mA	1000
16	<b>NFM21CC223R1H3</b>	20	22000pF±20%	50 V	2000mA	1000

Copyright © Each Manufacturing Company.

All Datasheets cannot be modified without permission.

This datasheet has been download from :

[www.AllDataSheet.com](http://www.AllDataSheet.com)

100% Free DataSheet Search Site.

Free Download.

No Register.

Fast Search System.

[www.AllDataSheet.com](http://www.AllDataSheet.com)