



## Features

- Lead free versions available
- RoHS compliant (lead free version)\*
- SMC package
- Surface mount
- High current capability

## CD214C-B320 ~ B360 Schottky Barrier Rectifier Chip Diode

### General Information

The markets of portable communications, computing and video equipment are challenging the semiconductor industry to develop increasingly smaller electronic components.

Bourns offers Schottky Rectifier Diodes for rectification applications, in compact chip package DO-214AB (SMC) size format, which offer PCB real estate savings and are considerably smaller than competitive parts. The Schottky Rectifier Diodes offer a forward current of 3 A with a choice of repetitive peak reverse voltage of 20 V up to 60 V.

Bourns® Chip Diodes conform to JEDEC standards, are easy to handle with standard pick and place equipment and the flat configuration minimizes roll away.

### Electrical Characteristics (@ T<sub>A</sub> = 25 °C Unless Otherwise Noted)

Parameter	Symbol	CD214C-					Unit
		B320	B330	B340	B350	B360	
Forward Voltage (Max.) (I <sub>f</sub> = 3 A)	V <sub>F</sub>	0.5	0.5	0.5	0.7	0.7	V
Typical Junction Capacitance*	C <sub>T</sub>	250					pF
Reverse Current (Max.) at Rated V <sub>R</sub> )	I <sub>R</sub>	0.5					mA

\* Measured at 1.0 MHz and applied reverse voltage of 4.0 V DC.

### Absolute Ratings (@ T<sub>A</sub> = 25 °C Unless Otherwise Noted)

Parameter	Symbol	CD214C-					Unit
		B320	B330	B340	B350	B360	
Repetitive Peak Reverse Voltage	V <sub>RRM</sub>	20	30	40	50	60	V
Reverse Voltage	V <sub>R</sub>	20	30	40	50	60	V
Maximum RMS Voltage	V <sub>RMS</sub>	14	21	28	35	42	V
Avg. Forward Current	I <sub>O</sub>	3					A
Forward Current, Surge Peak (60 Hz, 1 cycle)	I <sub>surge</sub>	100					A
Typical Thermal Resistance**	R <sub>θJL</sub>	10					°C/W
Storage Temperature	T <sub>STG</sub>	-55 to +150					°C
Junction Temperature	T <sub>J</sub>	-55 to +125					°C

\*\* Thermal resistance junction to lead.



Reliable Electronic Solutions

#### Asia-Pacific:

Tel: +886-2 2562-4117 • Fax: +886-2 2562-4116

#### Europe:

Tel: +41-41 768 5555 • Fax: +41-41 768 5510

#### The Americas:

Tel: +1-951 781-5500 • Fax: +1-951 781-5700

[www.bourns.com](http://www.bourns.com)

\*RoHS Directive 2002/95/EC Jan 27 2003 including Annex  
Specifications are subject to change without notice.  
Customers should verify actual device performance in their specific applications.

### How To Order

**CD 214C - B 3 30**

Common Code \_\_\_\_\_  
Chip Diode

Package \_\_\_\_\_  
• 214C = SMC/DO-214AB

Model \_\_\_\_\_  
B = Schottky Barrier Series

Average Forward Current (I<sub>O</sub>) Code \_\_\_\_\_  
3 = 3 A (Code x 1000 mA = Average Forward Current)

Reverse Voltage (V<sub>R</sub>) Code \_\_\_\_\_  
30 = 30 V  
40 = 40 V  
60 = 60 V

Terminations \_\_\_\_\_  
LF = 100 % Sn (lead free)  
Blank = Sn/Pb

# CD214C-B320 ~ B360 Schottky Barrier Rectifier Chip Diode



## Product Dimensions

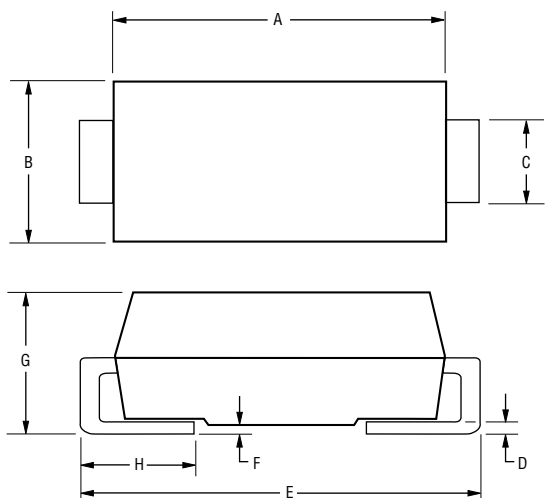

Dimension	SMC (DO-214AB)
A	$\frac{6.60 - 7.11}{(0.260 - 0.280)}$
B	$\frac{5.59 - 6.22}{(0.220 - 0.245)}$
C	$\frac{2.92 - 3.18}{(0.115 - 0.125)}$
D	$\frac{0.15 - 0.31}{(0.006 - 0.112)}$
E	$\frac{7.75 - 8.13}{(0.305 - 0.320)}$
F	$\frac{0.05 - 0.20}{(0.002 - 0.008)}$
G	$\frac{2.01 - 2.62}{(0.080 - 0.103)}$
H	$\frac{0.76 - 1.52}{(0.030 - 0.060)}$

DIMENSIONS:  $\frac{\text{MM}}{\text{(INCHES)}}$

## Recommended Pad Layout

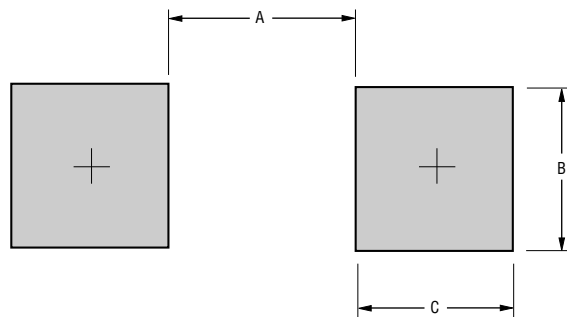

Dimension	SMC (DO-214AB)
A (Max.)	$\frac{2.69}{(0.106)}$
B (Min.)	$\frac{2.10}{(0.083)}$
C (Min.)	$\frac{1.27}{(0.050)}$

DIMENSIONS:  $\frac{\text{MM}}{\text{(INCHES)}}$

## Physical Specifications

Case .....Molded plastic  
 Polarity .....Indicated by cathode band  
 Weight .....0.007 ounces / 0.21 grams

## Typical Part Marking

CD214C-B320 ..... **B** 320B  
 CD214C-B330 ..... **B** 330B  
 CD214C-B340 ..... **B** 340B  
 CD214C-B350 ..... **B** 350B  
 CD214C-B360 ..... **B** 360B

# CD214C-B320 ~ B360 Schottky Barrier Rectifier Chip Diode



## Rating and Characteristic Curves

### Forward Current Derating Curve

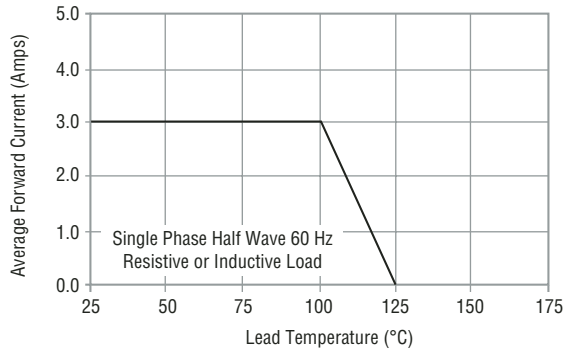

### Maximum Non-Repetitive Surge Current

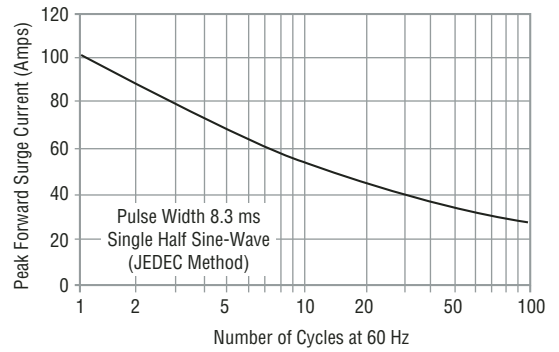

### Typical Forward Characteristics

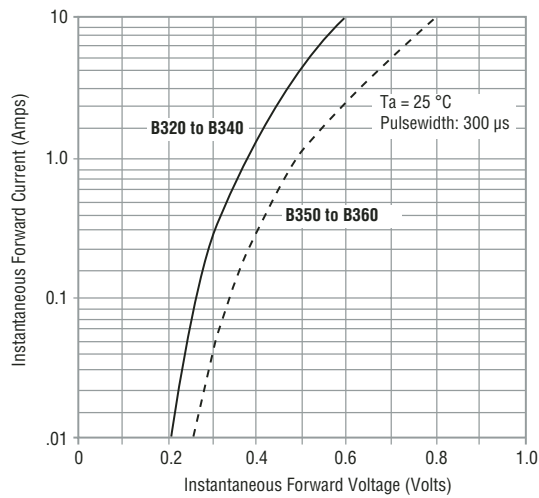

### Typical Junction Capacitance

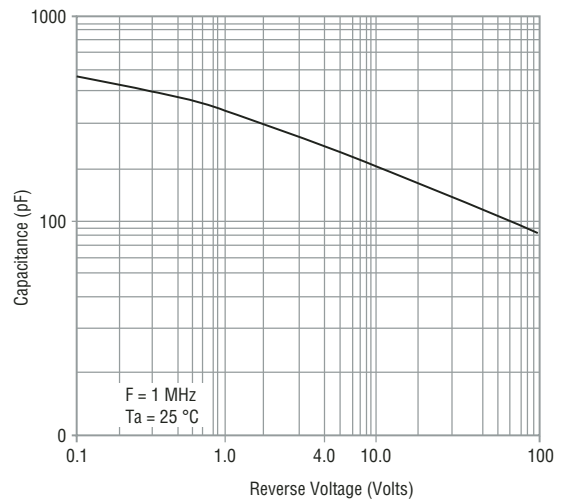

### Typical Reverse Characteristics

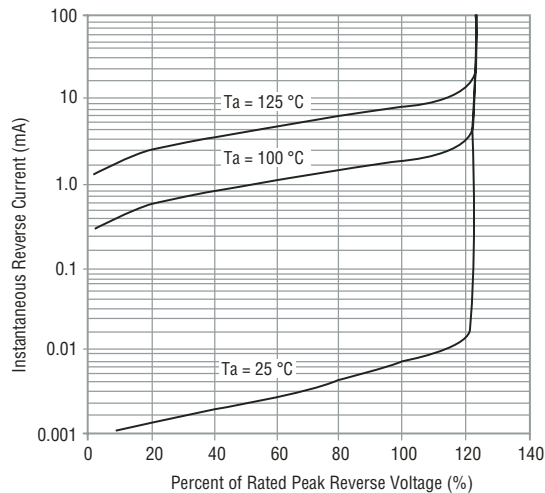

Specifications are subject to change without notice.  
Customers should verify actual device performance in their specific applications.

# CD214C-B320 ~ B360 Schottky Barrier Rectifier Chip Diode

**BOURNS®**

## Packaging Information

The product will be dispensed in Tape and Reel format (see diagram below).

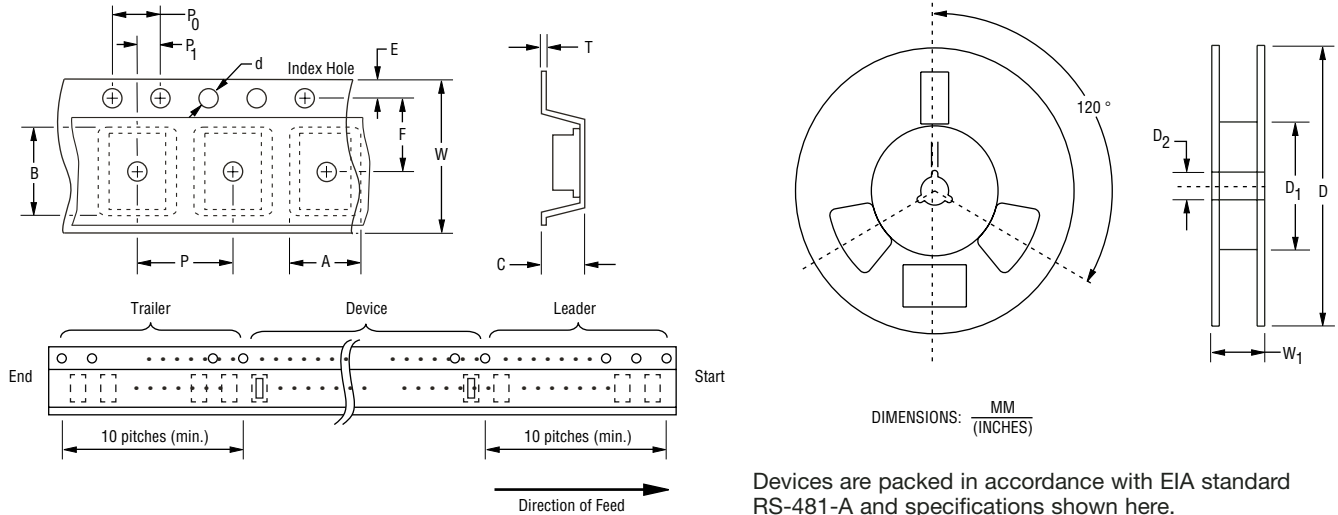

Devices are packed in accordance with EIA standard RS-481-A and specifications shown here.

Item	Symbol	SMC (DO-214AB)
Carrier Width	A	$\frac{7.22 \pm 0.10}{(0.284 - 0.004)}$
Carrier Length	B	$\frac{8.11 \pm 0.10}{(0.319 - 0.004)}$
Carrier Depth	C	$\frac{2.36 \pm 0.10}{(0.093 - 0.004)}$
Sprocket Hole	d	$\frac{1.55 \pm 0.05}{(0.061 - 0.002)}$
Reel Outside Diameter	D	$\frac{330}{(12.992)}$
Reel Inner Diameter	D <sub>1</sub>	$\frac{50.0}{(1.969)}$ MIN.
Feed Hole Diameter	D <sub>2</sub>	$\frac{13.0 \pm 0.20}{(0.512 - 0.008)}$
Sprocket Hole Position	E	$\frac{1.75 \pm 0.10}{(0.069 - 0.004)}$
Punch Hole Position	F	$\frac{7.50 \pm 0.10}{(0.295 - 0.004)}$
Punch Hole Pitch	P	$\frac{4.00 \pm 0.10}{(0.157 - 0.004)}$
Sprocket Hole Pitch	P <sub>0</sub>	$\frac{4.00 \pm 0.10}{(0.157 - 0.004)}$
Embossment Center	P <sub>1</sub>	$\frac{2.00 \pm 0.10}{(0.079 - 0.004)}$
Overall Tape Thickness	T	$\frac{0.30 \pm 0.10}{(0.012 - 0.004)}$
Tape Width	W	$\frac{16.00 \pm 0.20}{(0.630 - 0.008)}$
Reel Width	W <sub>1</sub>	$\frac{22.4}{(0.882)}$ MAX.
Quantity per Reel	--	3,000