

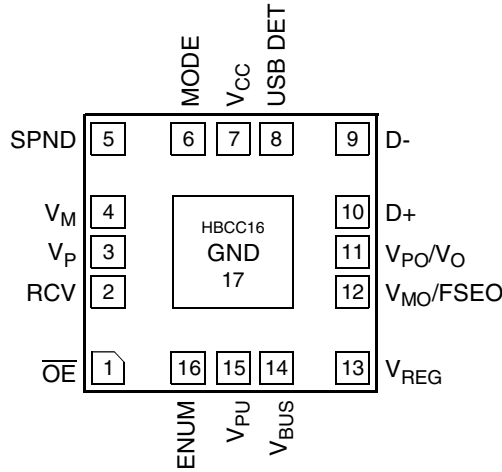

PACKAGE / PINOUT DIAGRAM



**HBCC16 Package
Bottom View**

Note: This drawing is not to scale.

PIN DESCRIPTIONS

PINS	NAME	DESCRIPTION
1	\overline{OE}	Input for Output Enable (Active low). Enables transceiver driver to transmit data on the USB bus. When \overline{OE} pin = LOW, driver circuitry is enabled.
2	RCV	Differential receiver output of D+ and D- input data lines. The output state of RCV is preserved and stable during an SE0 condition.
3	V_P	Single-ended D+ receiver output for detection of a single-ended zero or error conditions
4	V_M	Single-ended D- receiver output for detection of a single-ended zero or error conditions.
5	SPND	Suspend input. Allows the device to enter a low power state while the USB is inactive.
6	MODE	Mode input. Selects between differential (V_{PO} , V_{MO}) and single-ended mode (V_O , FSEO).
7	V_{CC}	Supply voltage for digital I/O pins. Voltages supported: 1.65 to 3.3V.
8	USB_DET	I/O level USB detect output. Logic High indicates that a USB cable is present.
9	D-	Negative USB data connection.
10	D+	Positive USB data connection. In full-speed connect mode, connect to V_{PU} via a 1.5k Ω resistor. Tolerance of this resistor is defined in the USB specification REV 1.1 & 2.0
11	V_{PO}/V_O	Driver data input.
12	$V_{MO}/FSEO$	Driver data input.
13	V_{REG}	Regulated supply voltage output during USB operation of V_{BUS} . 1uF decoupling capacitor is required.
14	V_{BUS}	Supply voltage input. Can be directly connected to USB V_{BUS} .
15	V_{PU}	Pull-up supply voltage. Pin function is controlled by input ENUM.

PIN DESCRIPTIONS

16	ENUM	Enumerate, allows software to control connection of the external pull-up via the level translator. If ENUM = LOW then V_{PU} is floating. If ENUM = HIGH then V_{PU} is internally connected to V_{REG} .
17	GND	The ground terminal is connected to the exposed diepad (heatsink).

Ordering Information
PART NUMBERING INFORMATION

PADS	Package	Ordering Part Number ¹	Part Marking
16	HBCC16	CM2400-01HB	CMD240001A

Note 1: Parts are shipped in Tape & Reel form unless otherwise specified.

Specifications
ABSOLUTE MAXIMUM RATINGS

PARAMETER	RATING	UNITS
ESD Protection (HBM, All Pins, See Note 1)	± 2000	V
V_{BUS}	[GND - 0.5] to +5.5	V
V_{CC}	[GND - 0.5] to +6.0	V
V_I (INPUT)	[GND - 0.5] to [$V_{CC} + 0.5$]	V
Storage Temperature Range	-65 to +150	°C
Operating Temperature Range Junction	-40 to +150	°C

Note 1: Equivalent to discharging a 100pF capacitor via a 1.5k Ω resistor (Human body model).

STANDARD (RECOMMENDED) OPERATING CONDITIONS

SYMBOL	PARAMETER	MIN	TYP	MAX	UNITS
V_{BUS}	USB V_{BUS} Supply	4.1	5.0	5.5	V
V_{CC}	DC System Supply	1.65	3.3	3.6	V
V_I	DC Input Voltage	0	-	V_{CC}	V
$V_{I(A/I/O)}$	Analog I/O Pins (D+, D-)	0	-	3.6	V
T_{AMB}	Ambient Operating Temperature Range	-40	-	85	°C

Specifications (cont'd)

ELECTRICAL OPERATING CHARACTERISTICS¹						
Supply Pins ($V_{BUS} = 4.1V$ to $5.5V$; $V_{CC} = 1.65V$ to $3.6V$)						
SYMBOL	PARAMETER	CONDITIONS	MIN	TYP	MAX	UNITS
V_{REG}	Regulated supply output	Unloaded	3.0	3.3	3.6	V
I_{BUS}	Operating supply current	Full-speed TX and RX; $C_L=50pF$ on D+/D- outputs			10	mA
$I_{BUS(IDLE)}$	Supply current during full speed idle and SE0	Full-speed idle; Note 2			500	μA
$I_{BUS(SUSP)}$	Supply current during suspend	SPND = HI; Note 2			100	μA
I_{CC}	Operating I/O supply current	Full-speed TX and RX			2.0	mA
$I_{CC(STAT)}$	Static I/O supply current	Full-speed idle, SE0 or suspend			10.0	μA
$I_{CC(SHARE)}$	Supply current during sharing mode	V_{BUS} not connected			10.0	μA
$I_{DX(SHARE)}$	D+/D- load current during sharing mode	V_{BUS} not connected; ENUMERATE = LOW			10.0	μA
$V_{TH(VBUS)}$	V_{BUS} supply detection threshold, USB_D output	Supply lost (USB_D low)			3.6	V
		Supply present	4.1			V
		$V_{TH(VBUS)}$ Hysteresis		100		mV
$V_{TH(VCC)}$	V_{CC} supply detection threshold.	Supply lost (USB_D low)			0.5	V
		Supply present	1.4			V
		$V_{TH(VCC)}$ Hysteresis		200		mV
Digital Pins ($V_{BUS} = 4.1V$ to $5.5V$; $V_{CC} = 1.8V \pm 0.15V$)						
SYMBOL	PARAMETER	CONDITIONS	MIN	TYP	MAX	UNITS
V_{IL}	Logic LOW input voltage				0.5	V
V_{IH}	Logic HIGH input voltage		1.2			V
V_{OL}	Logic LOW output voltage	$I_{OL} = 100\mu A$			0.15	V
		$I_{OL} = 2mA$			0.40	V
V_{OH}	Logic HIGH output voltage	$I_{OH} = 100\mu A$	1.50			V
		$I_{OH} = 2mA$	1.25			V
Digital Pins ($V_{BUS} = 4.1V$ to $5.5V$; $V_{CC} = 2.5V \pm 0.2V$)						
SYMBOL	PARAMETER	CONDITIONS	MIN	TYP	MAX	UNITS
V_{IL}	Logic LOW input voltage				0.7	V
V_{IH}	Logic HIGH input voltage		1.7			V
V_{OL}	Logic LOW output voltage	$I_{OL} = 100\mu A$			0.15	V
		$I_{OL} = 2mA$			0.40	V
V_{OH}	Logic HIGH output voltage	$I_{OH} = 100\mu A$	2.15			V
		$I_{OH} = 2mA$	1.90			V

Note 1: Operating Characteristics are over Standard Operating Conditions unless otherwise specified.

Note 2: Excluding any load current and V_{PU}/V_{SW} source current to $1.5k\Omega$ and $15k\Omega$ pull-up and pull-down resistors (200 μA).

Specifications (cont'd)

ELECTRICAL OPERATING CHARACTERISTICS (CONT'D)						
Analog I/O Pins ($V_{BUS} = 4.1V$ to $5.5V$; $V_{CC} = 1.65V$ to $3.6V$)						
SYMBOL	PARAMETER	CONDITIONS	MIN	TYP	MAX	UNITS
V_{DI}	Differential receiver input sensitivity	$ V_I(D+) - V_I(D-) $	0.2			V
V_{CM}	Differential receiver common mode voltage		0.8		2.5	V
V_{IL}	Single-ended receiver logic LOW input voltage				0.8	V
V_{IH}	Single-ended receiver logic HIGH input voltage		2.0			V
V_{HYS}	Single-ended receiver Hysteresis voltage		0.4		0.7	V
V_{OL}	Logic LOW output voltage	$R_L = 1.5K\Omega$ tied to +3.6V			0.3	V
V_{OH}	Logic HIGH output voltage	$R_L = 15K\Omega$ tied to GND	2.8		3.6	V
I_{LZ}	OFF-state leakage current				± 1	μA
C_{IN}	Transceiver Capacitance	Pin to GND		10		pF
R_{SW}	Internal switch resistance at V_{PU}			30		Ω
Z_{DRV}	Driver output impedance (includes 33 ohm 1% resistor)	Measured with steady-state drive; See Note 3	33	39	44	Ω
Driver Characteristics & Timings (Full-speed mode only)						
SYMBOL	PARAMETER	CONDITIONS	MIN	TYP	MAX	UNITS
t_{FR}	Rise time	$C_L = 50$ to $125pF$, measured 10% to 90% ($V_{OH}-V_{OL}$); See Figure 6	4		20	ns
t_{FF}	Fall time	$C_L = 50$ to $125pF$, measured 10% to 90% ($V_{OH}-V_{OL}$); See Figure 6	4		20	ns
FRFM	Differential rise / fall time matching (t_{FR}/t_{FF})	Excluding the first transition from idle state	90		110	%
V_{CRS}	Output signal crossover voltage	Excluding the first transition from idle state; See Figure 9	1.3		2.0	V
$t_{PLH}(DRV)$	Driver propagation delay ($V_O/$	LOW-to-HIGH transition; See Figure 9			25	ns
$t_{PHL}(DRV)$	$V_{PO} \rightarrow D+/D-$, FSEO/ $V_{MO} \rightarrow D+/D-$	HIGH-to-LOW transition; See Figure 9			25	ns
t_{PHZ}	Driver disable delay ($\overline{OE} \rightarrow D+/D-$)	HIGH-to-OFF; See Figure 7			25	ns
t_{PLZ}		LOW-to-OFF; See Figure 7			25	ns
t_{PZH}	Driver enable delay ($\overline{OE} \rightarrow D+/D-$)	OFF-to-HIGH; See Figure 7			18	ns
t_{PZL}		OFF-to-LOW; See Figure 7			18	ns

Note 3: Rev 2.0 states Z_{DRV} must be between 28Ω and 44Ω when the driver is not high speed capable.

Specifications (cont'd)

ELECTRICAL OPERATING CHARACTERISTICS (CONT'D)						
Receiver Timings (Full-speed mode only)						
SYMBOL	PARAMETER	CONDITIONS	MIN	TYP	MAX	UNITS
Differential Receiver						
$t_{PLH(RCV)}$	Driver propagation delay (D+/D- → RCV)	LOW-to-HIGH transition; See Figure 8			15	ns
$t_{PHL(RCV)}$		HIGH-to-LOW transition; See Figure 8			15	ns
Single-ended Receiver						
$t_{PLH(SE)}$	Driver propagation delay (D+/D- → V_P, V_M)	LOW-to-HIGH transition; See Figure 8			15	ns
$t_{PHL(SE)}$		HIGH-to-LOW transition; See Figure 8			15	ns

Test Loads

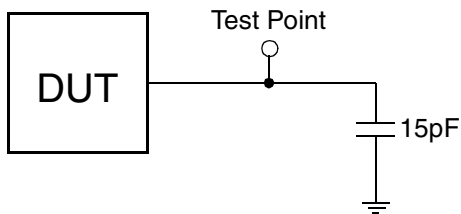

Load for V_P, V_M and RCV delay measurements

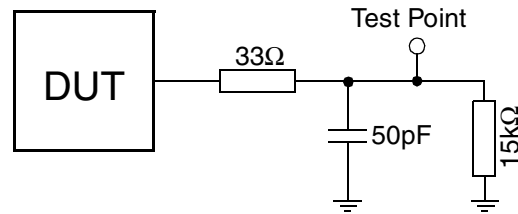

Load for D+ and D- delay measurements (Max and Min Timing)

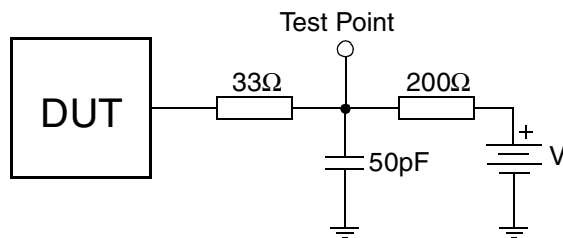

Load for ENABLE and DISABLE delay measurements.

$V = V_{REG}(3.3)$ for tPZL and tPLZ
 $V = 0$ v for tPZH and tPHZ



Performance Information

CM2400-01 Typical DC Characteristics (nominal conditions unless specified otherwise)

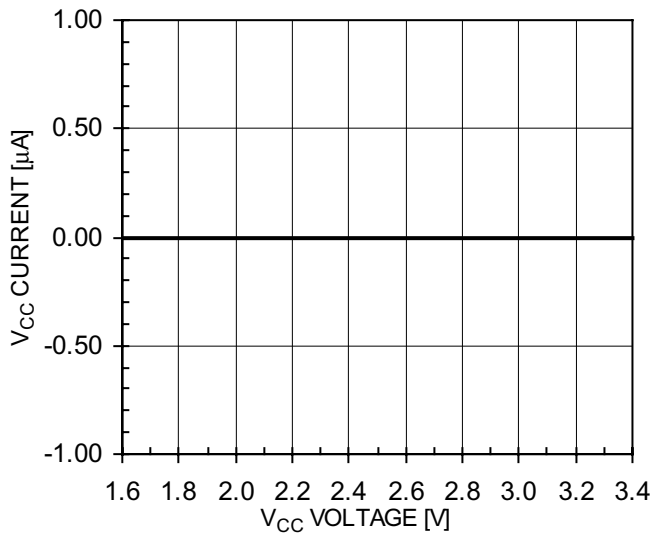

Figure 1. V_{CC} Current in Idle Mode (SPND=LOW)

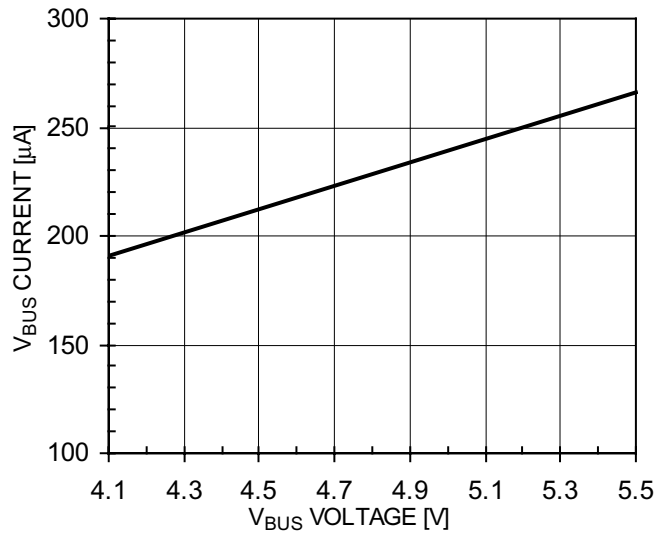

Figure 3. V_{BUS} CURRENT in Idle Mode (SPND=LOW)

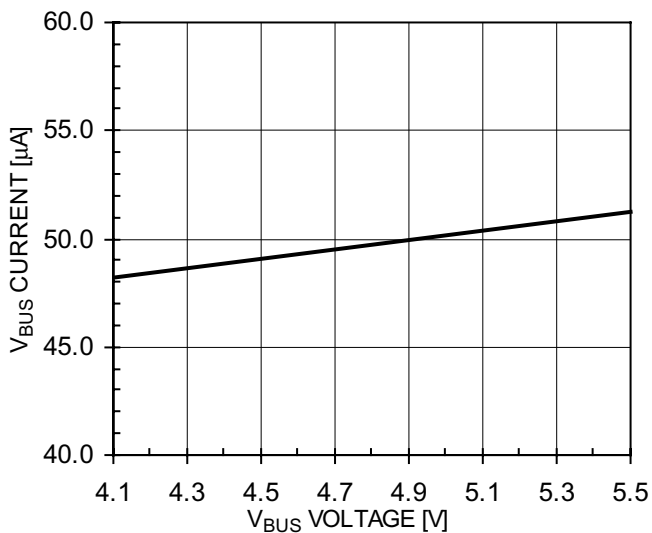

Figure 2. V_{BUS} Current in Suspend Mode (SPND=HIGH)

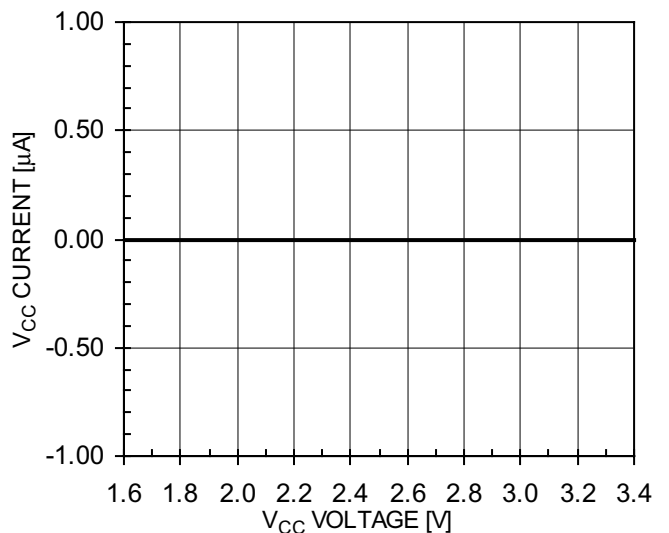

Figure 4. V_{CC} Current in Suspend Mode (SPND=HIGH)



Performance Information (cont'd)

CM2400-01 Typical AC Characteristics (nominal conditions unless specified otherwise)

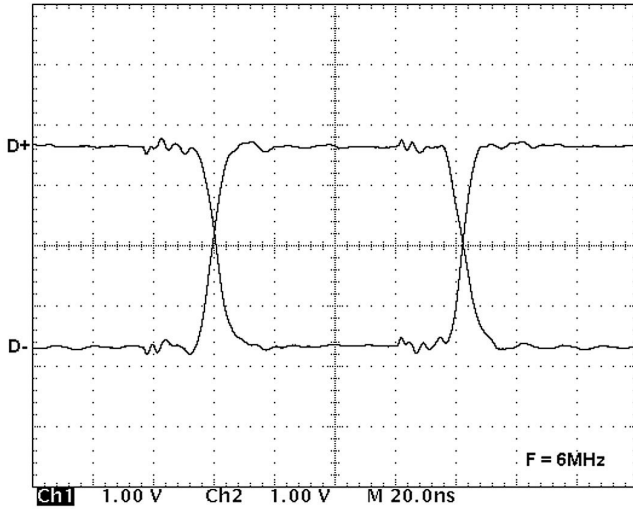

Figure 5. Rise and Fall Time Matching

Performance Information

CM2400 Timing Diagrams

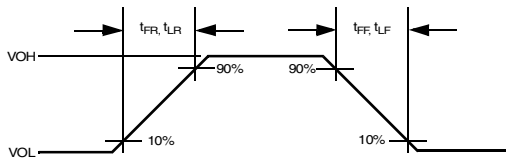

Figure 6. Rise and Fall Timing

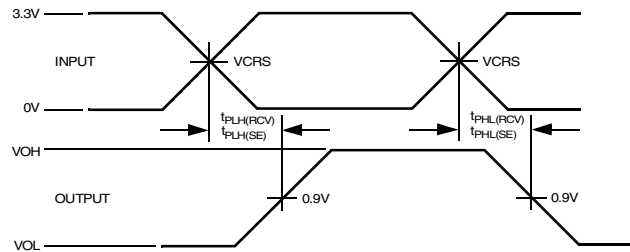

Figure 8. D+, D- to RCV, V_P and V_M Timing

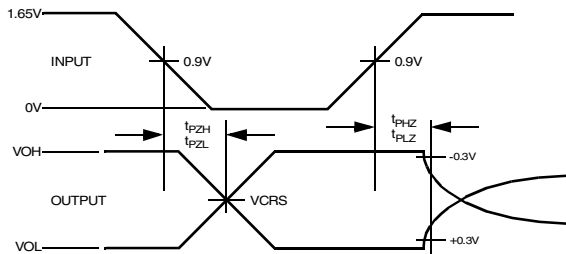

Figure 7. \overline{OE} to D+, D- Timing

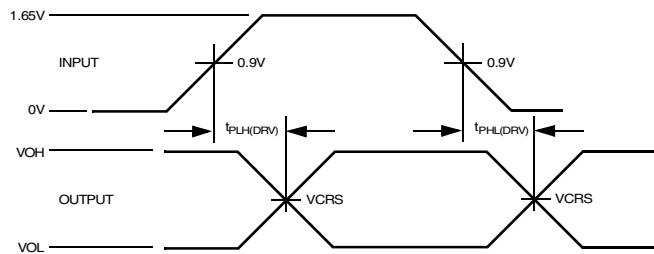

Figure 9. V_O/V_{P0} , F_{SEO}/V_{M0} to D+, D- Timing



Functional Description

The CM2400-01HB USB Transceiver supports 3 different power supply configurations, which can be configured dynamically. Table 1 details the various configurations. In Normal Mode the internal regulator produces 3.3V from V_{BUS} to power the internal drivers and receivers associated with the USB protocol.

V_{BUS}	V_{CC}	CONFIGURATION
Connected	Connected	Normal Mode
Connected	Not Connected	Disable Mode
Not Connected	Connected	Sharing Mode

Table 1: Power Supply Connections

There are three power supply configurations for the CM2400-01HB: Normal mode, Disable mode and Sharing mode. These three modes can be changed dynamically.

Normal mode occurs when the V_{CC} and V_{BUS} inputs are both connected to a source. V_{BUS} is tied to a 5V source for 5V operation. The internal regulator of the CM2400-01HB provides 3.3V output on V_{REG} . The V_{CC} input is connected to an independent source that can range from 1.65V to 3.3V.

When V_{CC} is not connected and V_{BUS} is connected, the device is in Disable mode. The D+ and D- pins are in tri-state and power consumption drops to a suspend state level.

In Sharing mode, V_{CC} is connected while V_{BUS} is below 3.6V. The D+ and D- pins are in tri-state and the CM2400 allows external signals ($\leq 3.6V$) to share these two lines. The CM2400-01HB is designed to draw almost zero current from the D+ and D- lines while in

sharing mode. In this mode, V_P and V_M are driven high while RCV and USB_DET are driven low.

In Disable and Sharing Mode, all input/output pins follow the states defined in Table 2.

PIN	Sharing Mode State	Disable Mode State
V_{BUS}	$V_{BUS} < 3.6V$	4.1V to 5.5V
V_{REG}	Pulled Down	3.3V Out
V_{CC}	Present	Not Present
V_{PU}	High-Z (off)	High-Z (off)
D+, D-	High-Z	High-Z
V_P , V_M	H	Invalid
RCV	L	Invalid
USB_DET	L	Invalid
Inputs	High-Z	High-Z

Table 2: Pin States in Disable or Sharing Mode

Table 3 lists the functions of the modes associated with suspend and \overline{OE} pins. When Suspend is low and \overline{OE} is high, signal levels on D+ and D- are determined by other USB devices and pull-up/down resistors. In Suspend Mode (SPND = HIGH) the differential receiver is inactive and output RCV is always LOW. Out of suspend signaling is detected via the single-ended receivers V_P and V_M . During suspend and while the output is still enabled ($\overline{OE} = LOW$), D+ and D- lines are driven to their intended states.

SUSPEND	\overline{OE}	D+ / D-	RCV	V_P/V_M	Function
L	L	Driver & Receiver Active	Active	Active	Normal driving mode. Differential receiver active
L	H	Receiving	Active	Active	Driver Tri-stated. Differential receiver active.
H	L	Driving	Inactive RCV=L	Active	Driving during 'suspend'. Differential receiver inactive.
H	H	High-Z	Inactive RCV=L	Active	Low-power state.

Table 3: Function Selection.



Functional Description (cont'd)

Detailed in Table 4 and Table 5 are the operating modes selected when MODE is set to LOW and HIGH. When MODE = HIGH, the differential input data interface mode is selected. The two driver inputs function as V_{MO} and V_{PO} . When MODE = LOW, the single-ended input data interface mode is selected. The two driver inputs function as FSE0 and V_O .

MODE	V_O	FSE0	Result
L (single-ended)	L	L	Logic '0'
	L	H	SE0
	H	L	Logic '1'
	H	H	SE0

Table 4: Operating Mode ($\overline{OE} = L$)

MODE	V_O	FSE0	Result
H (differential)	L	L	SE0
	L	H	Logic '0'
	H	L	Logic '1'
	H	H	Undefined

Table 5: Operating Mode ($\overline{OE} = L$)

Table 6 details the receiving function when \overline{OE} is HIGH (driver disabled). RCV denotes the signal level on the output RCV just before an SE0 state occurs. This level is stable during the SE0 period.

D+/D-	RCV	V_P	V_M
Differential Logic '0'	L	L	H
Differential Logic '1'	H	H	L
SE0	RCV*	L	L

Table 6: Receiving Function (SPND = L)

Note 1: Denotes RCV is stable in last state before SE0 condition.

Detection of a V_{BUS} voltage is accomplished via an internal Comparator with hysteresis. The output from this Comparator is fed via the level translator to ensure compatibility with processor core voltages and output to pin USB_DET. When V_{BUS} is over 4.1V, USB_DET is HIGH. When V_{BUS} is under 3.6V, USB_DET is LOW.

The CM2400-01HB USB transceiver includes an enumeration pin (ENUM) which internally connects V_{PU} to V_{REG} when enabled. This allows a processor running at a core voltage different than 3.3V to switch the pull-up resistor in and out without the need for external circuitry.

Application Information

The CM2400-01 transceiver is targeted for full-speed (12Mbps/s) USB peripherals including handheld electronic devices such as PDAs and cell phones. It provides the interface between the core I/O signals (within a range of 1.65V and 3.6V) and the USB data lines (D+ and D-) operating at 3.3V.

This section describes how the USB transceiver interfaces to the USB port and to the controller or ASIC on the other side. A small number of external components is needed that includes two 33Ω series resistors for termination, two capacitors for filtering, and a 1.5KΩ pull-up resistor on the D+ data line to configure full-speed (12Mbps/second) operation. This pull-up resistor is tied to the V_{PU} pin which internally connects to V_{REG} (3.3V) when ENUM is set High. An internal switch dis-

nects V_{PU} from V_{REG} (V_{PU} floating or high impedance) when ENUM is set Low.

CAMD offers the PACUSB-U2 filter, available in both the SC70 and SOT23 6-lead packages, that integrates all these components as well as the additional ESD protection rated to 15kV per the IEC61000-4-2 standard (exceeding level 4). Figure 10 shows a typical electrical schematic for a USB peripheral application.

The driver output resistance for the full-speed driver, should be between 28Ω and 44Ω (refer to the USB Specification section 7.1.1.1). Since the CM2400-01 output impedance is about 6Ω it is recommended that 33Ω series resistors be used.

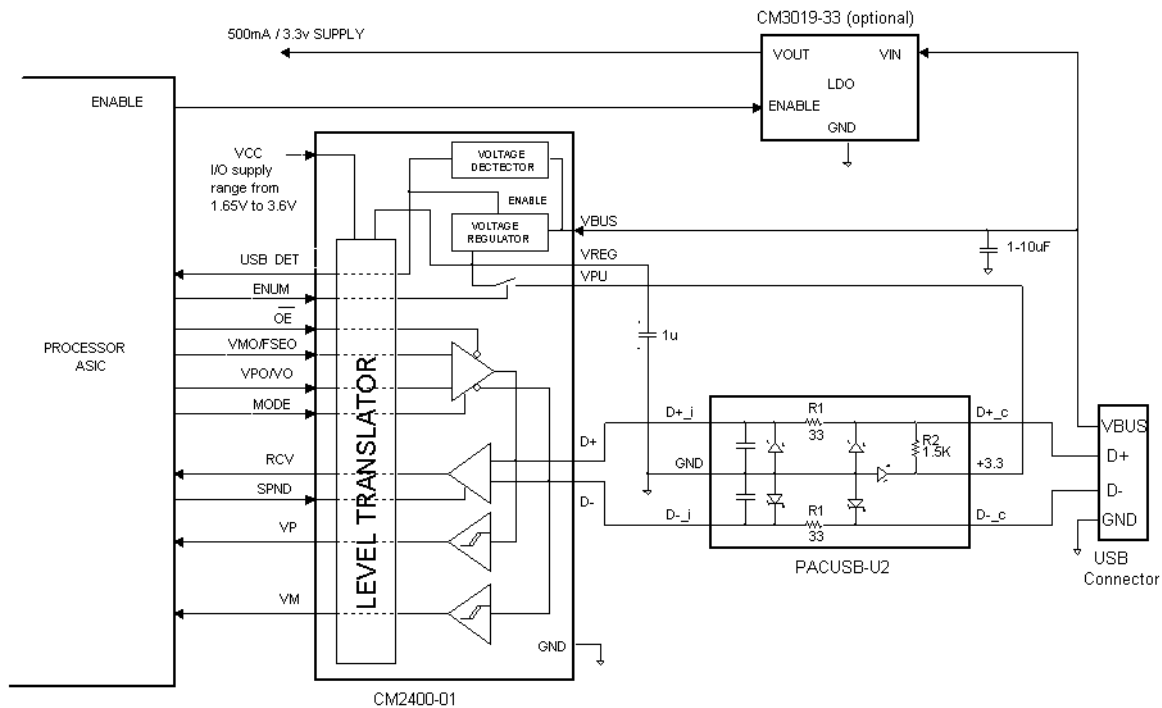

Figure 10. Schematic for USB Peripheral Device

- The MODE pin selects the differential receiver mode when High (CMOS level or V_{CC}), and selects the single-ended receiver mode when Low (connected to GND).
- The CM2400-01 is used in bus-powered systems only, where the V_{BUS} supply pin is connected to the +5V V_{BUS} line from the USB connector.
- The V_{CC} supply pin is the supply for the I/O signal logic that provide the interface with the ASIC. The V_{CC} supply must range between 1.65V min and 3.6V max.



Application Information (cont'd)

The CM2400-01HB includes an internal 3.3V LDO that powers the transceiver from the V_{BUS} . A capacitor (1 μ F typical) is required on the regulator output (V_{REG} pin). This output can only be used to power a limited external load of a few milliamperes (mA). For USB-powered peripheral applications, the 5V V_{BUS} line can be regulated down to 3.3V or a lower voltage as shown in Figure 10, using a CM3019 regulator. This regulator provides excellent line and load regulation as well as current limit and thermal overload protection.

The USB specification recommends the use of a 1 μ F to 10 μ F capacitor to be connected to the 5V V_{BUS} .

Please contact factory at 800-325-4966 to request on the availability of evaluation boards.



Mechanical Details

The CM2400-01HB is available in a 16-pin HBCC package.

HBCC16 Mechanical Specifications

Dimensions for CM2400-01HB devices packaged in 16-pin HBCC packages are presented below.

PACKAGE DIMENSIONS				
Package	HBCC16			
Pins	16			
Dimensions	Millimeters		Inches	
	Min	Max	Min	Max
A	-	0.80		0.0315
A ₁	0.05	0.10		0.0039
b ₁	0.25	0.35		0.0138
b ₂	0.30	0.40		0.0157
b ₃	0.30	0.40		0.0157
D	2.90	3.10		0.1220
D _h	1.45	1.55		0.0610
E	2.90	3.10		0.1220
E _h	1.75	1.85		0.0728
e	0.50 TYP.		0.0197 TYP.	
e ₁	2.50 TYP.		0.0984 TYP.	
e ₂	2.50 TYP.		0.0984 TYP.	
e ₃	2.45 TYP.		0.0965 TYP.	
e ₄	2.45 TYP.		0.0965 TYP.	
# per tube	120 pieces*			
# per tape and reel	2500 pieces			
Controlling dimension: millimeters				

* This is an approximate number which may vary.

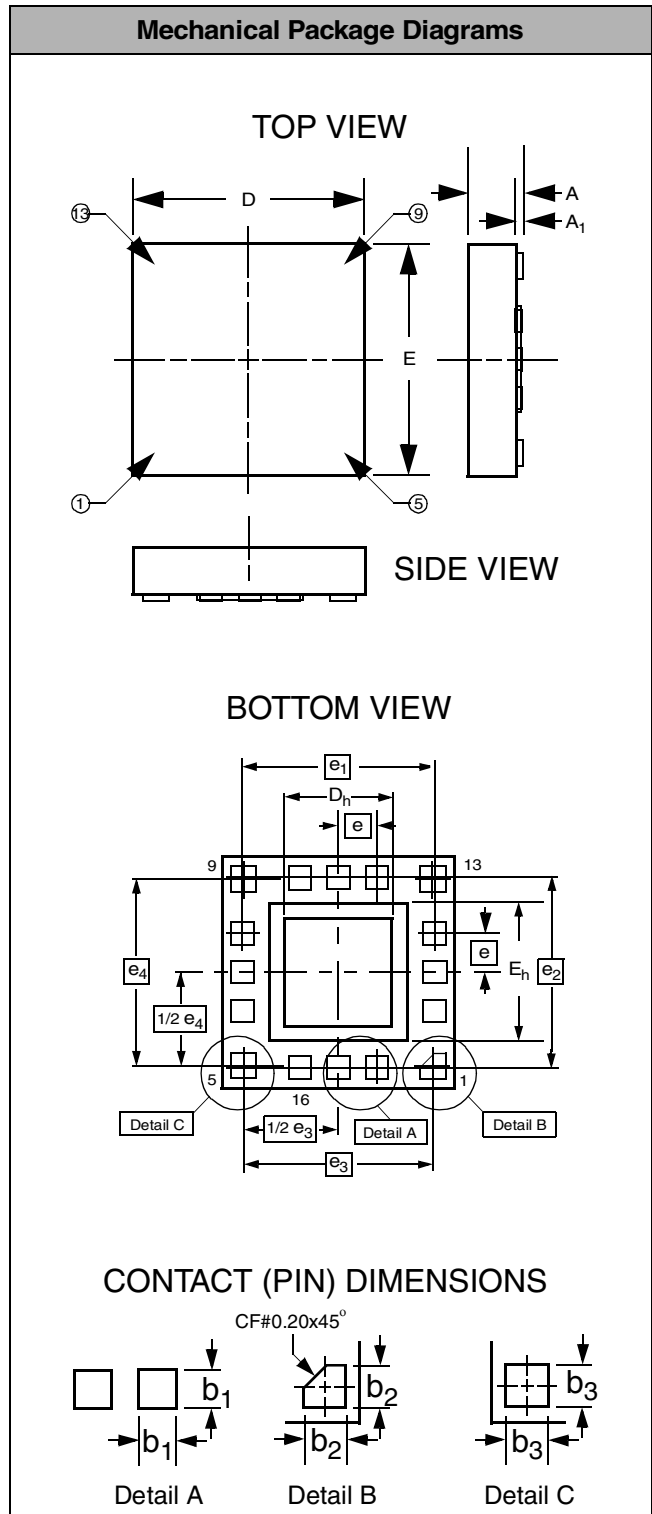

Dimensions for HBCC16 Package