

SERIES E G SWITCHES

SLIDE SWITCHES

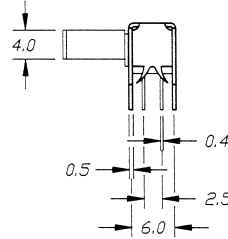

2219

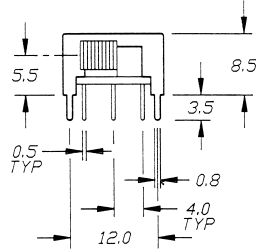
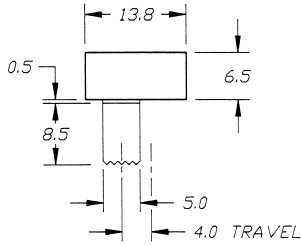

P.C. MOUNTING

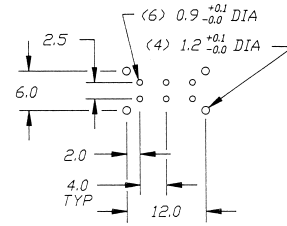

Schematic

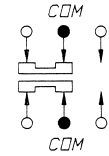

2301

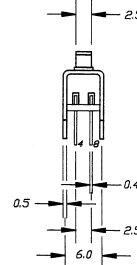
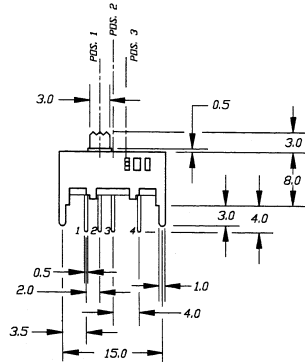
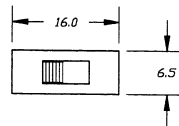

P.C. MOUNTING

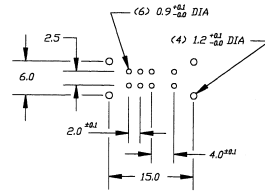

Schematic

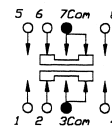

Model No.	L
EG2301	3
EG2301A	6
EG2301B	9
EG2301C	12



2303

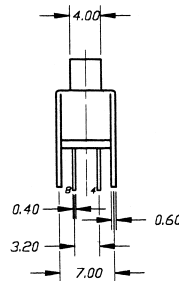
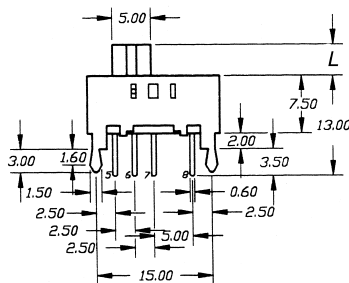
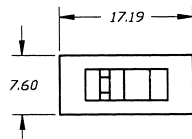

P.C. MOUNTING

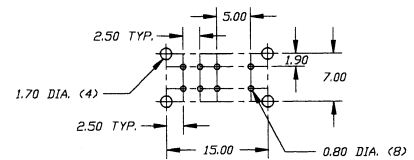

Schematic

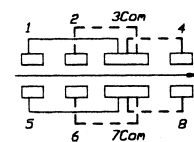

SPECIFICATIONS SUBJECT TO CHANGE WITHOUT NOTICE.

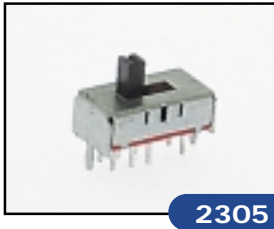

2305

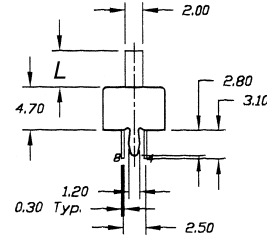
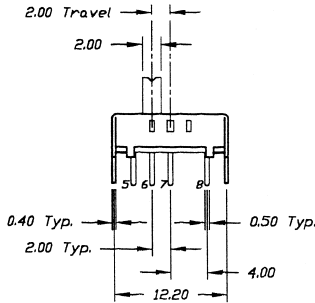
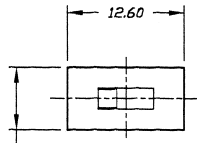

P.C. MOUNTING

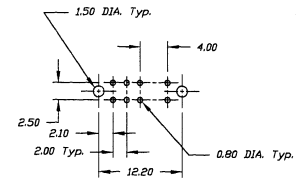

Schematic

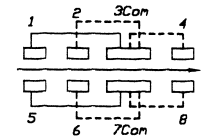

Model No.	L
EG2305	4
EG2305A	2

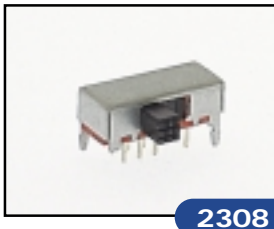

2308

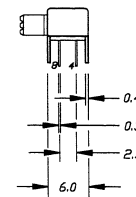
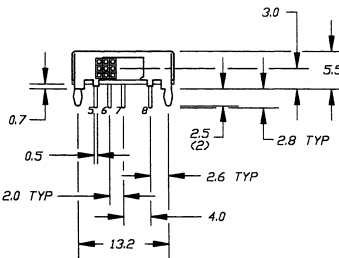
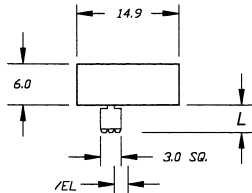

P.C. MOUNTING

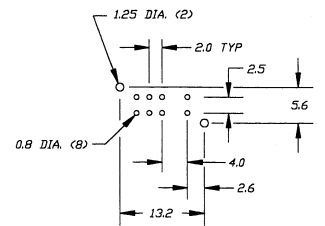

Schematic

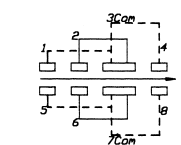

Model No.	L
EG2308	4
EG2308A	6



2310

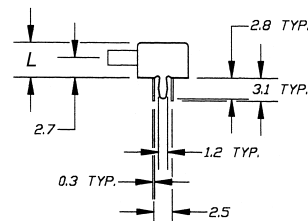
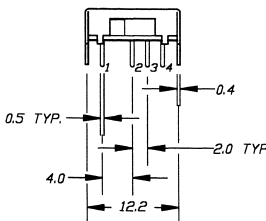
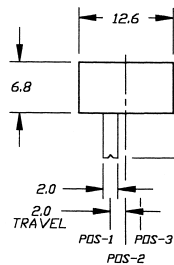

P.C. MOUNTING

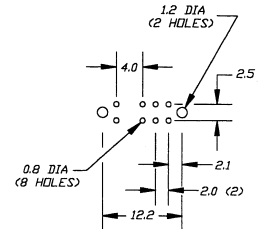

Schematic

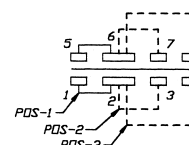

Model No.	L
EG2310	6
EG2310A	4

SPECIFICATIONS SUBJECT TO CHANGE WITHOUT NOTICE.

SERIES E G SWITCHES

SLIDE SWITCHES



2315

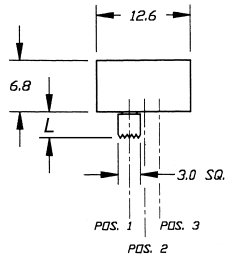

P.C. MOUNTING

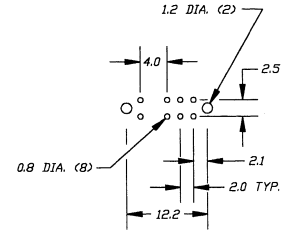

Model No.	L
EG2315	3.5
EG2315A	6

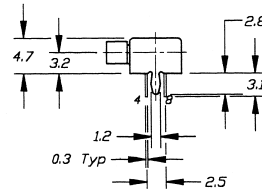
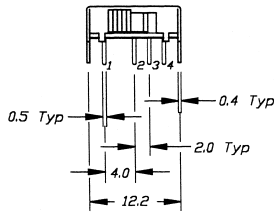

Schematic

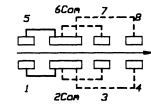

2319

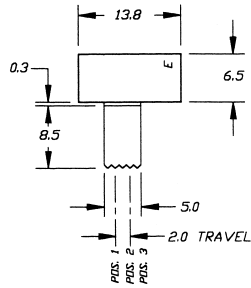

P.C. MOUNTING

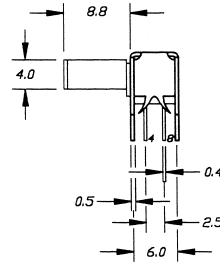
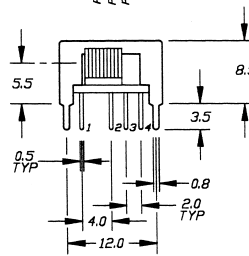
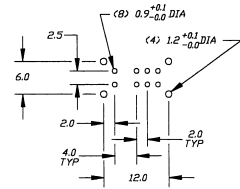

Schematic

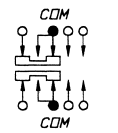

2322

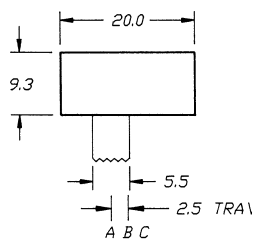

P.C. MOUNTING

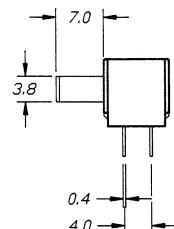
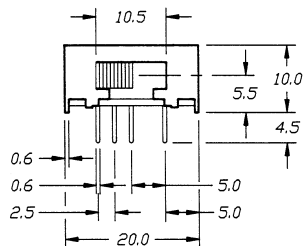
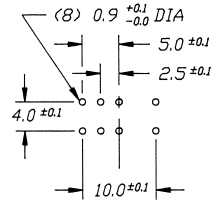

Schematic

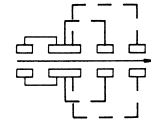

SPECIFICATIONS SUBJECT TO CHANGE WITHOUT NOTICE.

SERIES E G SWITCHES

SLIDE SWITCHES



2323

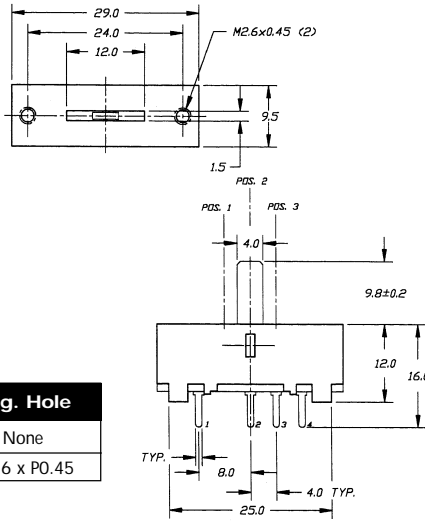

P.C. MOUNTING

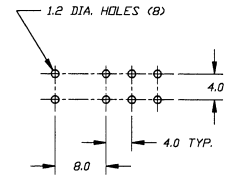

Model No.	Mtg. Hole
EG2323	None
EG2323A	M2.6 x P0.45

Schematic

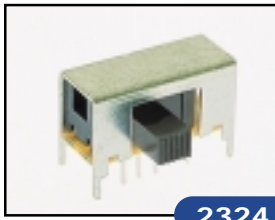
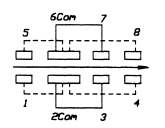

2324

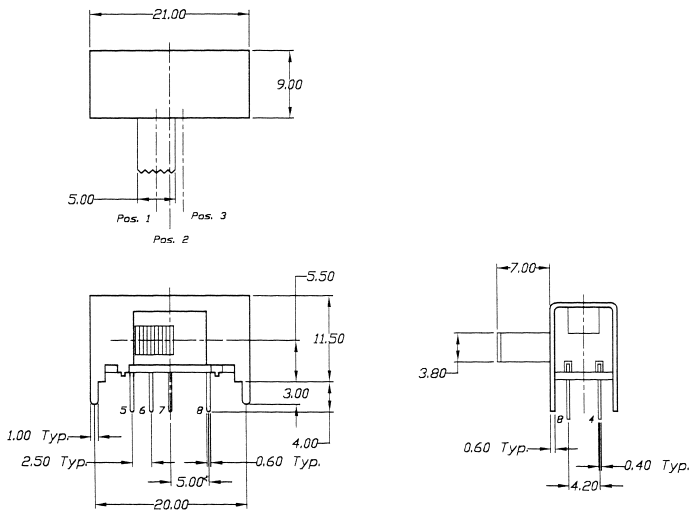

P.C. MOUNTING

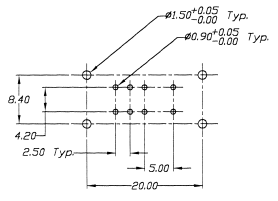

Schematic

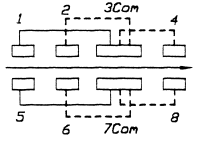

SPECIFICATIONS SUBJECT TO CHANGE WITHOUT NOTICE.



2325

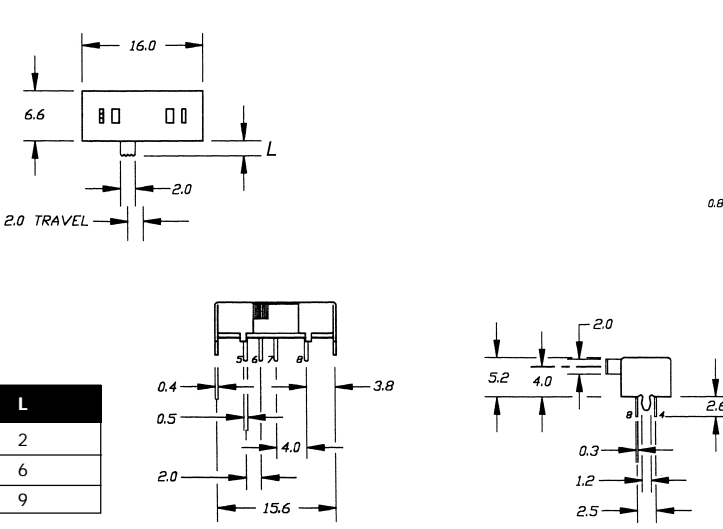

P.C. MOUNTING

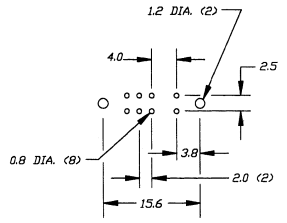

Model No.	L
EG2325	2
EG2325A	6
EG2325B	9

Schematic

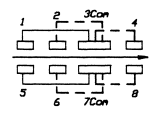

SERIES EG SWITCHES

SLIDE SWITCHES

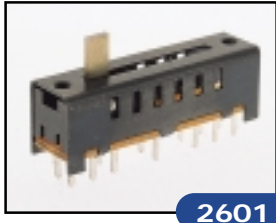

2601

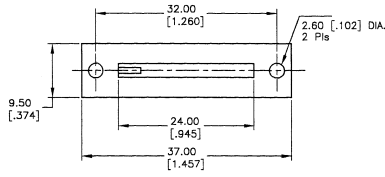

P.C. MOUNTING

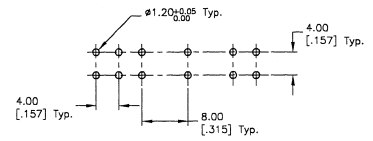

Model No.	L	"A"
EG2601	9.8	None
EG2601A	9.8	M2.6 x P0.45
EG2601B	6.5	M2.6 x P0.45
EG2601C	6.5	None

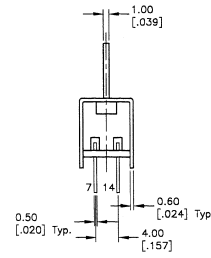
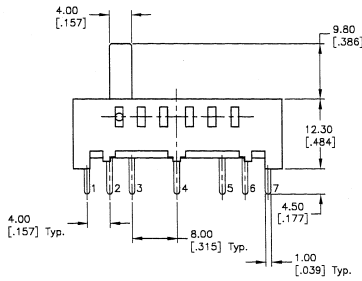

Schematic

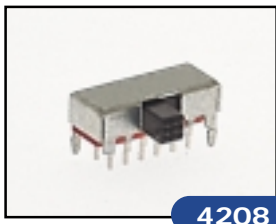
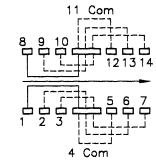

4208

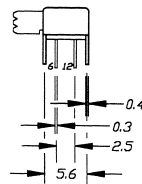
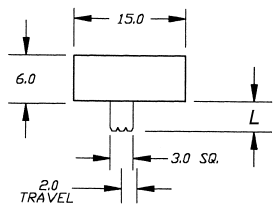

P.C. MOUNTING

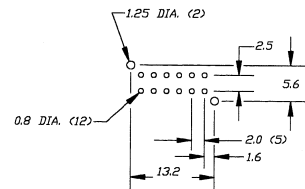

Model No.	L
EG4208	4
EG4208A	6

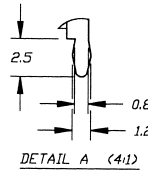
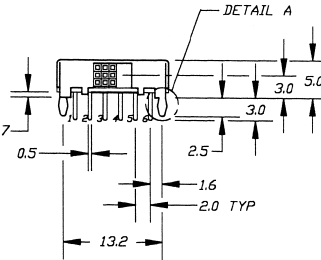

Schematic

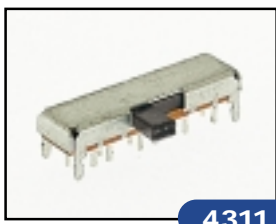
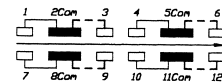

4311

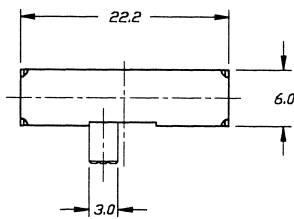

P.C. MOUNTING

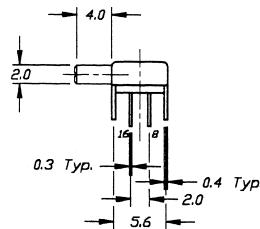
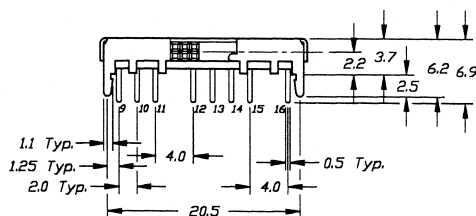
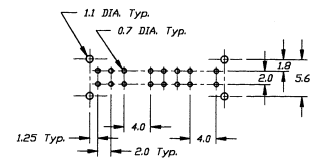

Schematic

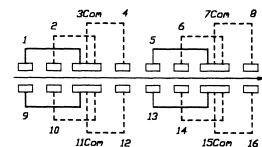

SPECIFICATIONS SUBJECT TO CHANGE WITHOUT NOTICE.

SERIES E G SWITCHES

SLIDE SWITCHES

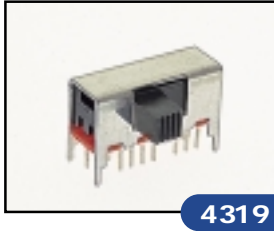

4319

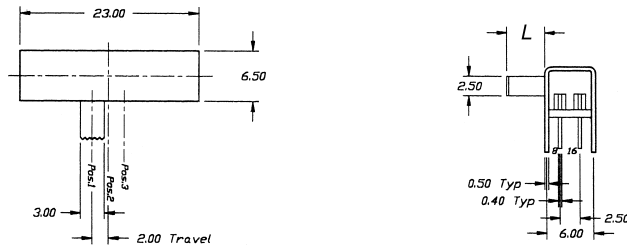

P.C. MOUNTING

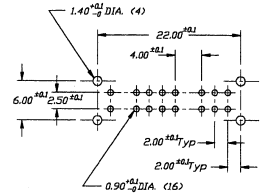

Model No.	L
EG4319	5
EG4319A	6

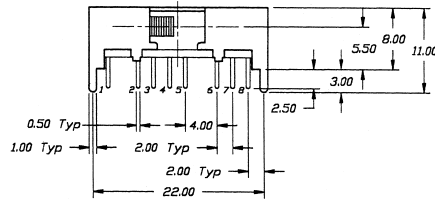

Schematic

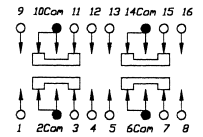

6201

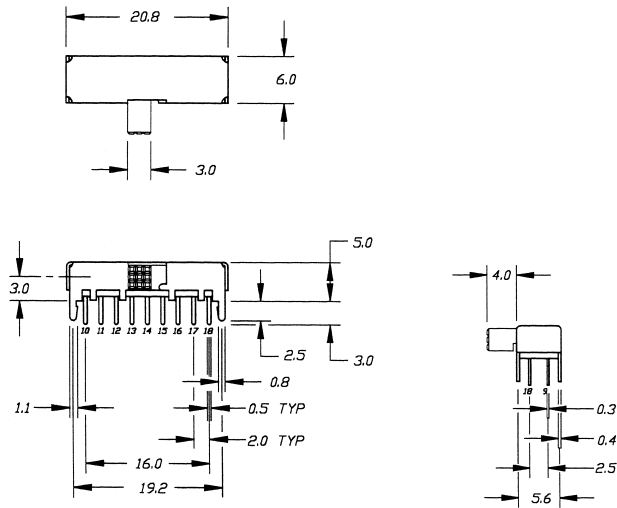

P.C. MOUNTING

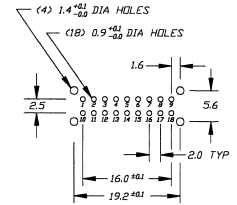

Schematic

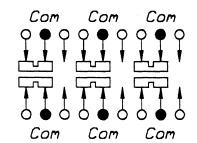

SPECIFICATIONS SUBJECT TO CHANGE WITHOUT NOTICE.