

# MURA205T3, MURA210T3

Preferred Devices

## Surface Mount Ultrafast Power Rectifiers

Ideally suited for high voltage, high frequency rectification, or as free wheeling and protection diodes in surface mount applications where compact size and weight are critical to the system.

### Features

- Small Compact Surface Mountable Package with J-Bend Leads
- Rectangular Package for Automated Handling
- High Temperature Glass Passivated Junction
- Low Forward Voltage Drop (0.74 V Max @ 2.0 A,  $T_J = 150^\circ\text{C}$ )
- Pb-Free Packages are Available

### Mechanical Characteristics:

- Case: Epoxy, Molded
- Weight: 70 mg (Approximately)
- Finish: All External Surfaces Corrosion Resistant and Terminal Leads are Readily Solderable
- Lead and Mounting Surface Temperature for Soldering Purposes:  $260^\circ\text{C}$  Max. for 10 Seconds
- Polarity: Polarity Band Indicates Cathode Lead
- ESD Protection: Human Body Model > 4000 V (Class 3)  
Machine Model > 400 V (Class C)

### MAXIMUM RATINGS

Rating	Symbol	Value	Unit
Peak Repetitive Reverse Voltage Working Peak Reverse Voltage DC Blocking Voltage	$V_{RRM}$ $V_{RWM}$ $V_R$	50 100	V
Average Rectified Forward Current @ $T_L = 155^\circ\text{C}$ @ $T_L = 135^\circ\text{C}$	$I_{F(AV)}$	1.0 2.0	A
Non-Repetitive Peak Surge Current (Surge Applied at Rated Load Conditions Halfwave, Single Phase, 60 Hz)	$I_{FSM}$	50	A
Operating Junction Temperature Range	$T_J$	-65 to +175	$^\circ\text{C}$

### THERMAL CHARACTERISTICS

Characteristic	Symbol	Max	Unit
Thermal Resistance, Junction-to-Lead ( $T_L = 25^\circ\text{C}$ ) (Note 1)	$\Psi_{jL}$ (Note 2)	24	$^\circ\text{C}/\text{W}$
Thermal Resistance, Junction-to-Ambient (Note 1)	$R_{\theta JA}$	216	

Maximum ratings are those values beyond which device damage can occur. Maximum ratings applied to the device are individual stress limit values (not normal operating conditions) and are not valid simultaneously. If these limits are exceeded, device functional operation is not implied, damage may occur and reliability may be affected.

1. Rating applies when surface mounted on the minimum pad size recommended, PC Board FR-4.
2. In compliance with JEDEC 51, these values (historically represented by  $R_{\theta JL}$ ) are now referenced as  $\Psi_{jL}$ .



ON Semiconductor®

<http://onsemi.com>

## ULTRAFAST RECTIFIERS 2 AMPERES, 50-100 VOLTS



SMA  
CASE 403D  
PLASTIC

### MARKING DIAGRAM

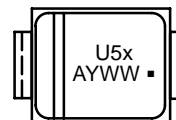

U5x = Device Code  
x = A for MURA205T3  
= B for MURA210T3  
A = Assembly Location  
Y = Year  
WW = Work Week  
▪ = Pb-Free Package

### ORDERING INFORMATION

Device	Package	Shipping†
MURA205T3	SMA	5000/Tape & Reel
MURA205T3G	SMA (Pb-Free)	5000/Tape & Reel
MURA210T3	SMA	5000/Tape & Reel
MURA210T3G	SMA (Pb-Free)	5000/Tape & Reel

†For information on tape and reel specifications, including part orientation and tape sizes, please refer to our Tape and Reel Packaging Specifications Brochure, BRD8011/D.

Preferred devices are recommended choices for future use and best overall value.

# MURA205T3, MURA210T3

## ELECTRICAL CHARACTERISTICS

Characteristic	Symbol	Max	Unit
Maximum Instantaneous Forward Voltage (Note 3) ( $i_F = 2.0 \text{ A}$ , $T_J = 25^\circ\text{C}$ ) ( $i_F = 2.0 \text{ A}$ , $T_J = 150^\circ\text{C}$ )	$v_F$	0.94 0.74	V
Maximum Instantaneous Reverse Current (Note 3) (Rated DC Voltage, $T_J = 25^\circ\text{C}$ ) (Rated DC Voltage, $T_J = 150^\circ\text{C}$ )	$i_R$	2.0 50	$\mu\text{A}$
Maximum Reverse Recovery Time ( $i_F = 1.0 \text{ A}$ , $di/dt = 50 \text{ A}/\mu\text{s}$ )	$t_{rr}$	30	ns

3. Pulse Test: Pulse Width = 300  $\mu\text{s}$ , Duty Cycle  $\leq 2.0\%$ .

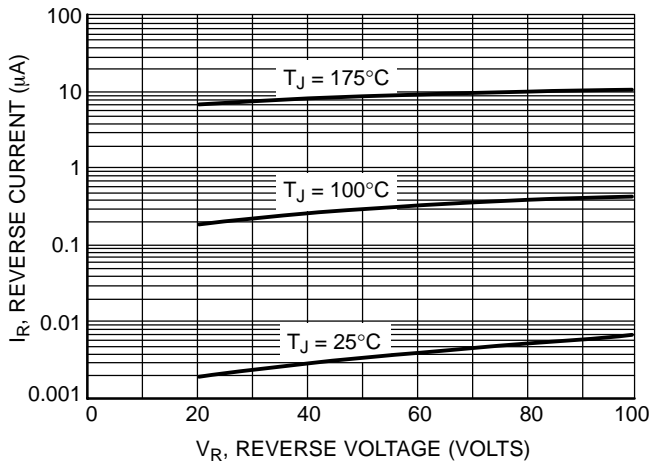

Figure 1. Typical Reverse Current

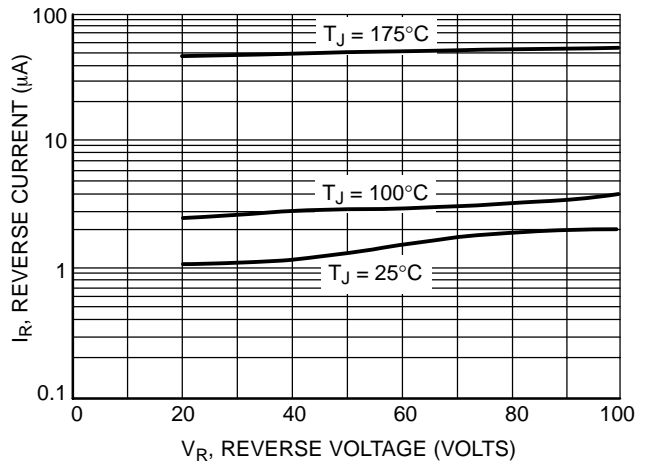

Figure 2. Maximum Reverse Current

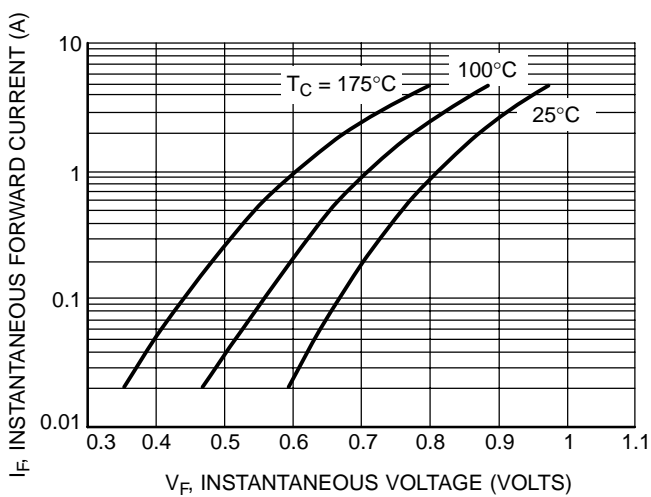

Figure 3. Typical Forward Voltage

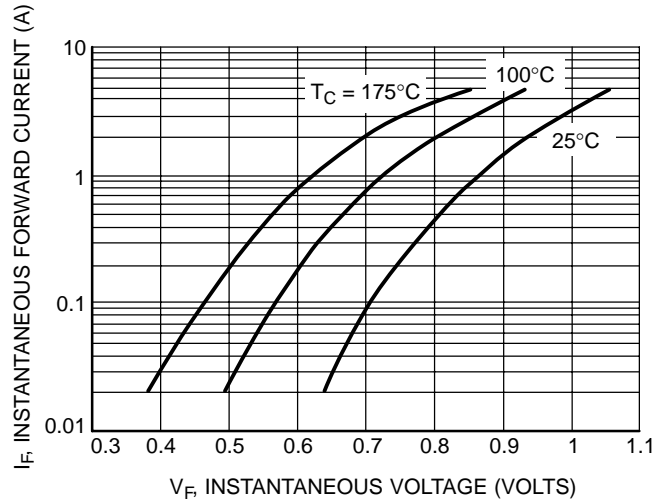

Figure 4. Maximum Forward Voltage

# MURA205T3, MURA210T3

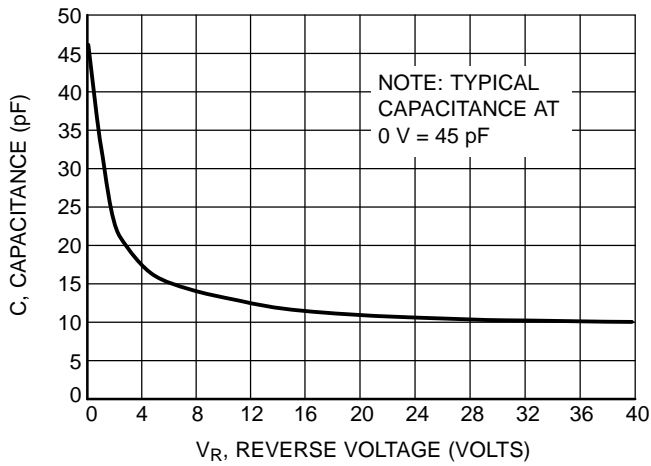

Figure 5. Typical Capacitance

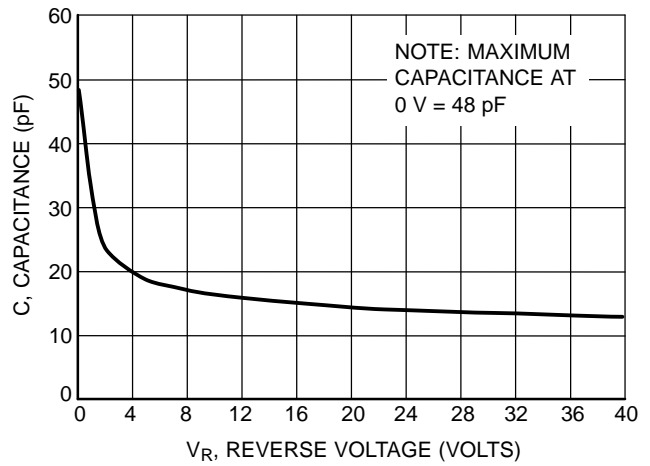

Figure 6. Maximum Capacitance

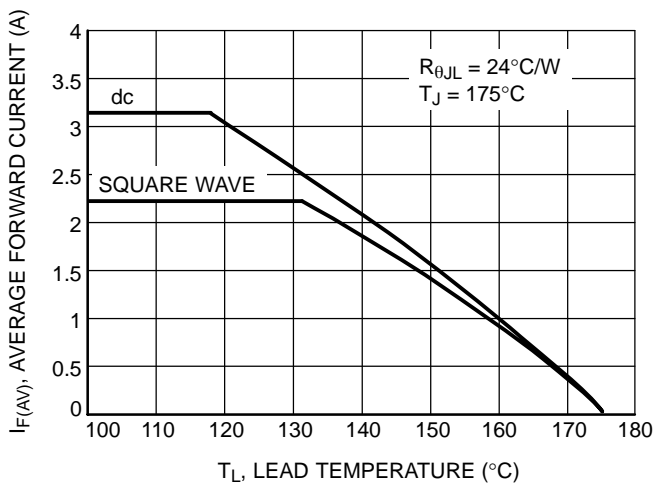

Figure 7. Current Derating, Lead

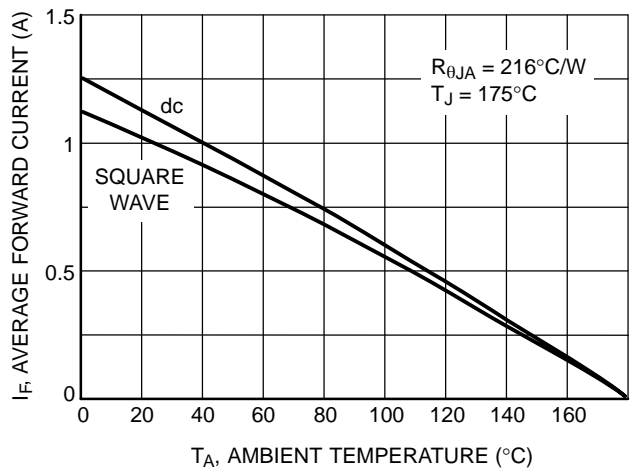

Figure 8. Current Derating, Ambient (FR-4 Board with Minimum Pad)

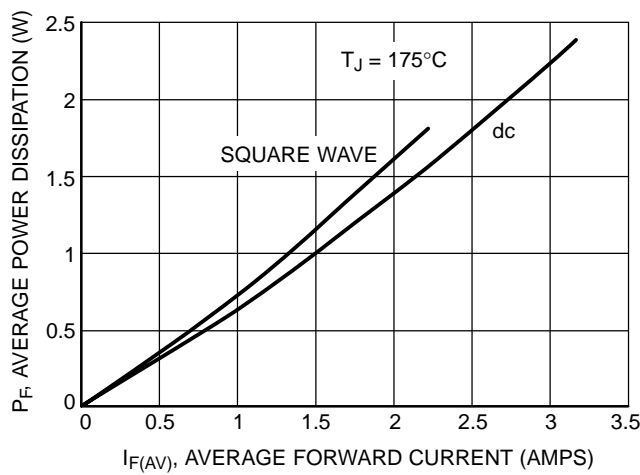
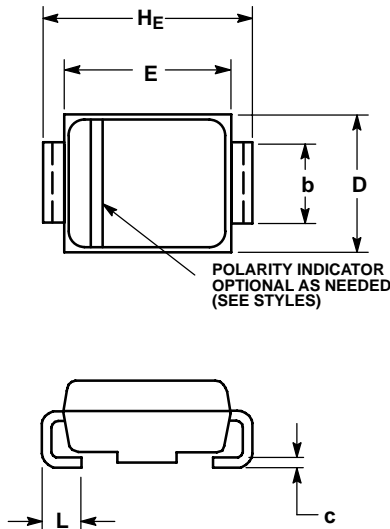

Figure 9. Power Dissipation

# MURA205T3, MURA210T3

## PACKAGE DIMENSIONS

### SMA CASE 403D-02 ISSUE C



- NOTES:
1. DIMENSIONING AND TOLERANCING PER ANSI Y14.5M, 1982.
  2. CONTROLLING DIMENSION: INCH.
  3. 403D-01 OBSOLETE, NEW STANDARD IS 403D-02.

DIM	MILLIMETERS			INCHES		
	MIN	NOM	MAX	MIN	NOM	MAX
A	1.91	2.16	2.41	0.075	0.085	0.095
A1	0.05	0.10	0.15	0.002	0.004	0.006
b	1.27	1.45	1.63	0.050	0.057	0.064
c	0.15	0.28	0.41	0.006	0.011	0.016
D	2.29	2.60	2.92	0.090	0.103	0.115
E	4.06	4.32	4.57	0.160	0.170	0.180
HE	4.83	5.21	5.59	0.190	0.205	0.220
L	0.76	1.14	1.52	0.030	0.045	0.060

- STYLE 1:  
PIN 1. CATHODE (POLARITY BAND)  
2. ANODE

### SOLDERING FOOTPRINT\*

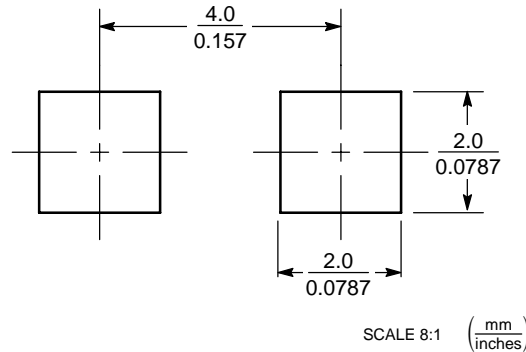

\*For additional information on our Pb-Free strategy and soldering details, please download the ON Semiconductor Soldering and Mounting Techniques Reference Manual, SOLDERRM/D.

ON Semiconductor and are registered trademarks of Semiconductor Components Industries, LLC (SCILLC). SCILLC reserves the right to make changes without further notice to any products herein. SCILLC makes no warranty, representation or guarantee regarding the suitability of its products for any particular purpose, nor does SCILLC assume any liability arising out of the application or use of any product or circuit, and specifically disclaims any and all liability, including without limitation special, consequential or incidental damages. "Typical" parameters which may be provided in SCILLC data sheets and/or specifications can and do vary in different applications and actual performance may vary over time. All operating parameters, including "Typicals" must be validated for each customer application by customer's technical experts. SCILLC does not convey any license under its patent rights nor the rights of others. SCILLC products are not designed, intended, or authorized for use as components in systems intended for surgical implant into the body, or other applications intended to support or sustain life, or for any other application in which the failure of the SCILLC product could create a situation where personal injury or death may occur. Should Buyer purchase or use SCILLC products for any such unintended or unauthorized application, Buyer shall indemnify and hold SCILLC and its officers, employees, subsidiaries, affiliates, and distributors harmless against all claims, costs, damages, and expenses, and reasonable attorney fees arising out of, directly or indirectly, any claim of personal injury or death associated with such unintended or unauthorized use, even if such claim alleges that SCILLC was negligent regarding the design or manufacture of the part. SCILLC is an Equal Opportunity/Affirmative Action Employer. This literature is subject to all applicable copyright laws and is not for resale in any manner.

### PUBLICATION ORDERING INFORMATION

**LITERATURE FULFILLMENT:**  
Literature Distribution Center for ON Semiconductor  
P.O. Box 61312, Phoenix, Arizona 85082-1312 USA  
**Phone:** 480-829-7710 or 800-344-3860 Toll Free USA/Canada  
**Fax:** 480-829-7709 or 800-344-3867 Toll Free USA/Canada  
**Email:** orderlit@onsemi.com

**N. American Technical Support:** 800-282-9855 Toll Free USA/Canada

**Japan:** ON Semiconductor, Japan Customer Focus Center  
2-9-1 Kamimeguro, Meguro-ku, Tokyo, Japan 153-0051  
**Phone:** 81-3-5773-3850

**ON Semiconductor Website:** <http://onsemi.com>

**Order Literature:** <http://www.onsemi.com/litorder>

For additional information, please contact your local Sales Representative.