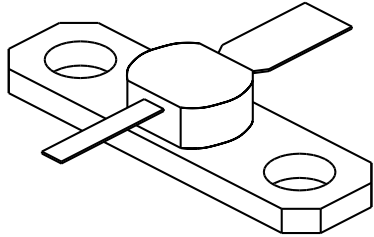

2307

7.0 Watts - 20 Volts, Class C
Microwave 2300 MHz

<p>GENERAL DESCRIPTION The 2307 is a COMMON BASE transistor capable of providing 7 Watts Class C, RF output power at 2300 MHz. Gold metalization and diffused ballasting are used to provide high reliability and supreme ruggedness. The transistor uses a fully hermetic High Temperature Solder Sealed package.</p>	<p>CASE OUTLINE 55 BT- Style 1</p> 
<p>ABSOLUTE MAXIMUM RATINGS</p> <p>Maximum Power Dissipation @ 25°C 20.5 Watts</p> <p>Maximum Voltage and Current</p> <p>BVces Collector to Emitter Voltage 42 Volts BVebo Emitter to Base Voltage 3.5 Volts Ic Collector Current 1.0 A</p> <p>Maximum Temperatures</p> <p>Storage Temperature - 65 to + 200°C Operating Junction Temperature + 200°C</p>	

ELECTRICAL CHARACTERISTICS @ 25 °C

SYMBOL	CHARACTERISTICS	TEST CONDITIONS	MIN	TYP	MAX	UNITS
Pout	Power Out	F = 2.3 GHz	7.0			Watt
Pin	Power Input	Vcb = 20 Volts			1.1	Watt
Pg	Power Gain	Po = 7 Watts	8.0			dB
η_c	Collector Efficiency	As Above		40		%
VSWR₁	Load Mismatch Tolerance	F = 2.3 GHz, Po = 7 W			30:1	

BVces	Collector to Emitter Breakdown	Ic = 50 mA	42			Volts
BVebo	Emitter to Base Breakdown	Ie = 5.0 mA	3.5			Volts
Icbo	Collector to Base Current	Vcb = 22 Volts			2.5	mA
h_{FE}	Current Gain	Vce = 5 V, Ic = 500 mA	10			
Cob	Output Capacitance	F = 1.0 MHz, Vcb = 22 V		10		pF
θ_{jc}	Thermal Resistance				8.5	°C/W

Issue August 1996

GHz TECHNOLOGY INC. RESERVES THE RIGHT TO MAKE CHANGES WITHOUT FURTHER NOTICE. GHz RECOMMENDS THAT BEFORE THE PRODUCT(S) DESCRIBED HEREIN ARE WRITTEN INTO SPECIFICATIONS, OR USED IN CRITICAL APPLICATIONS, THAT THE PERFORMANCE CHARACTERISTICS BE VERIFIED BY CONTACTING THE FACTORY.

POWER OUTPUT VS FREQUENCY

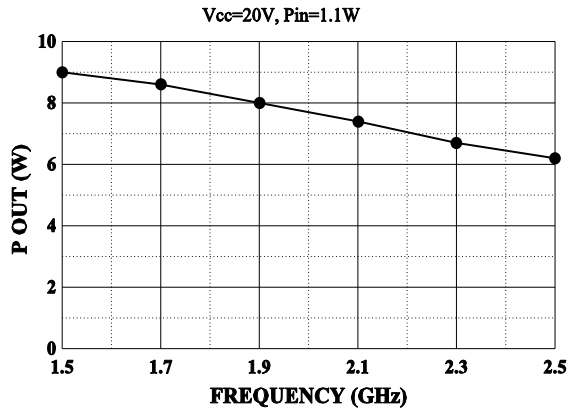

EFFICIENCY VS FREQUENCY

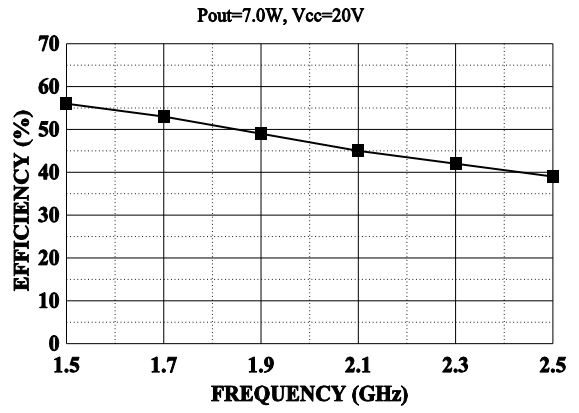

INPUT IMPEDANCE

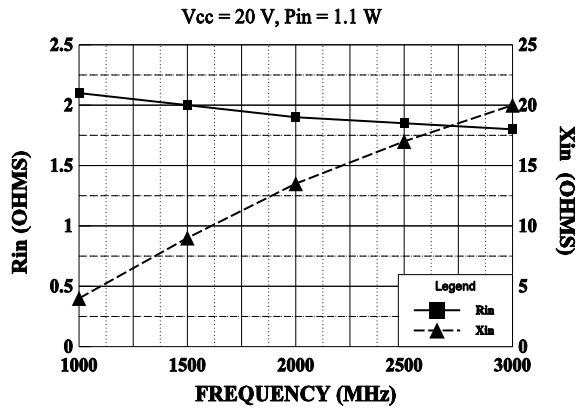

LOAD IMPEDANCE

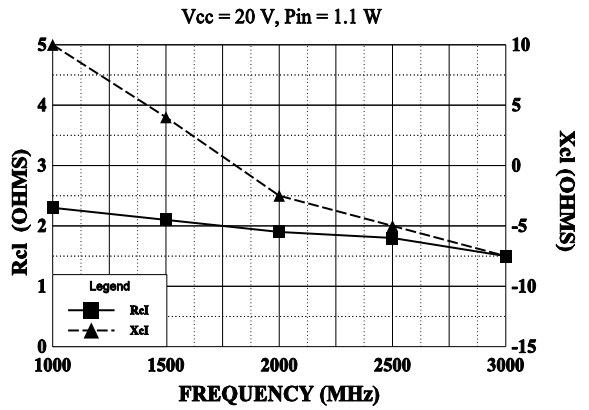

SMITH CHART

2307

NORMALIZED IMPEDANCE AND ADMITTANCE COORDINATES

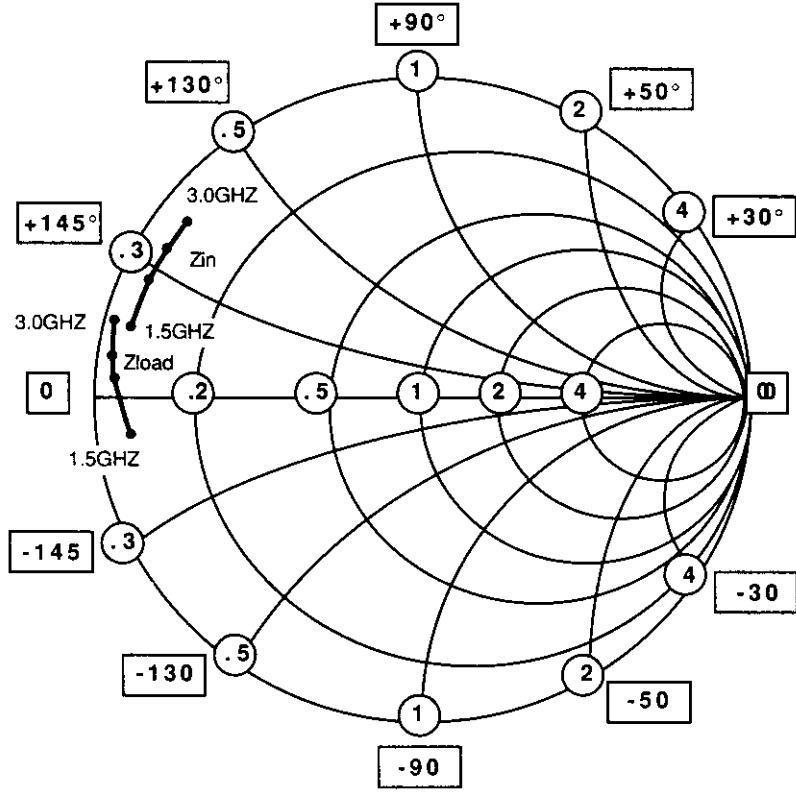

NORMALIZED TO A 50 OHM SYSTEM.

FREQUENCY MHz	R	Z _{in}	JX	FREQUENCY MHz	R	Z _{load}	JX
1500	2	8	8	1500	2.1	5	5
2000	1.9	14	14	2000	1.9	-3	-3
2300	1.85	17	17	2300	1.8	-5	-5
3000	1.8	20	20	3000	1.5	-7.5	-7.5

REVISIONS

ZONE	REV	DESCRIPTION	DATE	APPROVED
------	-----	-------------	------	----------

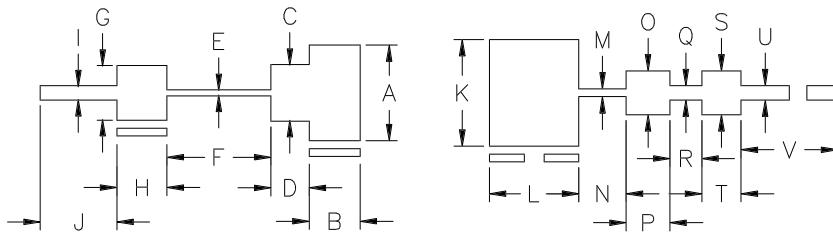

DIM	INCHES
A	.525
B	.280
C	.310
D	.210
E	.033
F	.570
G	.300
H	.275
I	.078
J	.420
K	.585
L	.490
M	.042
N	.260
O	.240
P	.240
Q	.078
R	.175
S	.240
T	.215
U	.078
V	.530

2307 TEST CIRCUIT

F = 2.3 GHz

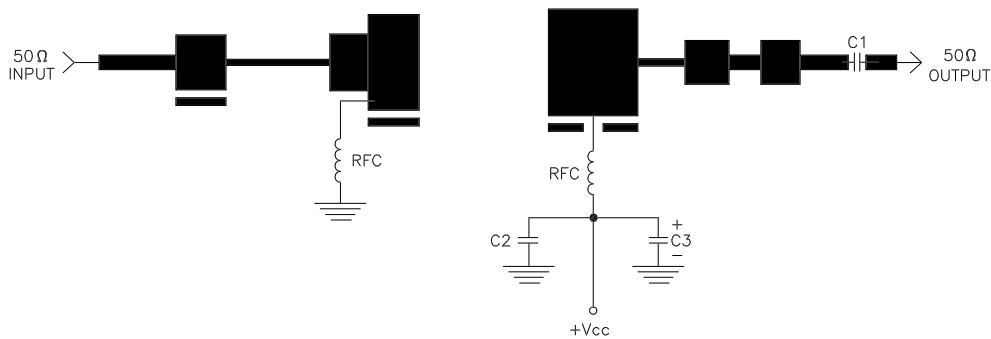

— = Microstrip on 0.020" Duroid, Er=2.55
 C1, C2 = 68pF ATC "A"
 C3 = 10MFD @ 35V



CAGE OPJR2	DWG NO. 2307	REV A
	SCALE 1/1	SHEET