



ELECTROSTATIC SENSITIVE DEVICE
OBSERVE HANDLING PRECAUTIONS

MITSUBISHI RF POWER MOS FET

RD07MVS2

RoHS Compliance, Silicon MOSFET Power Transistor, 175MHz, 520MHz, 7W

DESCRIPTION

RD07MVS2 is a MOS FET type transistor specifically designed for VHF/UHF RF power amplifiers applications. This device has an internal monolithic zener diode from gate to source for ESD protection.

FEATURES

- High power gain:
Pout > 7W, Gp > 10dB
@ Vdd = 7.2V, f = 520MHz
- High Efficiency: 60% typ. (175MHz)
- High Efficiency: 55% typ. (520MHz)
- Integrated gate protection diode

APPLICATION

For output stage of high power amplifiers
In VHF/UHF band mobile radio sets.

OUTLINE DRAWING

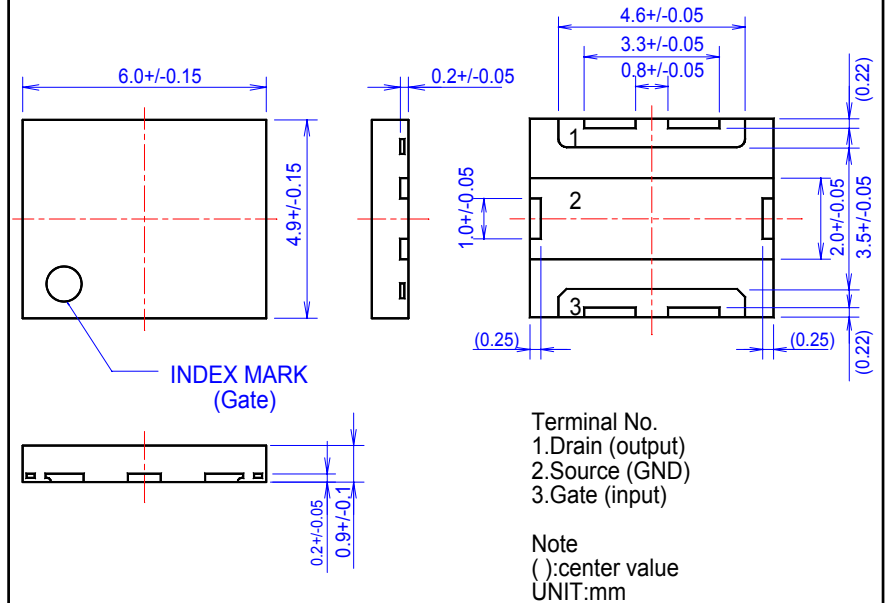

RoHS COMPLIANT

RD07MVS2-101, T112 is a RoHS compliant product.
RoHS compliance is indicated by the letter "G" after the Lot Marking.
This product includes the lead in high melting temperature type solders.
However, it is applicable to the following exceptions of RoHS Directives.
1. Lead in high melting temperature type solders (i.e. tin-lead solder alloys containing more than 85% lead.)

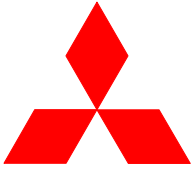

ELECTROSTATIC SENSITIVE DEVICE
OBSERVE HANDLING PRECAUTIONS

MITSUBISHI RF POWER MOS FET

RD07MVS2

RoHS Compliance, Silicon MOSFET Power Transistor, 175MHz, 520MHz, 7W

ABSOLUTE MAXIMUM RATINGS

(T_c=25°C UNLESS OTHERWISE NOTED)

SYMBOL	PARAMETER	CONDITIONS	RATINGS	UNIT
VDSS	Drain to source voltage	V _{gs} =0V	30	V
VGSS	Gate to source voltage	V _{ds} =0V	-5/+10	V
P _{ch}	Channel dissipation	T _c =25°C	50	W
P _{in}	Input Power	Z _g =Z _l =50Ω	1.5	W
I _D	Drain Current	-	3	A
T _{ch}	Junction Temperature	-	150	°C
T _{stg}	Storage temperature	-	-40 to +125	°C
R _{th j-c}	Thermal resistance	Junction to case	2.5	°C/W

Schematic Drawing

Note 1: Above parameters are guaranteed independently.

ELECTRICAL CHARACTERISTICS (T_c=25°C, UNLESS OTHERWISE NOTED)

SYMBOL	PARAMETER	CONDITIONS	LIMITS			UNIT
			MIN	TYP	MAX.	
I _{DSS}	Zero gate voltage drain current	V _{DS} =17V, V _{GS} =0V	-	-	200	μA
I _{GSS}	Gate to source leak current	V _{GS} =10V, V _{DS} =0V	-	-	1	μA
V _{TH}	Gate threshold Voltage	V _{DS} =12V, I _{DS} =1mA	1.4	1.7	2.4	V
P _{out1}	Output power	f=175MHz, V _{DD} =7.2V	7	8	-	W
η _{D1}	Drain efficiency	P _{in} =0.3W, I _{dq} =700mA	55	60	-	%
P _{out2}	Output power	f=520MHz, V _{DD} =7.2V	7	8	-	W
η _{D2}	Drain efficiency	P _{in} =0.7W, I _{dq} =750mA	50	55	-	%
	Load VSWR tolerance	V _{DD} =9.2V, P _o =7W(Pin Control) f=175MHz, I _{dq} =700mA, Z _g =50Ω Load VSWR=20:1(All Phase)	No destroy			-
	Load VSWR tolerance	V _{DD} =9.2V, P _o =7W(Pin Control) f=520MHz, I _{dq} =750mA, Z _g =50Ω Load VSWR=20:1(All Phase)	No destroy			-

Note : Above parameters , ratings , limits and conditions are subject to change.

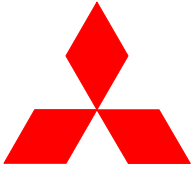

ELECTROSTATIC SENSITIVE DEVICE
OBSERVE HANDLING PRECAUTIONS

MITSUBISHI RF POWER MOS FET

RD07MVS2

RoHS Compliance, Silicon MOSFET Power Transistor, 175MHz, 520MHz, 7W

TYPICAL CHARACTERISTICS

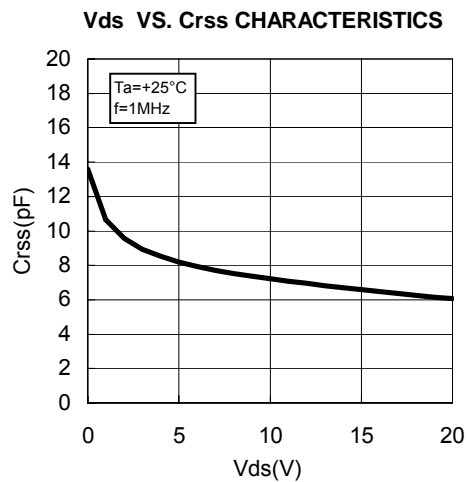
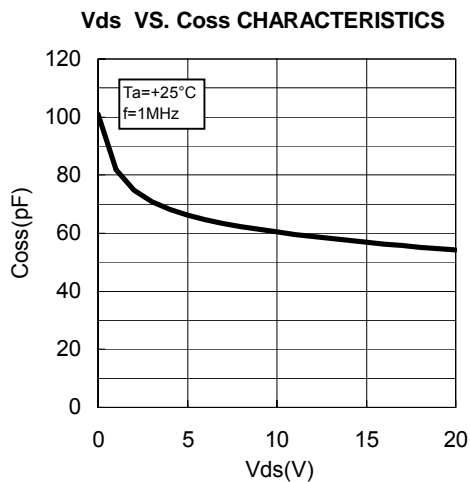
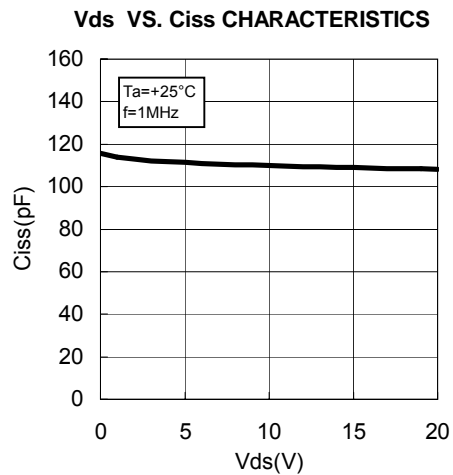
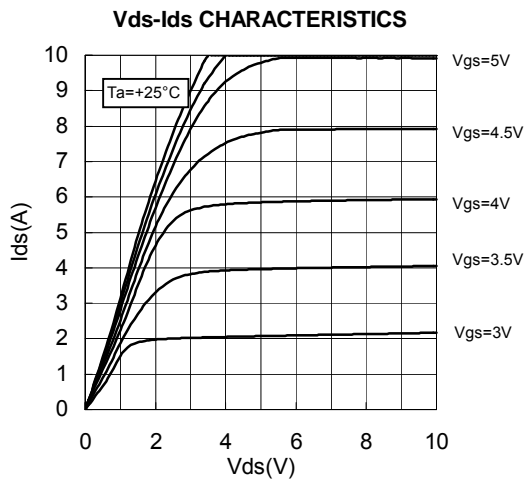
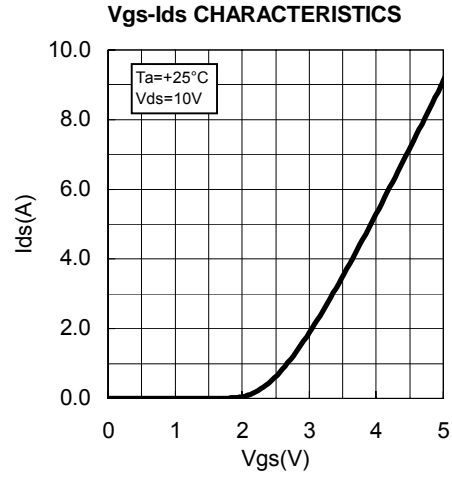
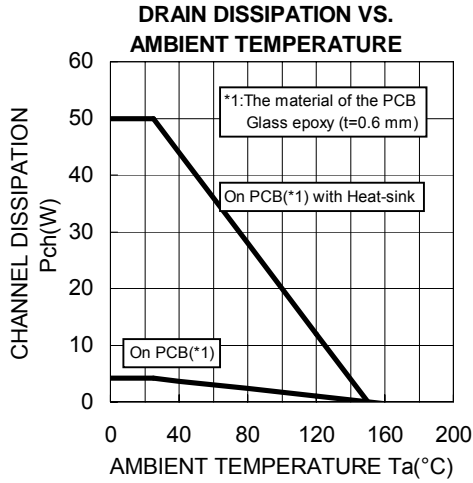

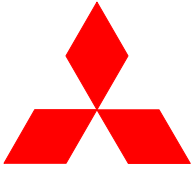

ELECTROSTATIC SENSITIVE DEVICE
OBSERVE HANDLING PRECAUTIONS

MITSUBISHI RF POWER MOS FET

RD07MVS2

RoHS Compliance, Silicon MOSFET Power Transistor, 175MHz, 520MHz, 7W

TYPICAL CHARACTERISTICS

Pin-Po CHARACTERISTICS @f=175MHz

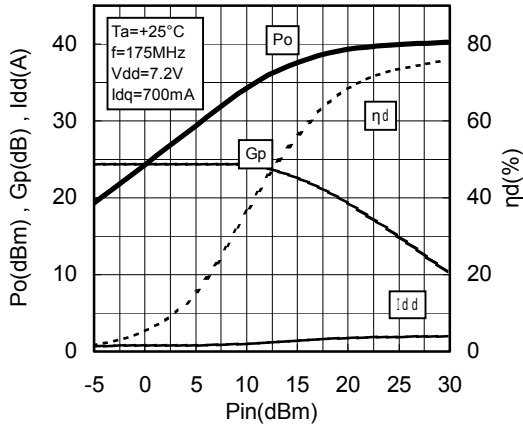

Pin-Po CHARACTERISTICS @f=175MHz

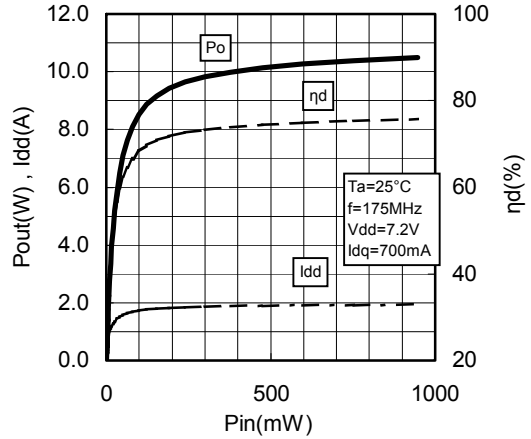

Pin-Po CHARACTERISTICS @f=520MHz

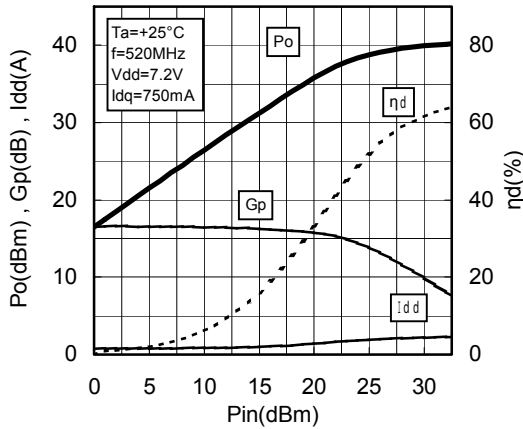

Pin-Po CHARACTERISTICS @f=520MHz

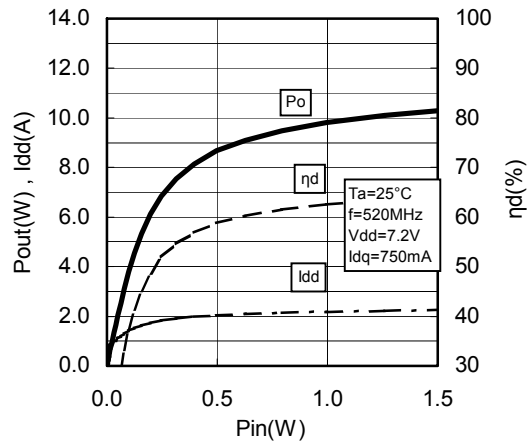

Vdd-Po CHARACTERISTICS @f=175MHz

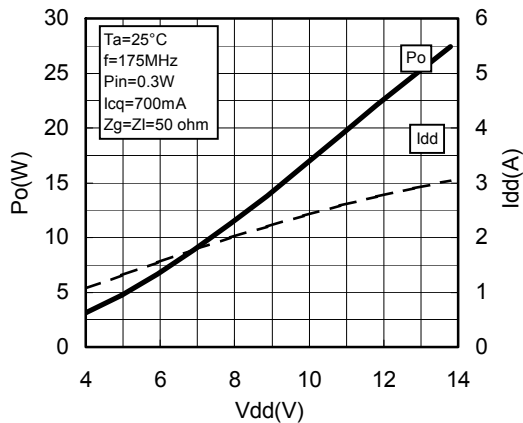

Vdd-Po CHARACTERISTICS @f=520MHz

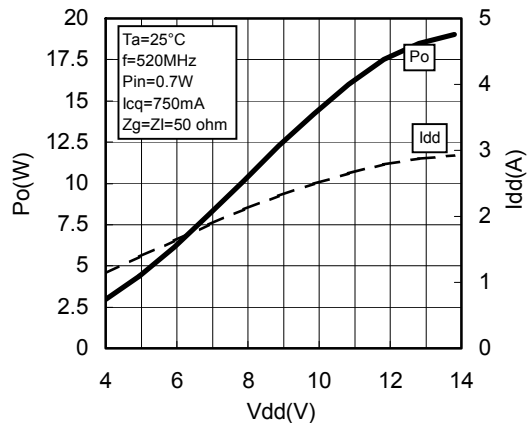

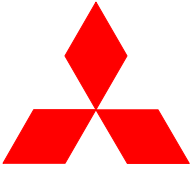

ELECTROSTATIC SENSITIVE DEVICE
OBSERVE HANDLING PRECAUTIONS

MITSUBISHI RF POWER MOS FET RD07MVS2

RoHS Compliance, Silicon MOSFET Power Transistor, 175MHz, 520MHz, 7W

TYPICAL CHARACTERISTICS

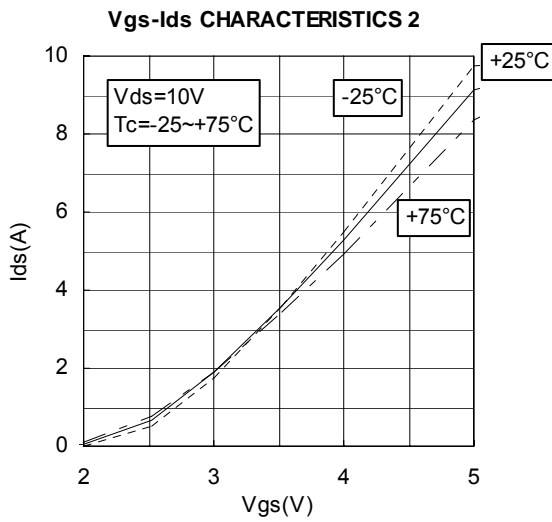



ELECTROSTATIC SENSITIVE DEVICE
OBSERVE HANDLING PRECAUTIONS

MITSUBISHI RF POWER MOS FET

RD07MVS2

RoHS Compliance, Silicon MOSFET Power Transistor, 175MHz, 520MHz, 7W

TEST CIRCUIT(f=175MHz)

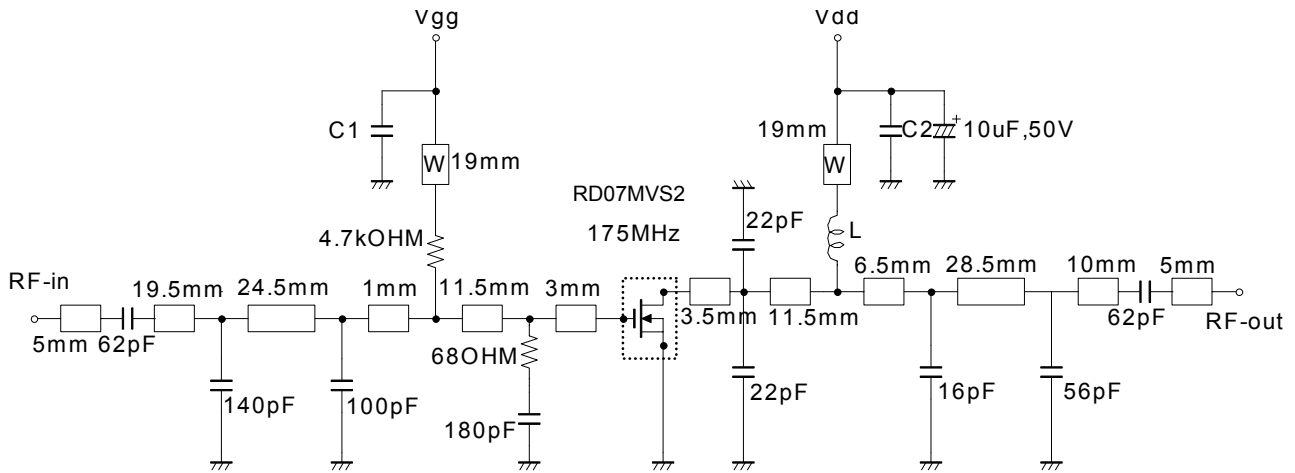

L: Enameled wire 7Turns, D:0.43mm, 2.46mm O.D

C1, C2: 1000pF, 0.022uF in parallel

Note: Board material- Teflon substrate

Micro strip line width=2.2mm/50OHM, er:2.7, t=0.8mm

W: line width=1.0mm

TEST CIRCUIT(f=520MHz)

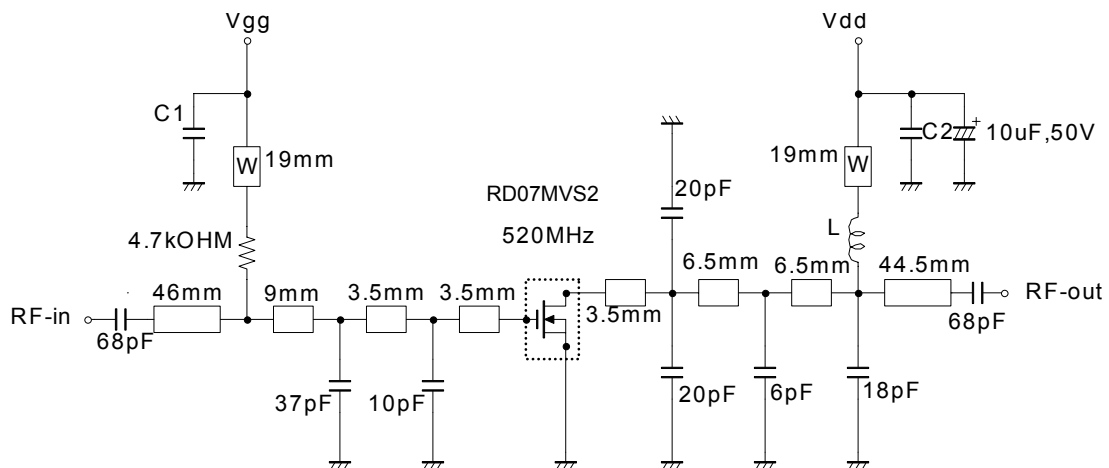

L: Enameled wire 5Turns, D:0.43mm, 2.46mm O.D

C1, C2: 1000pF, 0.022uF in parallel

Note: Board material- Teflon substrate

Micro strip line width=2.2mm/50OHM, er:2.7, t=0.8mm

W: line width=1.0mm



ELECTROSTATIC SENSITIVE DEVICE
OBSERVE HANDLING PRECAUTIONS

MITSUBISHI RF POWER MOS FET

RD07MVS2

RoHS Compliance, Silicon MOSFET Power Transistor, 175MHz, 520MHz, 7W

INPUT/OUTPUT IMPEDANCE VS. FREQUENCY CHARACTERISTICS

175MHz Z_{in}^* Z_{out}^*
 $Z_o=10\Omega$

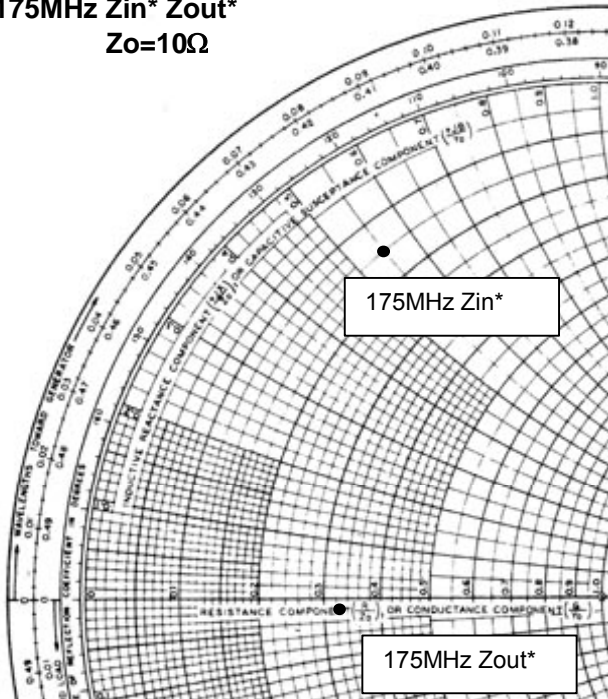

$V_{dd}=7.2V$, $I_{dq}=700mA$ (V_{gg} adj.), $P_{in}=0.28W$

$Z_{in}^*=1.55+j5.53$
 $Z_{out}^*=3.24-j0.26$

Z_{in}^* : Complex conjugate of input impedance
 Z_{out}^* : Complex conjugate of input impedance

520MHz Z_{in}^* Z_{out}^*
 $Z_o=10\Omega$

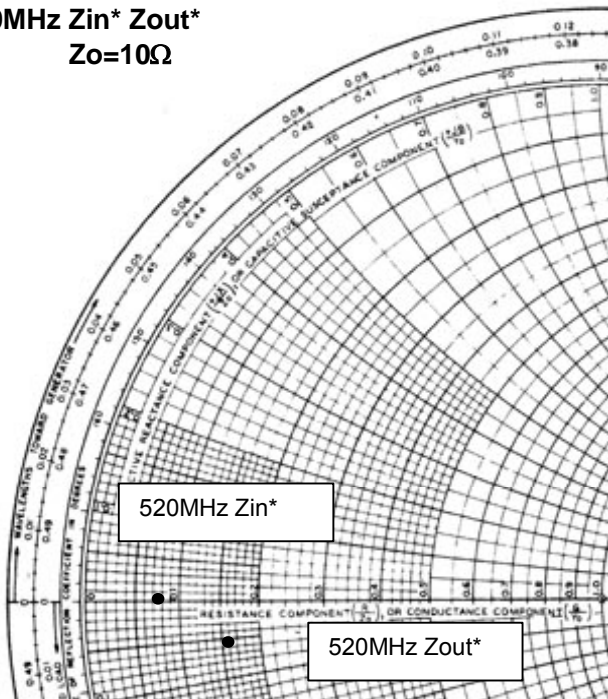

$V_{dd}=7.2V$, $I_{dq}=750mA$ (V_{gg} adj.), $P_{in}=0.7W$

$Z_{in}^*=0.76+j0.06$
 $Z_{out}^*=1.61-j0.52$

Z_{in}^* : Complex conjugate of input impedance
 Z_{out}^* : Complex conjugate of input impedance



ELECTROSTATIC SENSITIVE DEVICE
OBSERVE HANDLING PRECAUTIONS

MITSUBISHI RF POWER MOS FET

RD07MVS2

RoHS Compliance, Silicon MOSFET Power Transistor, 175MHz, 520MHz, 7W

RD07MSV2 S-PARAMETER DATA (@Vdd=7.2V, Id=750mA)

Freq. [MHz]	S11		S21		S12		S22	
	(mag)	(ang)	(mag)	(ang)	(mag)	(ang)	(mag)	(ang)
100	0.899	-175.3	5.567	79.3	0.015	-9.4	0.792	-173.5
150	0.903	-177.2	3.576	71.1	0.015	-17.0	0.790	-175.1
175	0.903	-177.7	3.002	68.3	0.014	-18.8	0.799	-174.8
200	0.909	-178.4	2.602	65.1	0.015	-22.7	0.823	-174.7
250	0.911	-179.0	1.987	58.3	0.014	-28.8	0.829	-175.4
300	0.919	-179.6	1.585	53.4	0.012	-32.8	0.842	-175.7
350	0.923	-179.7	1.291	47.9	0.012	-37.7	0.866	-176.3
400	0.927	-178.9	1.062	43.4	0.011	-39.8	0.864	-176.5
450	0.931	-178.5	0.902	39.1	0.010	-38.9	0.887	-177.3
500	0.934	-177.8	0.749	35.7	0.009	-40.4	0.896	-177.8
520	0.939	-177.6	0.715	33.6	0.008	-43.4	0.895	-177.8
550	0.940	-177.3	0.656	31.6	0.008	-41.3	0.901	-178.3
600	0.942	-176.8	0.576	29.9	0.007	-52.0	0.916	-179.4
650	0.944	-176.2	0.502	26.0	0.007	-45.6	0.914	-179.4
700	0.948	-175.6	0.437	24.4	0.006	-52.8	0.925	-179.7
750	0.948	-175.4	0.393	21.7	0.004	-58.3	0.929	-179.3
800	0.950	-174.7	0.344	18.8	0.005	-53.1	0.927	-178.9
850	0.953	-174.3	0.303	17.0	0.004	-51.4	0.937	-178.2
900	0.951	-174.1	0.279	15.1	0.003	-52.0	0.931	-178.2
950	0.954	-173.5	0.243	12.6	0.003	-40.6	0.937	-177.4
1000	0.954	-173.2	0.236	10.9	0.002	-21.3	0.942	-177.4
1050	0.956	-172.9	0.201	12.4	0.001	-44.2	0.941	-177.2
1100	0.956	-172.7	0.193	9.8	0.002	-13.4	0.943	-176.7

RD07MSV2 S-PARAMETER DATA (@Vdd=12.5V, Id=750mA)

Freq. [MHz]	S11		S21		S12		S22	
	(mag)	(ang)	(mag)	(ang)	(mag)	(ang)	(mag)	(ang)
100	0.897	-173.6	5.995	78.6	0.016	-8.7	0.763	-172.0
150	0.899	-176.0	3.832	69.8	0.016	-15.9	0.764	-173.3
175	0.904	-176.8	3.224	66.6	0.016	-21.2	0.778	-173.5
200	0.906	-177.3	2.776	62.8	0.015	-22.5	0.800	-173.2
250	0.910	-178.3	2.100	56.4	0.013	-28.7	0.813	-173.2
300	0.919	-179.0	1.662	50.8	0.013	-30.5	0.826	-174.1
350	0.926	-179.9	1.356	45.0	0.011	-37.5	0.853	-174.6
400	0.929	-179.3	1.107	40.4	0.011	-44.2	0.860	-175.0
450	0.936	-178.6	0.925	36.5	0.010	-44.4	0.879	-175.9
500	0.937	-177.9	0.788	31.8	0.009	-49.0	0.891	-176.5
520	0.939	-177.6	0.732	30.8	0.008	-52.4	0.893	-176.6
550	0.943	-177.2	0.668	28.9	0.008	-55.9	0.897	-177.3
600	0.942	-176.6	0.582	26.1	0.006	-51.8	0.911	-178.1
650	0.947	-176.0	0.505	22.2	0.006	-59.2	0.913	-178.6
700	0.949	-175.5	0.444	20.9	0.005	-52.6	0.922	-179.3
750	0.949	-175.1	0.380	17.8	0.005	-58.1	0.923	-179.8
800	0.951	-174.4	0.347	14.6	0.003	-50.6	0.929	-179.9
850	0.955	-174.0	0.314	15.7	0.003	-51.6	0.934	-179.1
900	0.956	-173.7	0.283	11.8	0.003	-80.2	0.934	-179.0
950	0.953	-173.1	0.252	11.8	0.002	-53.3	0.939	-178.1
1000	0.955	-172.8	0.234	7.8	0.003	-67.0	0.943	-178.0
1050	0.956	-172.5	0.212	8.5	0.002	-30.6	0.940	-177.8
1100	0.955	-172.1	0.187	4.0	0.001	15.8	0.943	-177.2

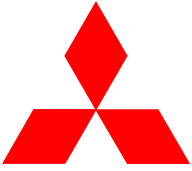

ELECTROSTATIC SENSITIVE DEVICE
OBSERVE HANDLING PRECAUTIONS

MITSUBISHI RF POWER MOS FET

RD07MVS2

RoHS Compliance, Silicon MOSFET Power Transistor, 175MHz, 520MHz, 7W

— Keep safety first in your circuit designs! —

Mitsubishi Electric Corporation puts the maximum effort into making semiconductor products better and more reliable, but there is always the possibility that trouble may occur with them. Trouble with semiconductors may lead to personal injury, fire or property damage. Remember to give due consideration to safety when making your circuit designs, with appropriate measures such as (i) placement of substitutive, auxiliary circuits, (ii) use of non-flammable material or (iii) prevention against any malfunction or mishap.

warning !

Do not use the device at the exceeded the maximum rating condition. In case of plastic molded devices, the exceeded maximum rating condition may cause blowout, smoldering or catch fire of the molding resin due to extreme short current flow between the drain and the source of the device. These results causes in fire or injury.