

Product Description:

The TQM7136 is a 3V, 2 stage SiGe HBT Power Amplifier Module designed for use in mobile phones. Its RF performance meets the requirements for products designed to IS-95/98 standards. The quiescent current of the TQM7136 is set by the base-band processor using two CMOS compatible I_{CO} control voltages (V_{CTRL1} and V_{CTRL2}). Overall current consumption of the device is minimized by selecting the lowest I_{CO} state available for each power output level. RF input and output matching is included within the module; therefore, minimal external circuitry is required.

The TQM7136 gives excellent RF performance with low current consumption resulting in longer talk times in portable applications. The small 6mm square surface mount package is ideal for new generation small and light phones.

Electrical Specifications:

Parameter	Min	Typ	Max	Units
Frequency	824		849	MHz
CDMA mode Pout ¹		28		dBm
CDMA Mode Efficiency ¹		36		%
AMPS Mode Output Power ²		31.5		dBm
AMPS Mode Efficiency ²		51		%

Note 1: Test Conditions CDMA Mode: $V_{CC1}=3.4VDC$, $V_{CC2}=3.4VDC$, $V_{REF}=2.85VDC$, $V_{CTRL1}=1.7VDC$, $V_{CTRL2}=1.7VDC$, $T_C=25^{\circ}C$, $P_{out} = 28.0dBm$

Note 2: Test Conditions AMPS Mode: $V_{CC1}=3.4VDC$, $V_{CC2}=3.4VDC$, $V_{REF}=2.85VDC$, $V_{CTRL1}=1.7VDC$, $V_{CTRL2}=1.7VDC$, $T_C=25^{\circ}C$, $P_{out}=31.5dBm$

TQM7136

DATA SHEET

**3V HBT SiGe CDMA POWER
AMPLIFIER MODULE**

Features

- High Efficiency
- Three quiescent current states
- CMOS compatible logic inputs
- Excellent ACP and ALT
- Small 8 pin 6x6mm module
- Internally matched input and output
- Full ESD Protection
- Low leakage current

Applications

- Cellular Band CDMA IS-95/98 based mobile phones.
- Single-Mode, Dual Mode, and Tri Mode CDMA/AMPS phones

TQM7136 - Preliminary Data Sheet

Absolute Maximum Ratings

Symbol	Parameter	Absolute Maximum Value	Units
V_{CC1}, V_{CC2}	Power Supply Voltage, no RF Applied RF Applied	-0.5 to 6.0 -0.5 to 5.0	VDC
$V_{REF}, V_{CTRL1},$ and V_{CTRL2}	Bias reference voltages (V_{REF}) and bias control voltage (V_{CTRL1} and V_{CTRL2}).	-0.5 to 5.0	VDC
P_{DISS}	Power Dissipation	2.5	W
T_C	Case Temperature, Survival	-40 to +100	°C
T_{STG}	Storage Temperature	-40 to +150	°C
RF_{IN}	DC Grounded RF input, 50ohm RF impedance	0 to 0V	VDC
RF_{OUT}	DC Blocked RF output, 50 ohm RF impedance	-20V to 20V	VDC

Note: The part may not survive all maximums applied simultaneously.

CDMA Mode Electrical Characteristics^{1,2,3}

Parameter	Conditions	Min.	Typ/Nom	Max.	Units
RF Frequency		824		849	MHz
P_{out}, I_{CO-hi}	$V_{CTRL1}=high, V_{CTRL2}=high$		28		dBm
Large Signal Gain, I_{CO-hi}	$P_{out} = 28dBm, V_{CTRL1}=high, V_{CTRL2}=high$	26	29		dB
Large Signal Gain, I_{CO-mid}	$P_{out} = 12dBm, V_{CTRL1}=high, V_{CTRL2}=low$	25	28		dB
Large Signal Gain, I_{CO-low}	$P_{out} = -0.5dBm, V_{CTRL1}=low, V_{CTRL2}=low$		21		dB
Gain Variation vs. Temp.	-30 to 85 °C, $P_{out}=28dBm$		+/-1.4		dB
Quiescent Current, I_{CO-hi}	$V_{CTRL1}=high, V_{CTRL2}=high$		118	135	mA
Quiescent Current, I_{CO-hi}	$V_{CTRL1}=high, V_{CTRL2}=low$		65	80	mA
Quiescent Current, I_{CO-low}	$V_{CTRL1}=low, V_{CTRL2}=low$		25	35	mA
I_{CC}	$P_{out}=28dBm, V_{CTRL1}=high, V_{CTRL2}=high$		503		mA
Power Added Efficiency	$P_{out} = 28dBm, V_{CTRL1}=high, V_{CTRL2}=high$	33	36		%
Adjacent Channel Power (ACP)	$P_{out} = 28dBm, V_{CTRL1}=high, V_{CTRL2}=high, IS-95$ Standard		-49	-44	dBc
Alternate Channel Power (ALT)	$P_{out} = 28dBm, V_{CTRL1}=high, V_{CTRL2}=high, IS-95$ Standard		-57	-55	dBc
Output Power Mid-Power I_{cq} state	$ACPR=-49dBc, V_{CTRL1}=high, V_{CTRL2}=low, IS-95$ Standard		12		dBm
Output Power Low-Power I_{cq} state	$ACPR=-50dBc, V_{CTRL1}=high, V_{CTRL2}=low, IS-95$ Standard		-0.5		dBm

CDMA Mode Electrical Characteristics^{1,2,3} (cont'd)

Noise Power in Rx band	Pout=28dBm, V _{CTRL1} =high, V _{CTRL2} =high, IS-95 Standard	-94			dBm/30KHz
Input VSWR	Both I _{CO} -hi & I _{CO} -mid	1.6:1			
Second Harmonic	Pout=+28dBm, V _{CTRL1} =high, V _{CTRL2} =high, IS-95 Standard	-35			dBc
Third Harmonic	Pout=+28dBm, V _{CTRL1} =high, V _{CTRL2} =high, IS-95 Standard	-45			dBc
Recommended Supply Voltage		3.1	3.4	4.2	VDC
Reference Voltage		2.8	2.85	2.9	VDC
V _{REF} Current, I _{CO} -hi	Hi-Power Mode, V _{CTRL1} =high, V _{CTRL2} =high	10			mA
V _{REF} Current, I _{CO} -mid	Mid-Power Mode, V _{CTRL1} =high, V _{CTRL2} =low	5			mA
V _{REF} Current, I _{CO} -lo	Mid-Power Mode, V _{CTRL1} =low, V _{CTRL2} =low	2			mA
Leakage Current	V _{CTRL1} =low, V _{CTRL2} =low, V _{REF} =0VDC	10			μA
Logic Current (V _{CTRL1} , V _{CTRL2})				100	μA
Logic Voltage (V _{CTRL1} , V _{CTRL2})	High	1.7	2.0	4.5	VDC
	Low	0	0.25	0.5	VDC
Recommended Operating Temperature		-30		+85C	
Ruggedness	No Damage, Pout=+28dBm, V _{CTRL1} =high, V _{CTRL2} =high, IS-95 Standard			10:1	
Stability	No Oscillations, Pout=+28dBm, V _{CTRL1} =high, V _{CTRL2} =high, IS-95 Standard			10:1	

Note 1: Test Conditions: V_{CC1}=3.4VDC, V_{CC2}=3.4VDC, V_{REF}=2.85VDC, V_{CTRL1}=2.00VDC, V_{CTRL2}=2.00VDC, RF=836 MHz, T_C = 25°C unless otherwise specified.

Note 2: Min./Max. limits are at +25°C case temperature unless otherwise specified.

Note 3: TriQuint Test Board.

AMPS Mode Electrical Characteristics^{1,2,3}

Parameter	Conditions	Min.	Typ/Nom	Max.	Units
RF Frequency		824		849	MHz
Pout, Saturated	Pin = +3.5dBm		31.5		dBm
Large Signal Gain	Pout = 31.5 dBm, Pin=3.5dBm	24.5	27		dB
Power Added Efficiency	Pout = 31.5 dBm, Pin=3.5dBm	47	51		%
Receive Band Noise Power	BW=30KHz, f=Tx+45MHz		-93		dBm/30KHz
Input VSWR	All Operating Pout and Vcc		1.6:1		

TQM7136 - Preliminary Data Sheet

AMPS Mode Electrical Characteristics^{1,2,3} (cont'd)

2 nd Harmonic	Pout = 31.5 dBm	-32.5	dBc
3 rd Harmonic	Pout = 31.5 dBm	-42.5	dBc
Icc	Pout = 31.5 dBm	783	mA

Note 1: Test Conditions: $V_{CC1}=3.4VDC$, $V_{CC2}=3.4VDC$, $V_{REF}=2.85$, $V_{CTRL1}=1.7VDC$, $V_{CTRL2}=1.7VDC$, $RF=836MHz$, $T_C = 25^{\circ}C$ unless otherwise specified.

Note 2: Min./Max. limits are at +25°C case temperature unless otherwise specified.

Note 3: TriQuint Test Board.

Typical Performance, CDMA High Power Mode:

Test Conditions (Unless Otherwise Specified): $V_{CC1}=3.4VDC$, $V_{CC2}=3.4VDC$, $V_{CTRL1}=1.7VDC$, $V_{CTRL2}=1.7VDC$, $V_{REF}=2.85VDC$, $P_{OUT}=28.0dBm$, $T_C=+25^{\circ}C$.

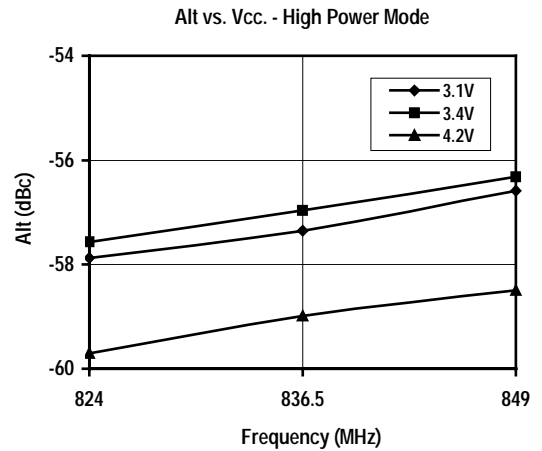
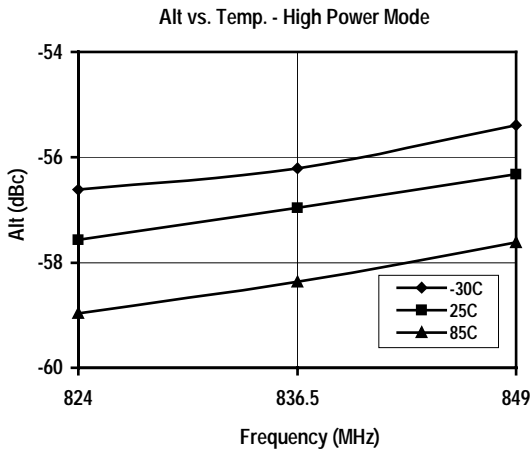
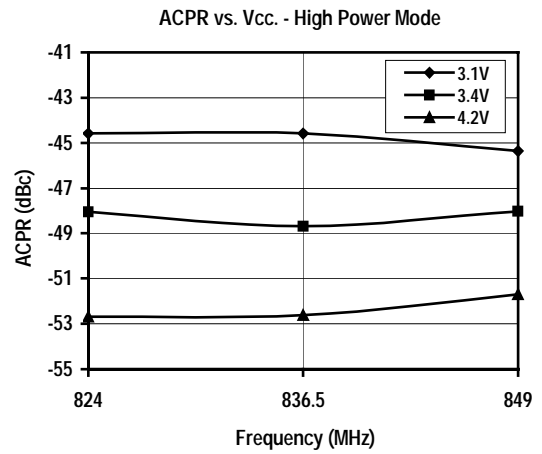
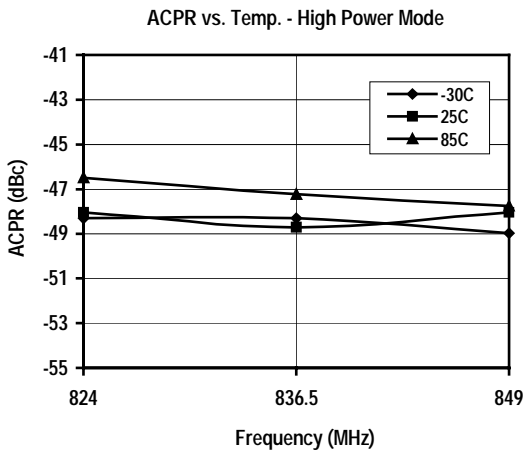
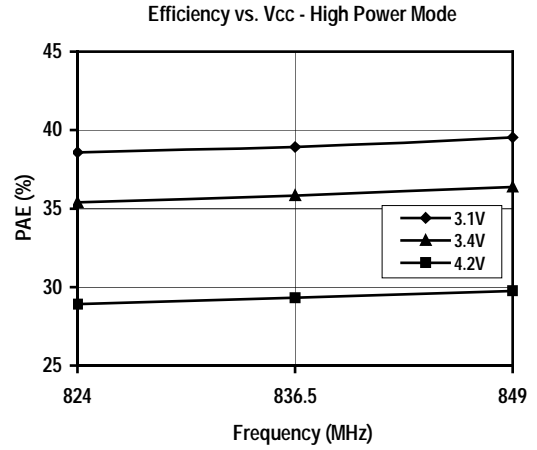
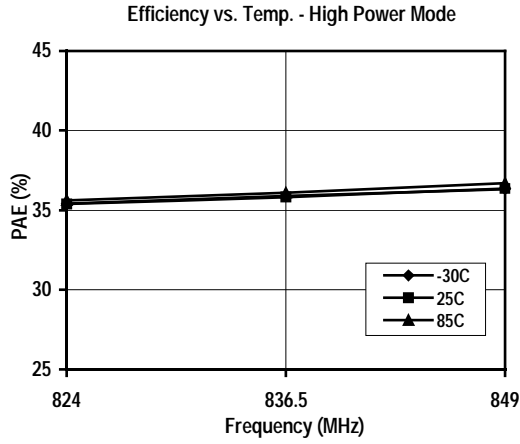

TQM7136-Preliminary Data Sheet

Typical Performance, CDMA High Power Mode (cont'd):

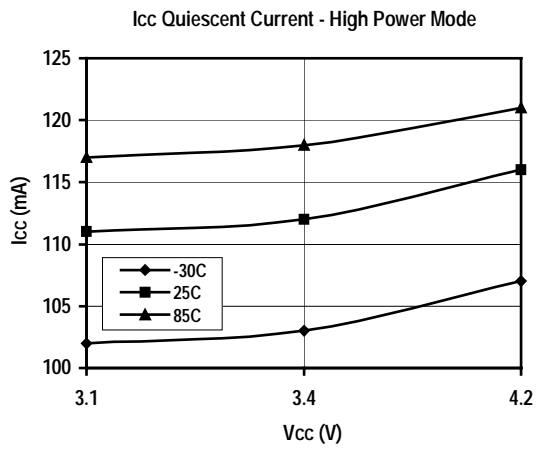
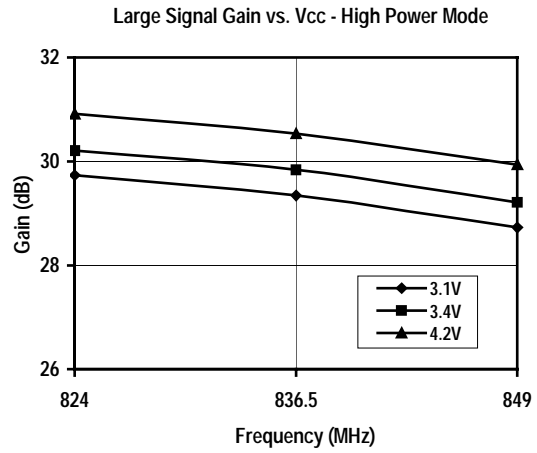
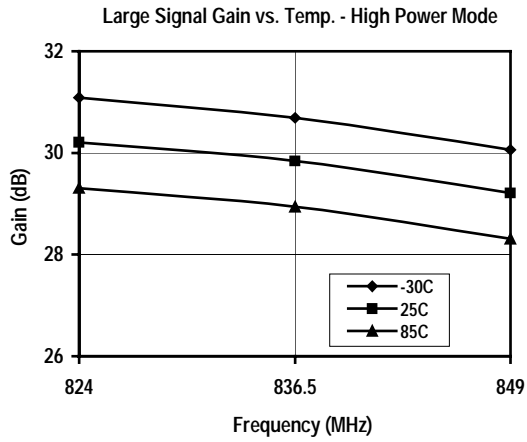

Typical Performance, CDMA Mid Power Mode:

Test Conditions (Unless Otherwise Specified): $V_{CC1}=3.4VDC$, $V_{CC2}=3.4VDC$, $V_{CTRL1}=1.7VDC$, $V_{CTRL2}=0.5VDC$, $V_{REF}=2.85VDC$, $P_{OUT}=12.0dBm$, $T_C=+25^{\circ}C$.

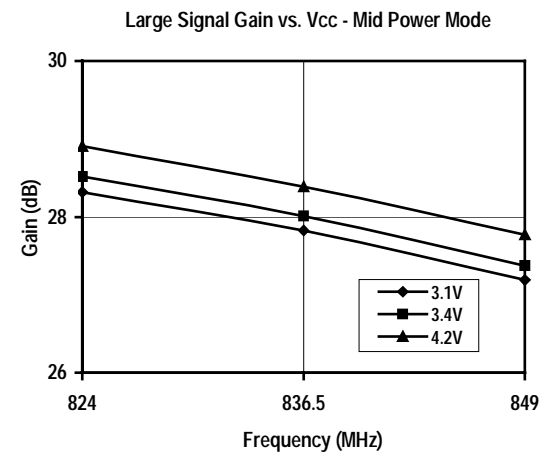
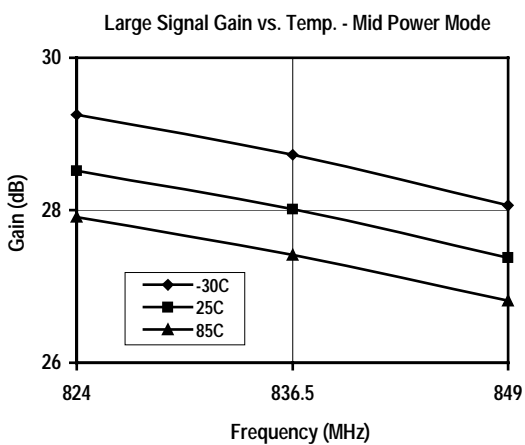
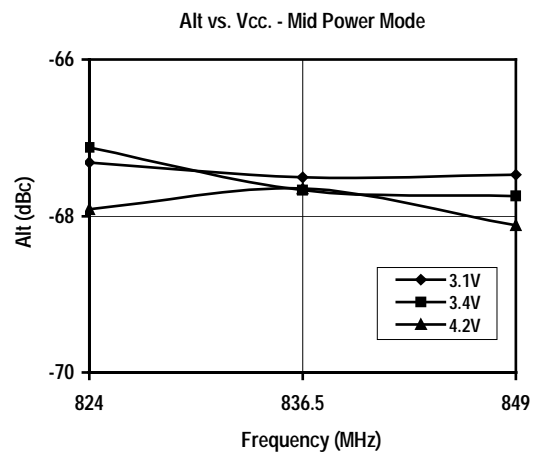
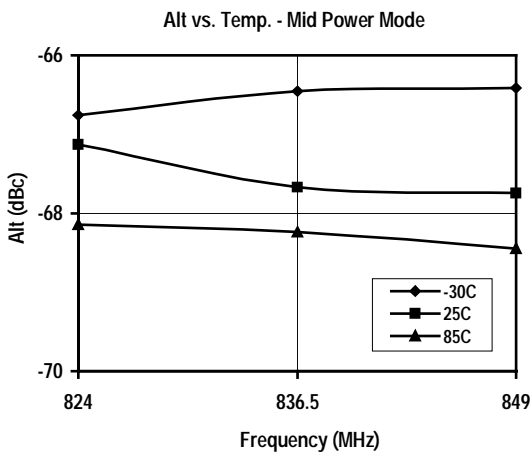
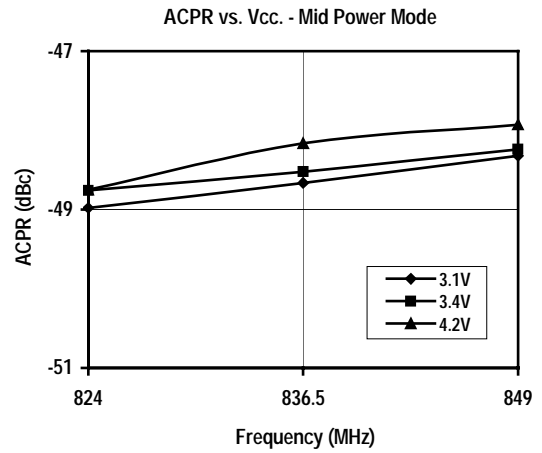
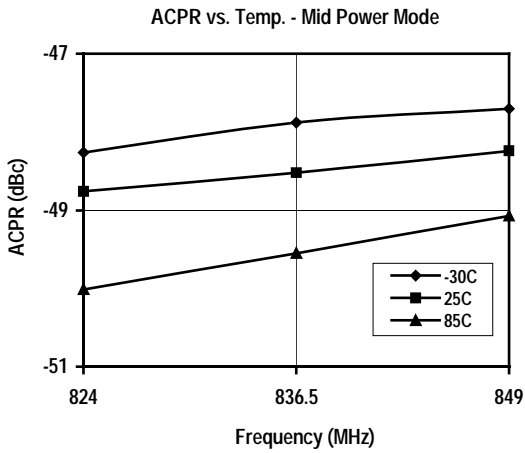

TQM7136-Preliminary Data Sheet

Typical Performance, CDMA Mid Power Mode (cont'd):

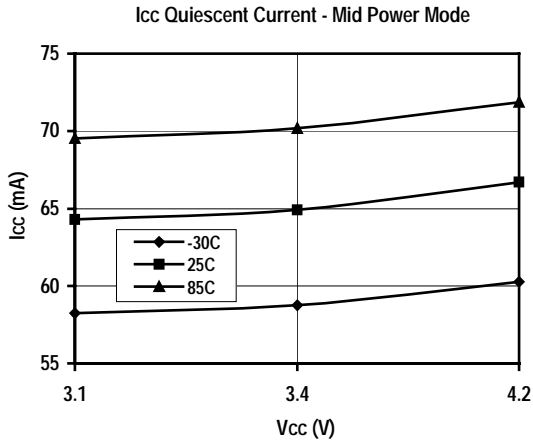

Typical Performance, CDMA Low Power Mode:

Test Conditions (Unless Otherwise Specified): $V_{CC1}=3.4VDC$, $V_{CC2}=3.4VDC$, $V_{CTRL1}=0.5VDC$, $V_{CTRL2}=0.5VDC$, $V_{REF}=2.85VDC$, $P_{OUT}=-0.5dBm$, $T_C=+25^{\circ}C$.

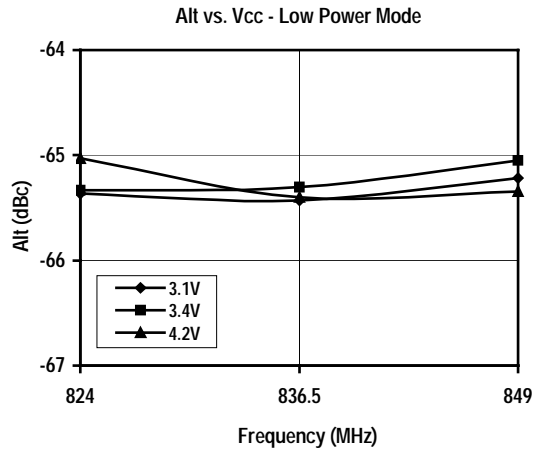
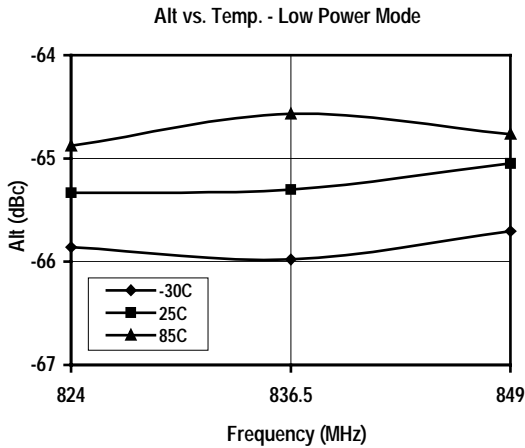
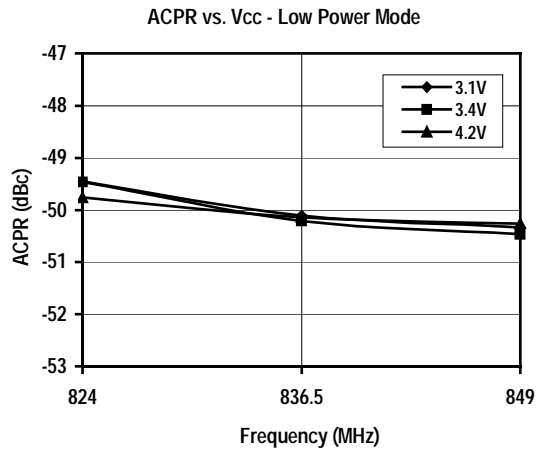
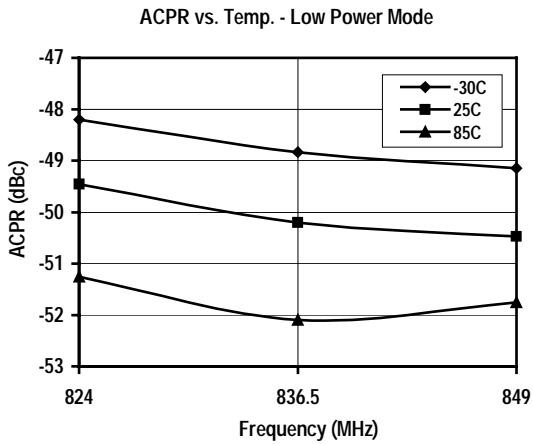

Typical Performance, CDMA Low Power Mode (cont'd):

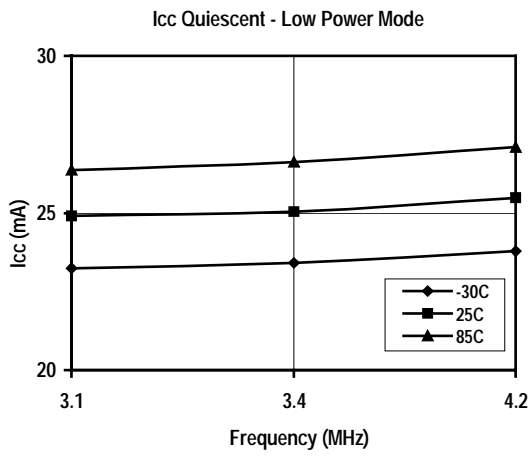
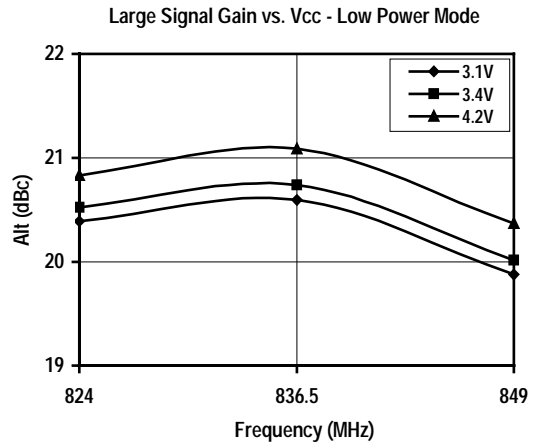
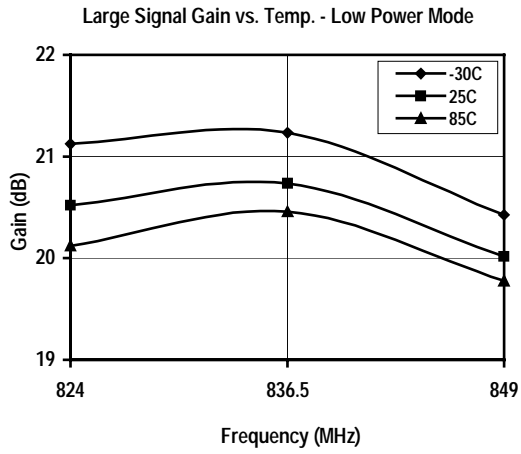

TQM7136-Preliminary Data Sheet

Typical Performance, AMPS Mode:

Test Conditions (Unless Otherwise Specified): $V_{CC1}=3.4VDC$, $V_{CC2}=3.4VDC$, $V_{CTRL1}=1.7VDC$, $V_{CTRL2}=1.7VDC$, $V_{REF}=2.85VDC$, $P_{in}=5dBm$, $T_C=+25^{\circ}C$.

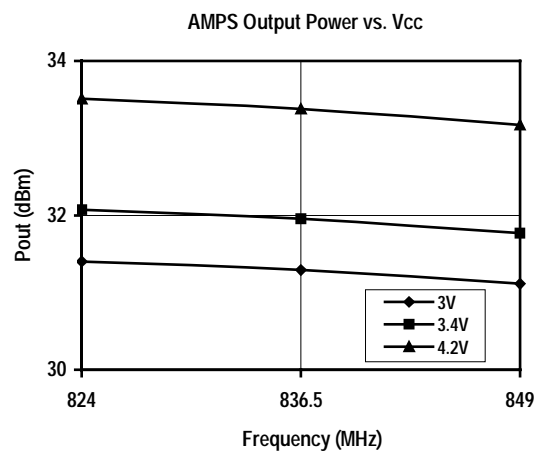
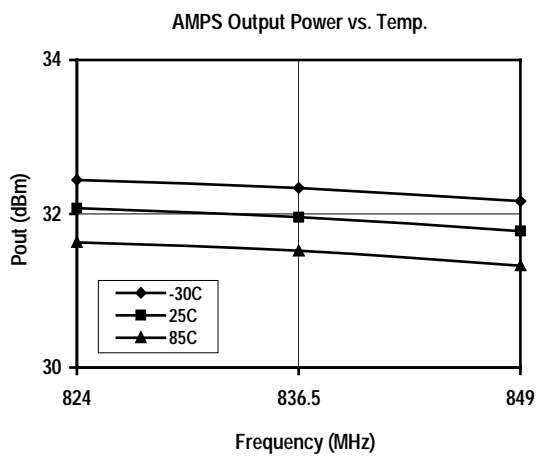
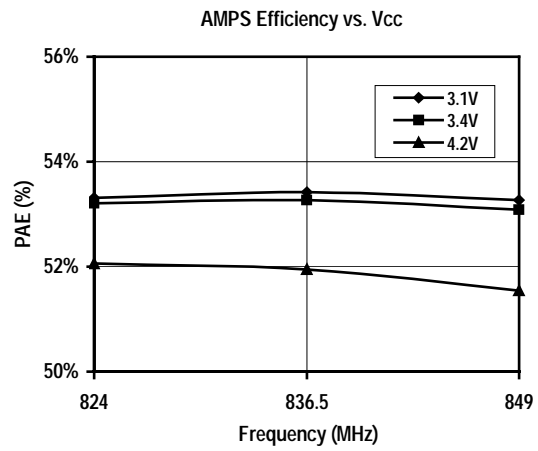
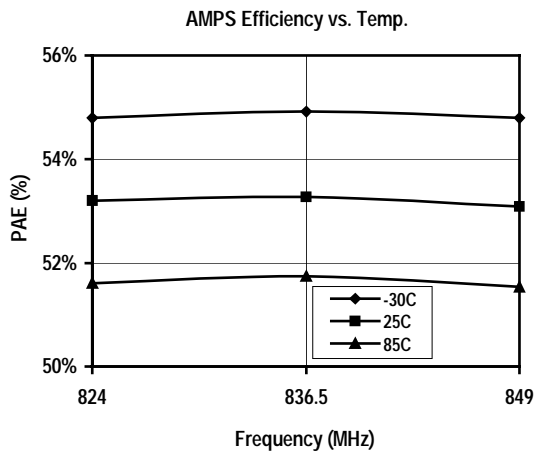

Application/Test Circuit:

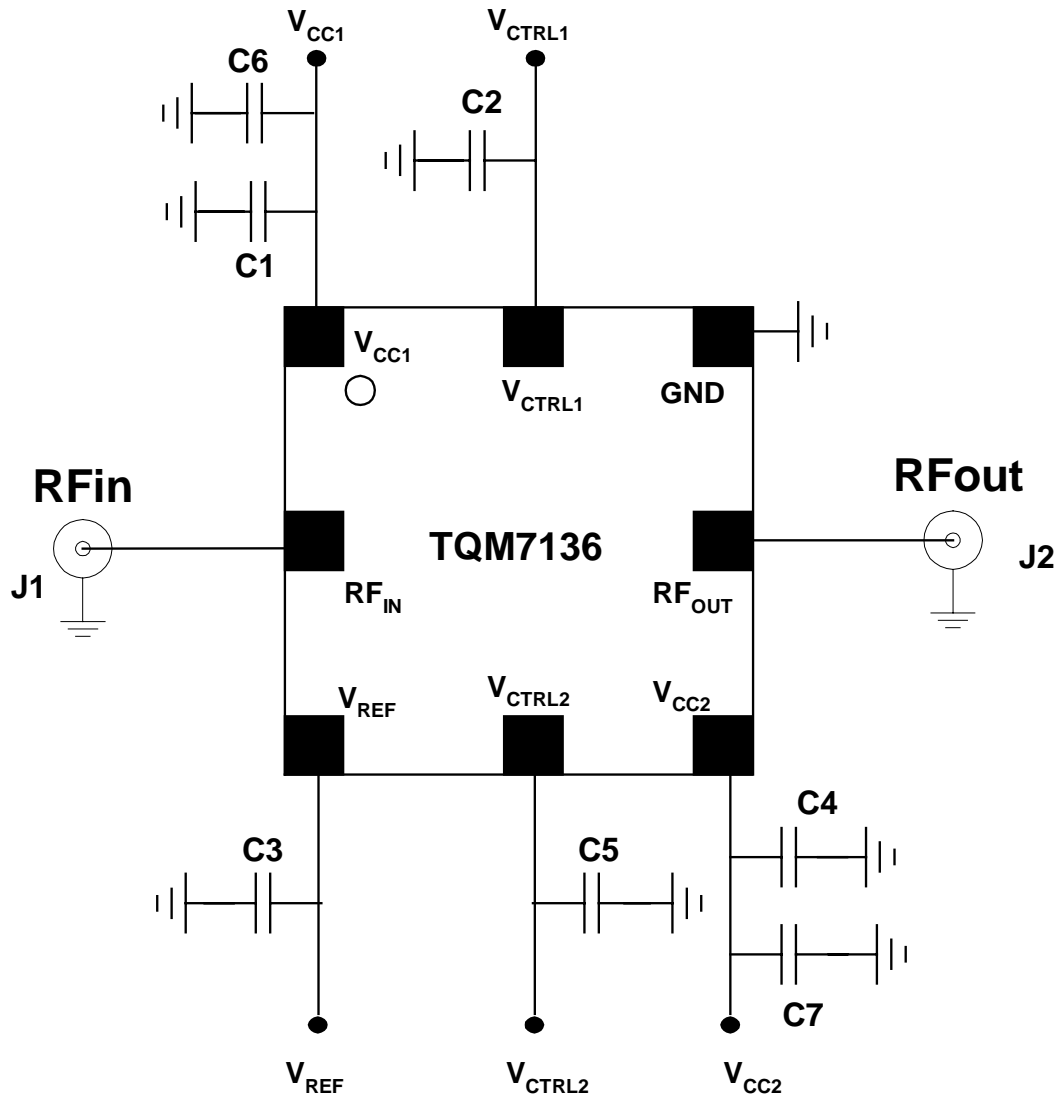

US Cellular Band, 824 – 849 MHz

*Bill of Material for TQM7136 Power Amplifier Module Application/Test Circuit**

Component	Reference Designator	Part Number	Value, Cellular Band	Size
Power Amplifier Module		TQM7136		8pin/6mm square
RF Connector	J1, J2			
Capacitor	C1, C2, C3, C4, C5		0.1µF	0402
Capacitor	C6, C7		10µF	1210

*May vary due to printed circuit board layout and material

TQM7136-Preliminary Data Sheet

Product Description:

The TQM71356 is a two stage SiGe HBT power amplifier module in a cascade configuration intended for use in CDMA Cellular band handsets.

Operation

The operation modes of the TQM7136 are determined based on the setting of V_{CNTRL1} , V_{CNTRL2} , and V_{REF} . The truth table below defines the operating mode. In addition, please refer to the test circuit above and the section on determining the input and output matching circuits below. V_{CNTRL1} and V_{CNTRL2} must be set to low with V_{REF} is low (<0.7VDC) to prevent forward biasing the ESD diodes between V_{REF} and the control lines (V_{CNTRL1} and V_{CNTRL2}).

Operating Mode	V_{CNTRL1}	V_{CNTRL2}	V_{REF}
High Power	High	High	>2.7VDC
Mid Power	High	Low	>2.7VDC
Low Power	Low	Low	>2.7VDC
Off	Low	Low	0VDC

Application

The applications circuit for the TQM7136 is very simple since most of the critical components are included inside the module. There are several important considerations when using the module in a phone design.

First of all, it is important that the source impedance of the V_{CC} power supply be very low. This is because the high current demand during the modulation peaks of the CDMA waveform can introduce voltage ripple at the symbol rate that will introduce additional inter-modulation distortion or Adjacent Channel Power

distortion at the output of the power amplifier. If the power amplifier has a quiescent current of 100 mA and a peak current demand in excess of 1 amp, it is possible to see 900 mA change in the current required from V_{CC} as the modulated signal moves from one extreme to the other. If the power supply source impedance were 1 ohm, the resulting voltage ripple would be 0.9 volts which would cause the amplifier to fail its ACP requirements. Generally, the power supply source impedance should be kept as low as possible, preferably below 0.1 ohms total. Most battery technologies used in cellular telephones will support a low source impedance, but it may be necessary to supplement this in some designs with a low ESR capacitor. Ceramic or tantalum capacitors of approximately 10 micro-farads work well for this requirement.

The application circuit includes 0.1 μ F capacitors at each of the PA control lines and V_{CC} lines to ensure proper RF bypassing. Depending on the phone board layout and circuit bypassing in other areas of the phone, some of these components may not be necessary. There are a number of VCO signals and IF signals used in a given phone design, so it is important to protect the PA module from interfering signals and to limit any interference coming from the PA itself. Care should be taken when removing any of the RF bypassing components.

One final area of concern is with excessive bypassing. If too large a value of bypassing capacitor is used on any of the control lines, it could reduce the frequency response of that control line to the point where a specification failure could occur. Please be sure that the logic lines and regulated supply lines driving the power amplifier control lines are adequate to supply peak current requirements of the bypassing capacitors chosen on the control lines.

Package Pinout:

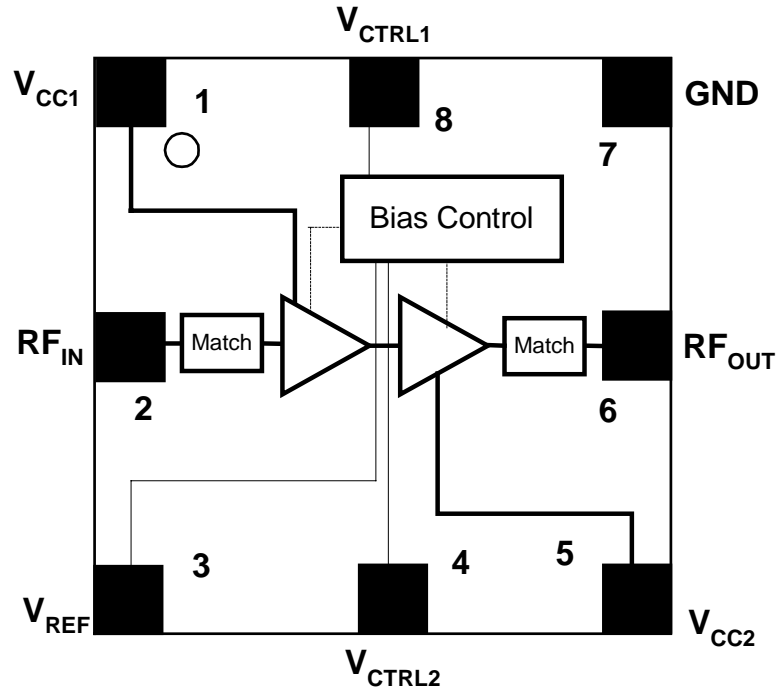

Pin Descriptions:

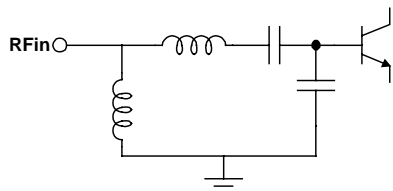
Pin Name	Pin #	Description and Usage (Equivalent Circuit)
GND	Paddle	Device Ground and Heat Sink. Needs good thermal path to remove heat.
V _{CC1}	1	Collector supply for input stage.
RF _{IN}	2	RF input. The RF circuit is DC grounded. 50 Ohm RF impedance. 
V _{REF}	3	Regulated supply for setting bias. Vref is set to 0VDC to power-off the TQM7136
V _{CTRL2}	4	CMOS compatible logic level to set bias level
V _{CC2}	5	Collector supply for output stage.
RF _{OUT}	6	RF output. The RF circuit is DC blocked internally. 50 ohm RF impedance.
GND	7	Ground
V _{CTRL1}	8	CMOS compatible logic level to set bias level.

TriQuint recommends use of several via holes to the backside ground under the Paddle.

TOM7136-Preliminary Data Sheet

Recommended PC board layout to Accept 8 Pin Module Package:

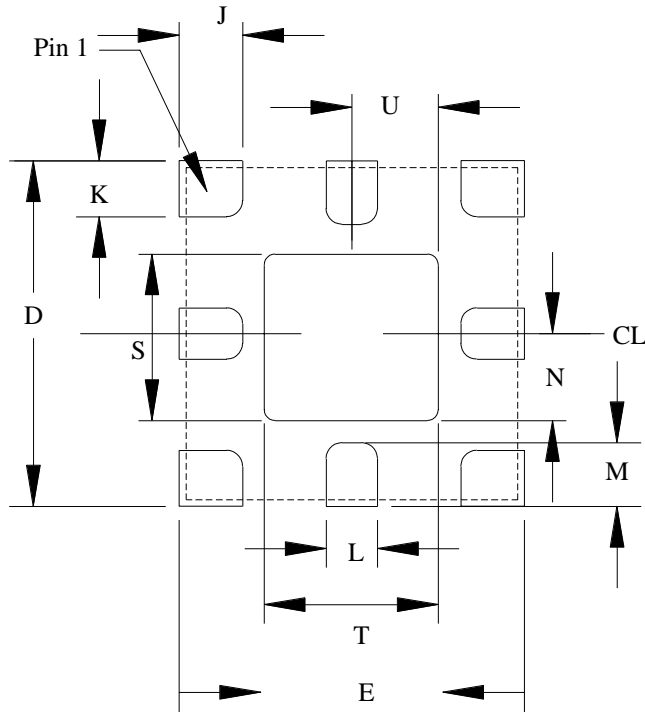

Dimension	mm	in
D	6.35	0.250
E	6.35	0.250
J	1.17	0.046
K	1.03	0.040
L	0.95	0.037
M	1.17	0.046
N	1.60	0.063
S	3.06	0.120
T	3.20	0.126
U	1.60	0.063

Notes:

- 1 Only ground signal traces are allowed directly under the package
- 2 Primary dimensions are in millimeters alternate dimensions are in inches.

Package Type: 8 Pin Plastic Module Package

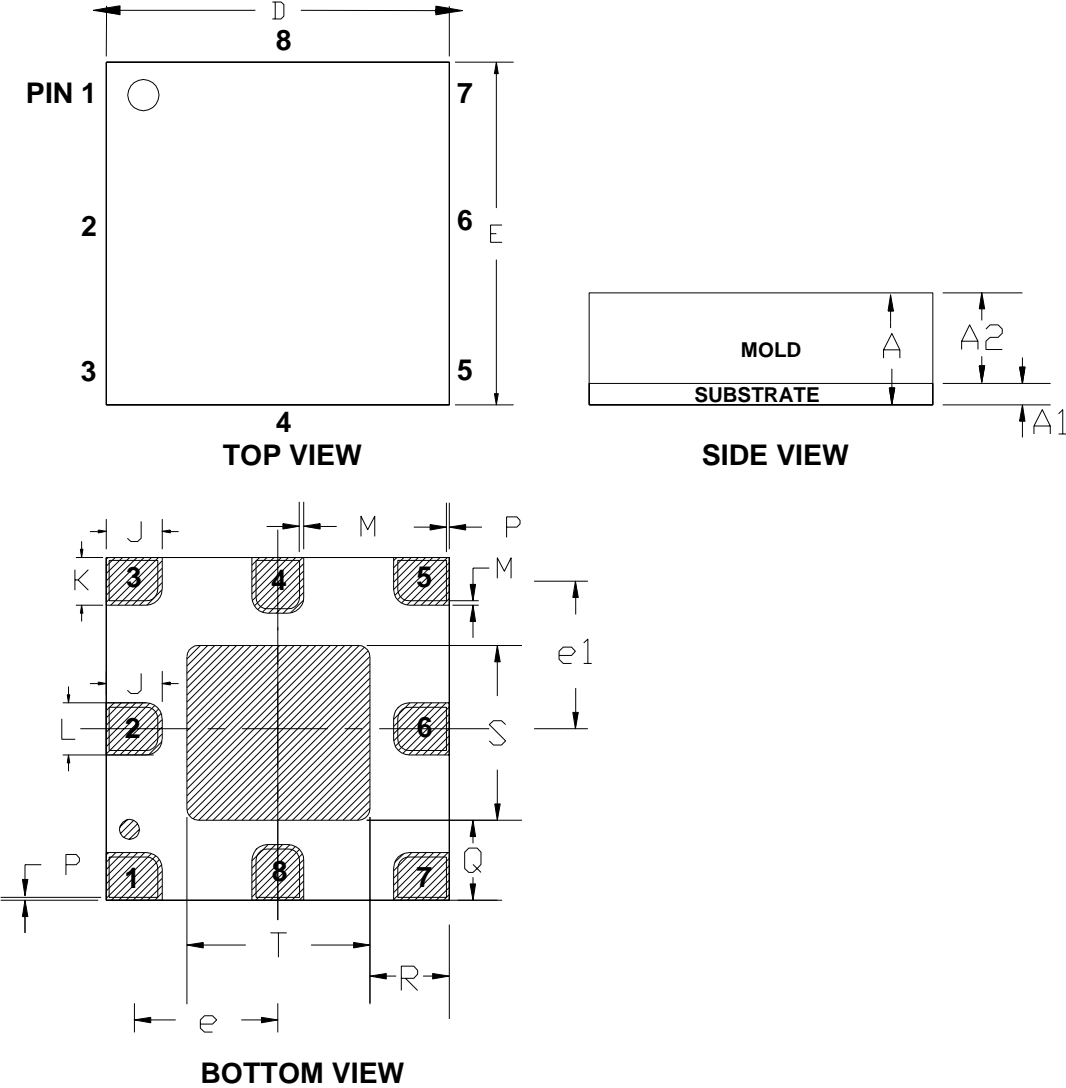

**TQM7136-Preliminary
Data Sheet**

Package Type: 8 Pin Plastic Module Package (cont'd)

DESIGNATION	DESCRIPTION		NOTE
A	OVERALL HEIGHT	1.42 +/-0.09 mm	
A1	SUBSTRATE THICKNESS	0.32 +/-0.05 mm	
A2	MOLD THICKNESS	1.10 +/-0.05 mm	
D	PACKAGE LENGTH	6.0 +/-0.1 mm	
E	PACKAGE WIDTH	6.0 +/-0.1 mm	
J	TERMINAL SOLDER MASK OPENING LENGTH (FOR ALL TERMINALS)	0.975 +/-0.035 mm	
K	TERMINAL SOLDER MASK OPENING WIDTH FOR TERMINAL 1, 3, 5, 7	0.835 +/-0.035 mm	
L	TERMINAL SOLDER MASK OPENING WIDTH FOR TERMINAL 2, 4, 6, 8	0.91 +/-0.035 mm	
M	DISTANCE BETWEEN METAL PAD AND SOLDER MASK	0.075 +/-0.02 mm	
P	DISTANCE BETWEEN METAL PAD AND PACKAGE EDGE	0.05 +/-0.02 mm	
T	GND SOLDER MASK OPENING LENGTH	3.2 +/-0.1 mm	1
S	GND SOLDER MASK OPENING WIDTH	3.06 +/-0.1 mm	1
R	DISTANCE BETWEEN MASK OPENING AND PACKAGE EDGE	1.39 +/-0.2 mm	1
Q	DISTANCE BETWEEN MASK OPENING AND PACKAGE EDGE	1.40 +/-0.2 mm	1
E	TERMINAL PITCH FOR TERMINAL 3-4-5 AND 7-8-1	2.513 mm	
e1	TERMINAL PITCH FOR TERMINAL 1-2-3 AND 5-6-7	2.583 mm	

Notes:

1. GND SOLDER MASK OPENING IS NOT CENTERED ON THE PACKAGE

Additional Information

For latest specifications, additional product information, worldwide sales and distribution locations, and information about TriQuint:

Web: www.triquint.com Tel: (503) 615-9000
 Email: info_wireless@tqs.com Fax: (503) 615-8902

For technical questions and additional information on specific applications:

Email: info_wireless@tqs.com

The information provided herein is believed to be reliable; TriQuint assumes no liability for inaccuracies or omissions. TriQuint assumes no responsibility for the use of this information, and all such information shall be entirely at the user's own risk. Prices and specifications are subject to change without notice. No patent rights or licenses to any of the circuits described herein are implied or granted to any third party.

TriQuint does not authorize or warrant any TriQuint product for use in life-support devices and/or systems.

Copyright © 2001 TriQuint Semiconductor, Inc. All rights reserved.

Revision A, December 20, 2001