

# CEP10N6/CEB10N6



PRELIMINARY

4

## N-Channel Logic Level Enhancement Mode Field Effect Transistor

### FEATURES

- 600V , 10A ,  $R_{DS(ON)}=1\Omega$  @  $V_{GS}=10V$ .
- Super high dense cell design for extremely low  $R_{DS(ON)}$ .
- High power and current handling capability.
- TO-220 & TO-263 package.

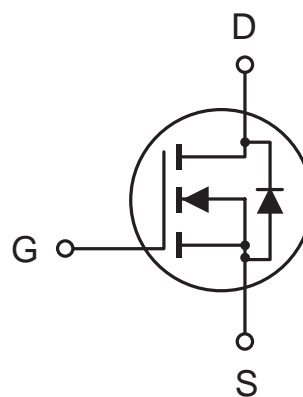

### ABSOLUTE MAXIMUM RATINGS (Tc=25°C unless otherwise noted)

Parameter	Symbol	Limit	Unit
Drain-Source Voltage	V <sub>DS</sub>	600	V
Gate-Source Voltage	V <sub>GS</sub>	±30	V
Drain Current-Continuous -Pulsed	I <sub>D</sub>	10	A
	I <sub>DM</sub>	30	A
Drain-Source Diode Forward Current	I <sub>S</sub>	10	A
Maximum Power Dissipation @Tc=25°C Derate above 25°C	P <sub>D</sub>	156	W
		1.25	W/°C
Operating and Storage Temperature Range	T <sub>J</sub> , T <sub>STG</sub>	-55 to 150	°C

### THERMAL CHARACTERISTICS

Thermal Resistance, Junction-to-Case	R <sub>θJC</sub>	0.8	°C/W
Thermal Resistance, Junction-to-Ambient	R <sub>θJA</sub>	62.5	°C/W

# CEP10N6/CEB10N6

## ELECTRICAL CHARACTERISTICS (Tc=25°C unless otherwise noted)

4

Parameter	Symbol	Condition	Min	Typ	Max	Unit
<b>DRAIN-SOURCE AVALANCHE RATING<sup>a</sup></b>						
Single Pulse Drain-Source Avalanche Energy	E <sub>AS</sub>	V <sub>DD</sub> =50V, L=11.8mH R <sub>G</sub> =25Ω		500		mJ
Maximum Drain-Source Avalanche Current	I <sub>AS</sub>			10		A
<b>OFF CHARACTERISTICS</b>						
Drain-Source Breakdown Voltage	BV <sub>DSS</sub>	V <sub>GS</sub> = 0V, I <sub>D</sub> = 250μA	600			V
Zero Gate Voltage Drain Current	I <sub>DSS</sub>	V <sub>DS</sub> = 600V, V <sub>GS</sub> = 0V			100	μA
Gate-Body Leakage	I <sub>GSS</sub>	V <sub>GS</sub> = ±30V, V <sub>DS</sub> = 0V			±100	nA
<b>ON CHARACTERISTICS<sup>a</sup></b>						
Gate Threshold Voltage	V <sub>GS(th)</sub>	V <sub>DS</sub> = V <sub>GS</sub> , I <sub>D</sub> = 250μA	2		4	V
Drain-Source On-State Resistance	R <sub>DS(ON)</sub>	V <sub>GS</sub> =10V, I <sub>D</sub> = 5A		0.75	1.0	Ω
On-State Drain Current	I <sub>D(ON)</sub>	V <sub>GS</sub> = 10V, V <sub>DS</sub> = 10V	10			A
Forward Transconductance	g <sub>FS</sub>	V <sub>DS</sub> = 40V, I <sub>D</sub> = 5A		9		S
<b>SWITCHING CHARACTERISTICS<sup>b</sup></b>						
Turn-On Delay Time	t <sub>D(ON)</sub>	V <sub>DD</sub> =300V, I <sub>D</sub> = 10A, V <sub>GS</sub> = 10V R <sub>GEN</sub> =25Ω		35	70	ns
Rise Time	t <sub>r</sub>			90	170	ns
Turn-Off Delay Time	t <sub>D(OFF)</sub>			170	255	ns
Fall Time	t <sub>f</sub>			120	180	ns
Total Gate Charge	Q <sub>g</sub>	V <sub>DS</sub> =480V, I <sub>D</sub> = 10A, V <sub>GS</sub> =10V		55	70	nC
Gate-Source Charge	Q <sub>gs</sub>			9		nC
Gate-Drain Charge	Q <sub>gd</sub>			22		nC

# CEP10N6/CEB10N6

4

## ELECTRICAL CHARACTERISTICS ( $T_c=25^\circ\text{C}$ unless otherwise noted)

Parameter	Symbol	Condition	Min	Typ	Max	Unit
<b>DYNAMIC CHARACTERISTICS<sup>b</sup></b>						
Input Capacitance	$C_{iss}$	$V_{DS}=25\text{V}, V_{GS}=0\text{V}$ $f=1.0\text{MHz}$		1500		pF
Output Capacitance	$C_{oss}$			125		pF
Reverse Transfer Capacitance	$C_{rss}$			50		pF
<b>DRAIN-SOURCE DIODE CHARACTERISTICS<sup>a</sup></b>						
Diode Forward Voltage	$V_{SD}$	$V_{GS}=0\text{V}, I_S=10\text{A}$			1.6	V

### Notes

a. Pulse Test: Pulse Width  $\leq 300 \mu\text{s}$ , Duty Cycle  $\leq 2\%$ .

b. Guaranteed by design, not subject to production testing.

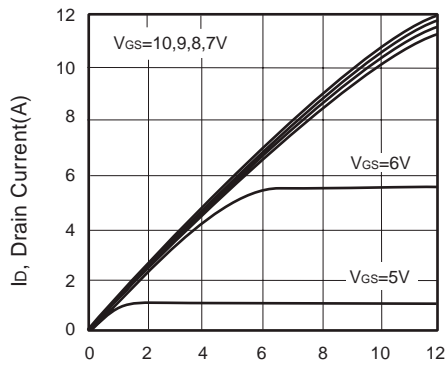

Figure 1. Output Characteristics

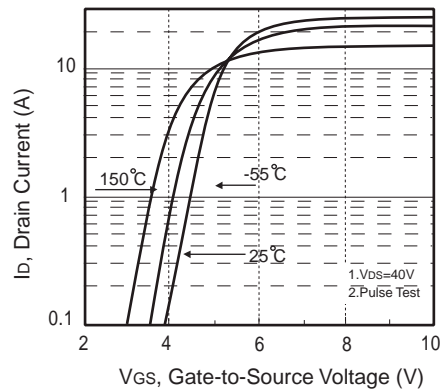

Figure 2. Transfer Characteristics

# CEP10N6/CEB10N6

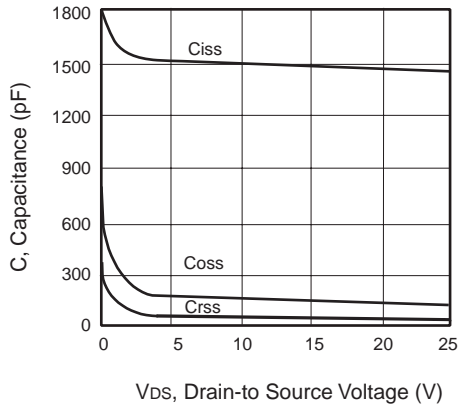

Figure 3. Capacitance

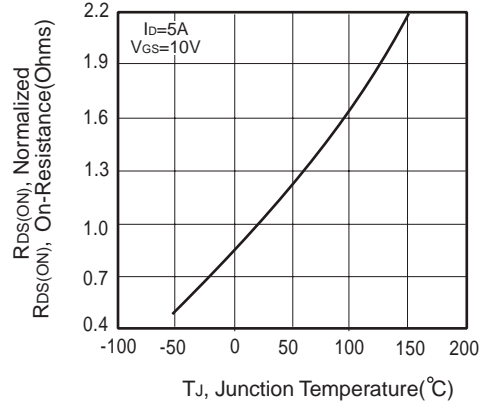

Figure 4. On-Resistance Variation with Temperature

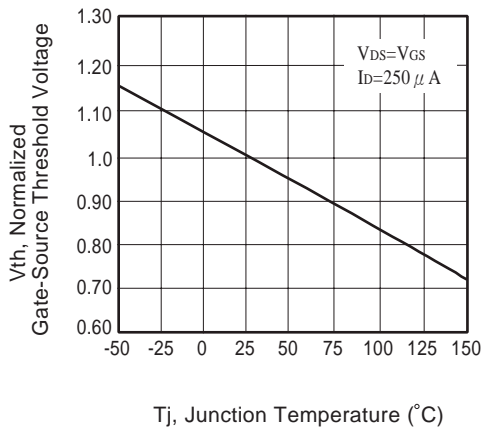

Figure 5. Gate Threshold Variation with Temperature

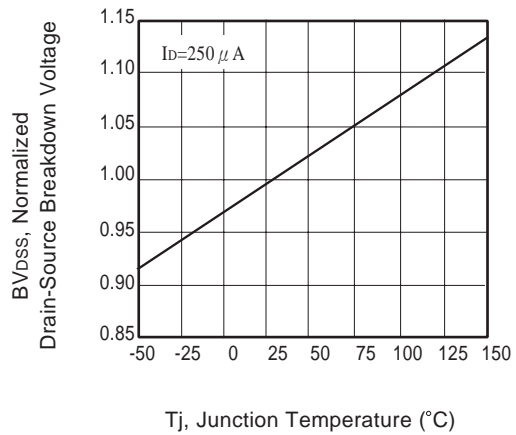

Figure 6. Breakdown Voltage Variation with Temperature

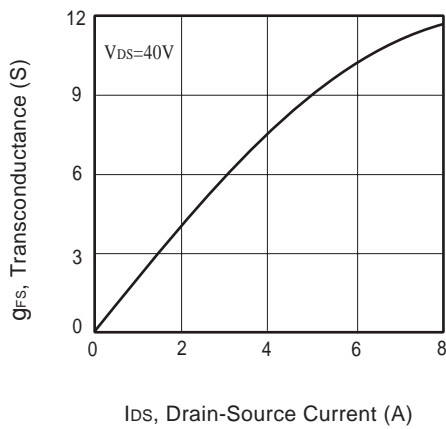

Figure 7. Transconductance Variation with Drain Current

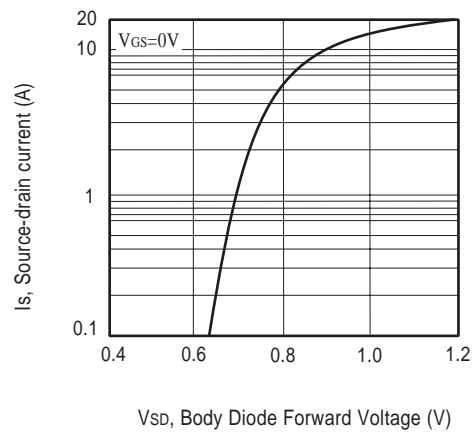

Figure 8. Body Diode Forward Voltage Variation with Source Current

# CEP10N6/CEB10N6

4

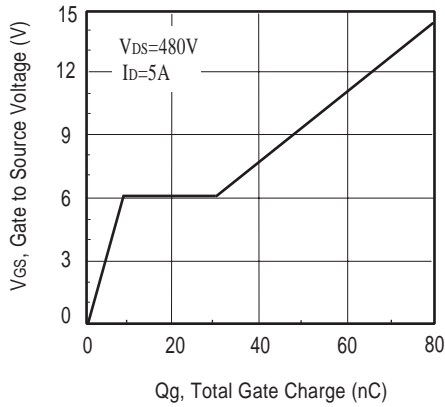

Figure 9. Gate Charge

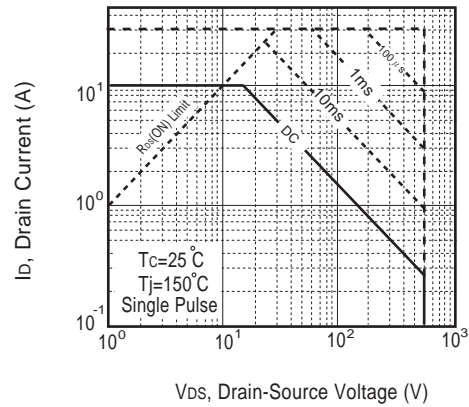

Figure 10. Maximum Safe Operating Area

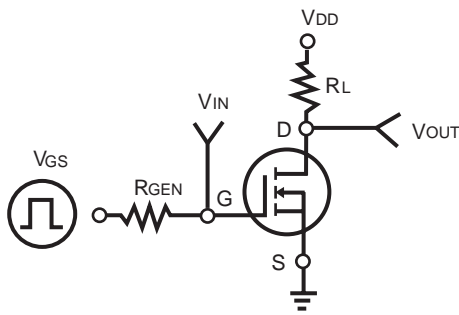

Figure 11. Switching Test Circuit

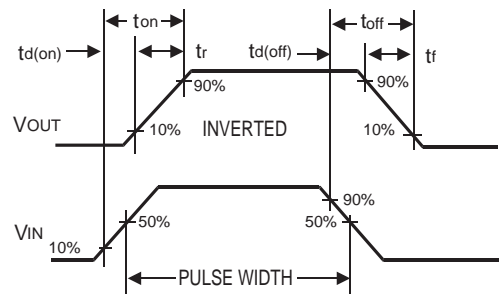

Figure 12. Switching Waveforms

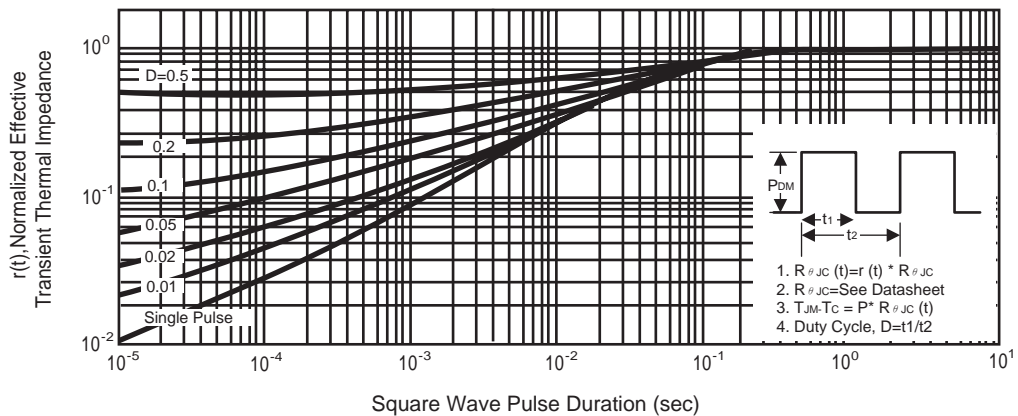

Figure 13. Normalized Thermal Transient Impedance Curve