

CEPF634/CEBF634

Nov. 2002

N-Channel Enhancement Mode Field Effect Transistor

4

FEATURES

- 250V , 8.1A , $R_{DS(ON)}=450m\Omega$ @ $V_{GS}=10V$.
- Super high dense cell design for extremely low $R_{DS(ON)}$.
- High power and current handling capability.
- TO-220 & TO-263 package.

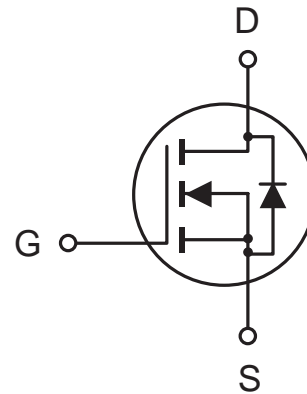

ABSOLUTE MAXIMUM RATINGS ($T_c=25^\circ\text{C}$ unless otherwise noted)

Parameter	Symbol	Limit	Unit
Drain-Source Voltage	V_{DS}	250	V
Gate-Source Voltage	V_{GS}	± 30	V
Drain Current-Continuous -Pulsed	I_D	8.1	A
	I_{DM}	32	A
Drain-Source Diode Forward Current	I_S	8.1	A
Maximum Power Dissipation @ $T_c=25^\circ\text{C}$ Derate above 25°C	P_D	74	W
		0.59	W/ $^\circ\text{C}$
Operating and Storage Temperature Range	T_J, T_{STG}	-55 to 150	$^\circ\text{C}$

THERMAL CHARACTERISTICS

Thermal Resistance, Junction-to-Case	$R_{\theta JC}$	1.7	$^\circ\text{C/W}$
Thermal Resistance, Junction-to-Ambient	$R_{\theta JA}$	62	$^\circ\text{C/W}$

CEPF634/CEBF634

4

ELECTRICAL CHARACTERISTICS (Tc=25°C unless otherwise noted)

Parameter	Symbol	Condition	Min	Typ	Max	Unit
OFF CHARACTERISTICS						
Drain-Source Breakdown Voltage	BV _{DSS}	V _{GS} = 0V, I _D = 250μA	250			V
Zero Gate Voltage Drain Current	I _{DSS}	V _{DS} = 250V, V _{GS} = 0V			25	μA
Gate-Body Leakage	I _{GSS}	V _{GS} = ±30V, V _{DS} = 0V			±100	nA
ON CHARACTERISTICS^a						
Gate Threshold Voltage	V _{GS(th)}	V _{DS} = V _{GS} , I _D = 250μA	2		4	V
Drain-Source On-State Resistance	R _{DS(ON)}	V _{GS} = 10V, I _D = 5.1A			450	mΩ
On-State Drain Current	I _{D(ON)}	V _{GS} = 10V, V _{DS} = 10V	10			A
Forward Transconductance	g _{FS}	V _{DS} = 50V, I _D = 5.1A		4.4		S
DYNAMIC CHARACTERISTICS^b						
Input Capacitance	C _{ISS}	V _{DS} = 25V, V _{GS} = 0V f = 1.0MHz		630		pF
Output Capacitance	C _{OSS}			100		pF
Reverse Transfer Capacitance	C _{RSS}			40		pF
SWITCHING CHARACTERISTICS^b						
Turn-On Delay Time	t _{D(ON)}	V _{DD} = 125V, I _D = 5.6A, V _{GS} = 10V, R _{GEN} = 12Ω		19	40	ns
Rise Time	t _r			11	30	ns
Turn-Off Delay Time	t _{D(OFF)}			46	90	ns
Fall Time	t _f			10	30	ns
Total Gate Charge	Q _g	V _{DS} = 200V, I _D = 5.6A, V _{GS} = 10V		26	33	nC
Gate-Source Charge	Q _{gs}			5		nC
Gate-Drain Charge	Q _{gd}			11		nC

CEPF634/CEBF634

ELECTRICAL CHARACTERISTICS ($T_c=25^\circ\text{C}$ unless otherwise noted)

4

Parameter	Symbol	Condition	Min	Typ	Max	Unit
DRAIN-SOURCE DIODE CHARACTERISTICS^a						
Diode Forward Voltage	V_{SD}	$V_{GS} = 0V, I_s = 8.1A$		0.9	1.5	V

Notes

- a. Pulse Test: Pulse Width $\leq 300 \mu\text{s}$, Duty Cycle $\leq 2\%$.
- b. Guaranteed by design, not subject to production testing.

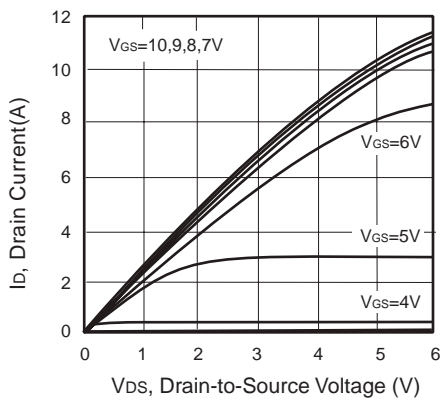

Figure 1. Output Characteristics

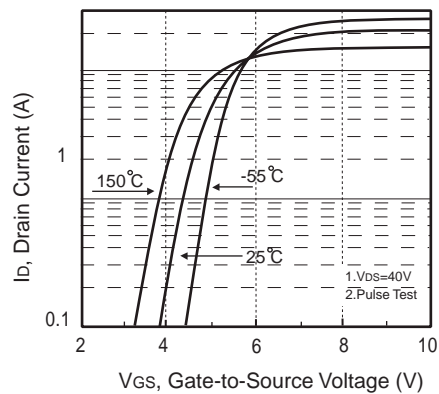

Figure 2. Transfer Characteristics

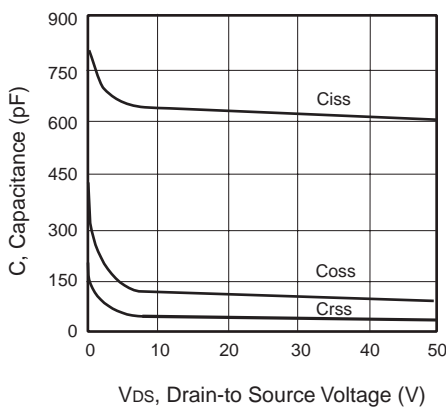

Figure 3. Capacitance

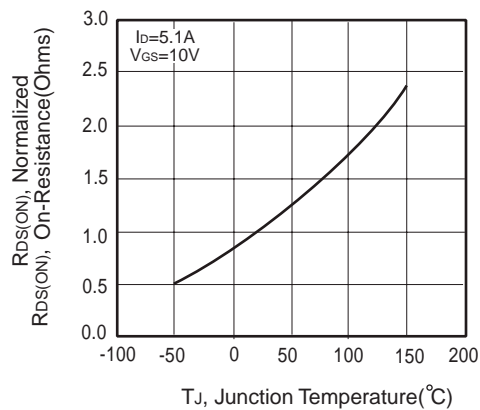

Figure 4. On-Resistance Variation with Temperature

CEPF634/CEBF634

4

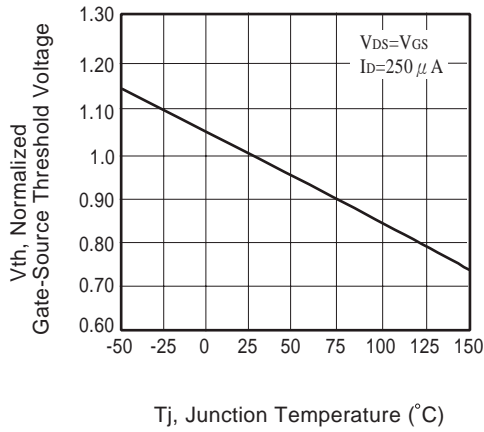

Figure 5. Gate Threshold Variation with Temperature

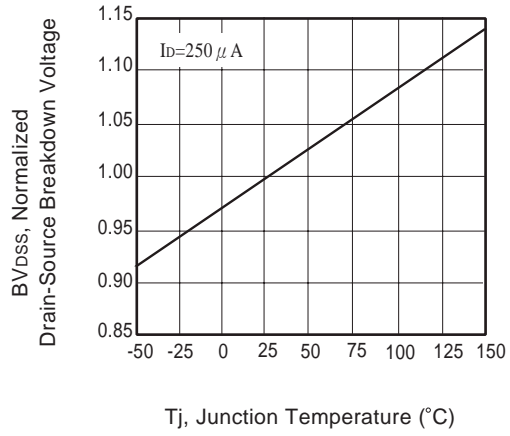

Figure 6. Breakdown Voltage Variation with Temperature

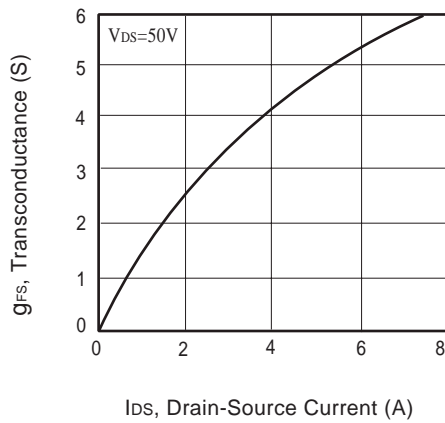

Figure 7. Transconductance Variation with Drain Current

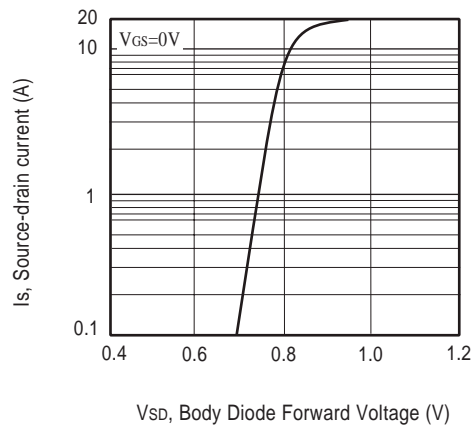

Figure 8. Body Diode Forward Voltage Variation with Source Current

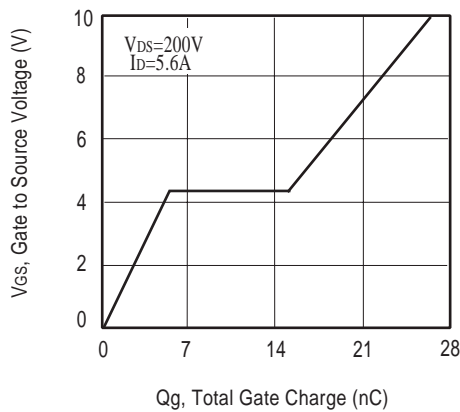

Figure 9. Gate Charge

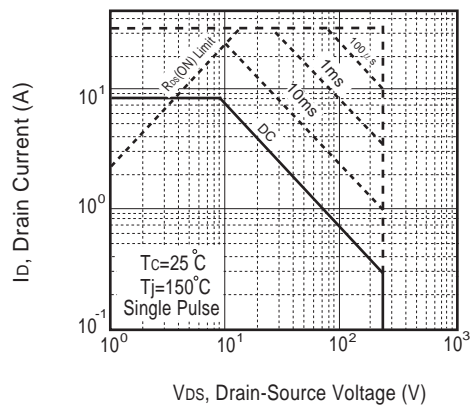

Figure 10. Maximum Safe Operating Area

CEPF634/CEBF634

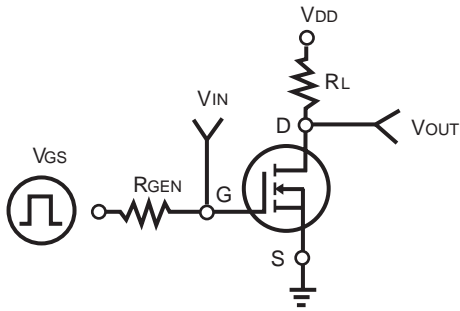

Figure 11. Switching Test Circuit

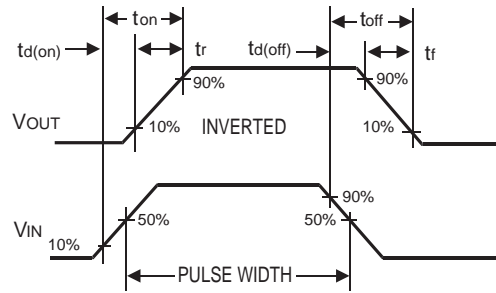

Figure 12. Switching Waveforms

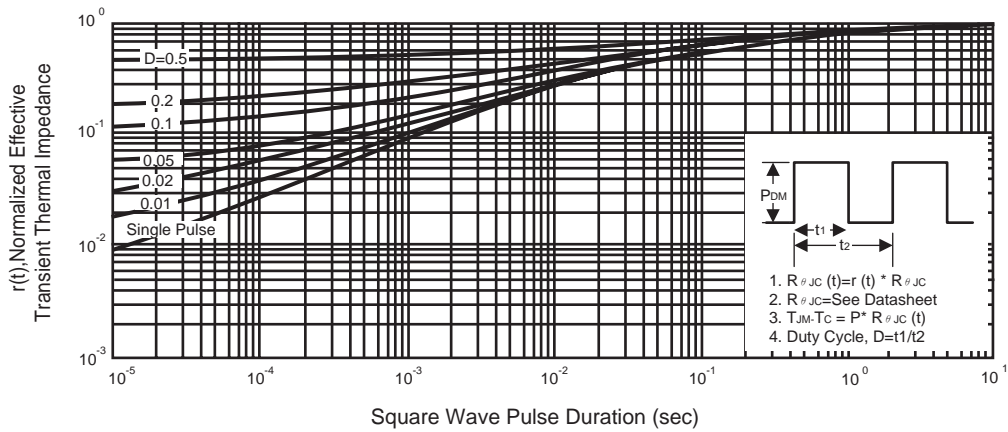

Figure 13. Normalized Thermal Transient Impedance Curve