

2.0-6.0 GHz GaAs MMIC Amplifier

Features

- ✕ High Gain: 16.5 dB
- ✕ 18 dBm P1dB
- ✕ Small Size: 39x40 mils
- ✕ Directly Cascadable
- ✕ Self-Biased
- ✕ Single Power Supply

General Description

Mimix Broadband's CMM-5 is a 2 to 6 GHz GaAs MMIC amplifier. It is a two-stage feedback design which provides high gain and good power from a single power supply. Applications include oscillator buffers, RF and IF gain blocks and driver amplifiers.

The CMM-5 is a very small chip which provides 16.5 dB of gain and 18 dBm of power from a 6 volt supply. The chip is directly cascadable with no additional components. The circuit's self-biasing feature provides excellent performance from a 5 to 7 volt supply. Care must be taken to isolate the input from the external DC voltages.

Mimix MMICs are fabricated on ion-implanted GaAs material with gold-based metalization. The FET gates are sub-half micron, tee cross-section construction. Air bridges are used for top level interconnection. Silicon nitride serves as capacitor dielectric and surface passivation. Mesa resistors are used for feedback and bias function.

The CMM-5 is available in chip form. It can be screened to meet commercial, military Hi-Rel or space grade reliability requirements. Custom wafer qualification for special electrical and/or reliability requirements is also available.

Chip Diagram

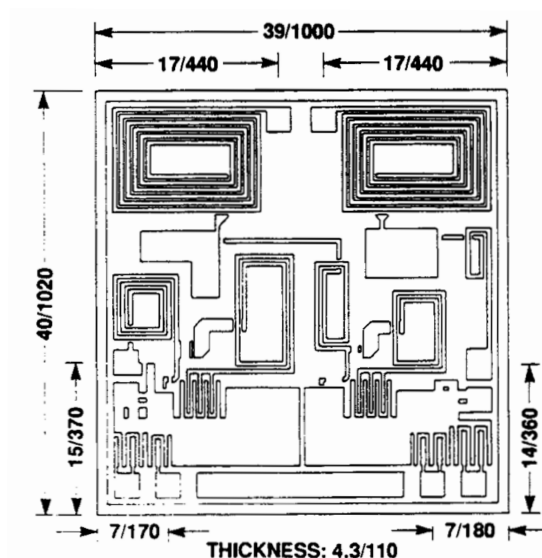

Absolute Maximum Ratings

Voltage	8V
Continuous Power Dissipation	1.25 W
Channel Temperature	+175 °C
Storage Temperature	-65 to +175 °C
Mounting Temperature	+320 °C
Input Power	+20 dBm
θ_{JC}	60 °C/W

2.0-6.0 GHz GaAs MMIC Amplifier

Specifications ($T_A = 25^\circ\text{C}$, $V_{DD} = 6\text{V}$, 2-6 GHz)

Parameters	Units	Min	Typ	Max
Small Signal Gain	dB	15.0	16.5	
Gain Flatness	±dB		1.0	1.5
Input VSWR	—		2.0:1	2.2:1
Output VSWR	—		1.8:1	2.0:1
Reverse Isolation	dB	25	30	
Gain Variation Over Temperature (-55 to +95°C)	±dB		1.2	1.5
Noise Figure	dB		5.5	6.5
1 dB Gain Compression Power Output	dBm	16	18	
Current	mA		100	120

Die Attach and Bonding Procedures

Die Attach: Conductive epoxy or preform die attach is recommended. For preform die attach: Preform: AuSn (80% Au, 20% Sn); Stage Temperature: 290 °C, +/-5 °C; Handling Tool: Tweezers; Time: 1 min or less.

Wire Bonding: Wire Size: 0.7 to 1.0 mil in diameter (pre-stressed); Thermocompression bonding is preferred over thermosonic bonding. For thermocompression bonding: Stage Temperature: 250 °C ; Bond Tip Temperature: 150 °C; Bonding Tip Pressure: 18 to 40 gms depending on size of wire.

Bonding Diagram

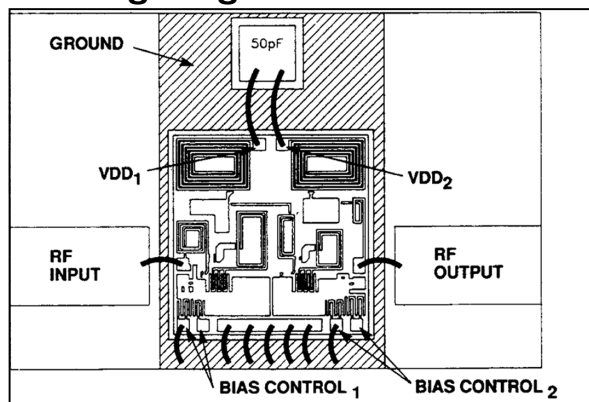

2.0-6.0 GHz GaAs MMIC Amplifier

January 2007 - Rev 15-Jan-07

CMM-5-BD

Typical Performance ($T_A = 25^\circ\text{C}$)

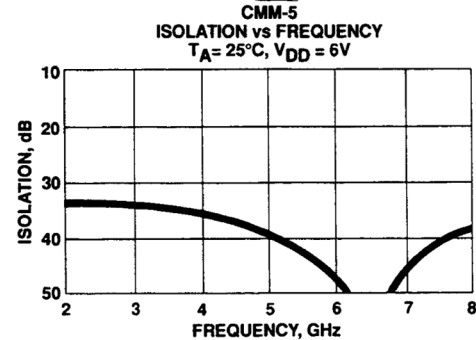
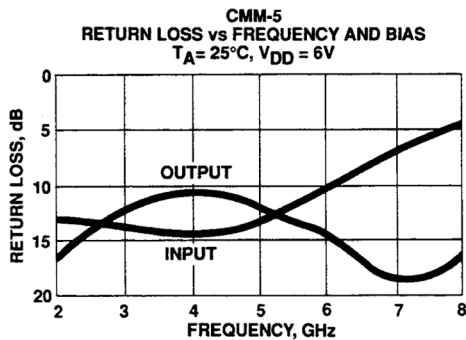
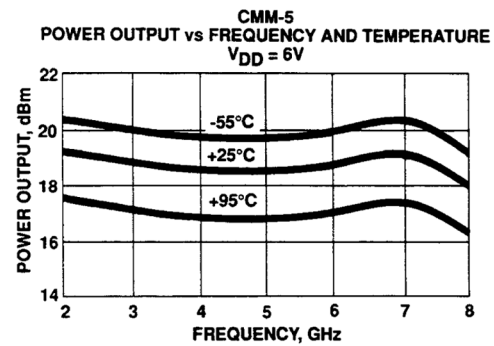
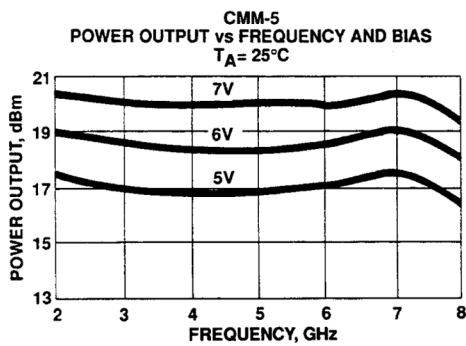
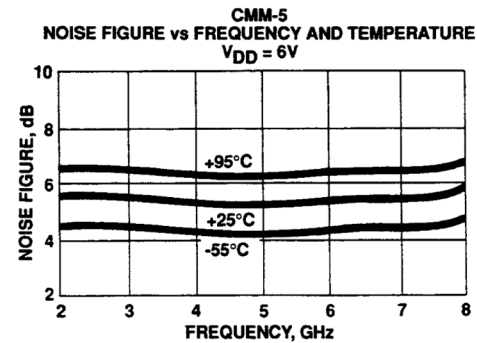
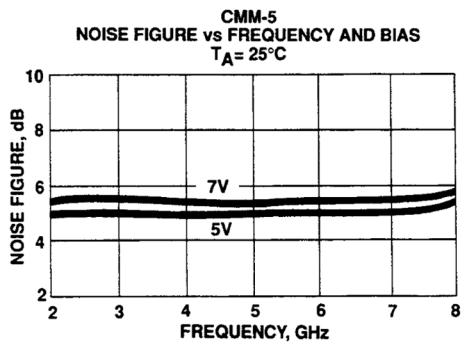
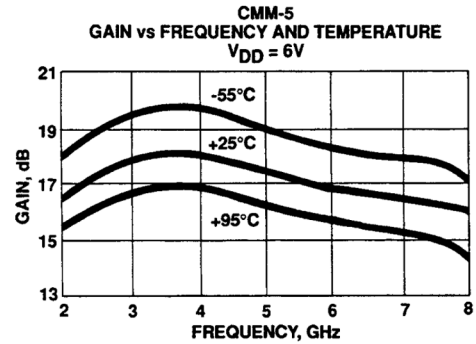
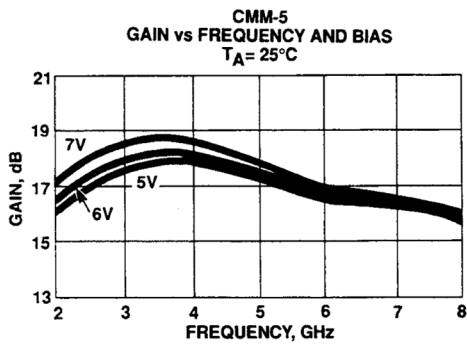

2.0-6.0 GHz GaAs MMIC Amplifier

Typical Scattering Parameters, $T_A = 25^\circ\text{C}$ (S-Parameters Include Bonding Wire Parasitics)

CMM-5 $V_{DD} = 6\text{ V}$

Frequency (GHz)	S_{11}		S_{21}			S_{12}			S_{22}		
	(dB)	(Mag) (Ang)	(dB)	(Mag) (Ang)	(dB)	(Mag) (Ang)	(dB)	(Mag) (Ang)	(dB)	(Mag) (Ang)	
2.0	-13.0	0.223 -178.7	16.5	6.672 -45.6	-33.2	0.022 31.7	-17.1	0.139 -76.7			
3.0	-14.2	0.195 160.6	17.9	7.833 -105.8	-34.9	0.018 12.1	-11.7	0.260 -136.3			
4.0	-14.4	0.191 143.7	17.9	7.828 -166.9	-36.5	0.015 1.1	-10.5	0.298 174.2			
5.0	-13.2	0.219 133.2	17.2	7.278 138.4	-40.0	0.010 -17.7	-12.0	0.253 137.6			
6.0	-10.3	0.305 114.8	16.7	6.859 86.7	-50.5	0.003 -48.2	-14.6	0.186 105.4			
7.0	-7.1	0.442 80.8	16.4	6.615 32.3	-46.0	0.005 158.2	-19.0	0.112 56.2			
8.0	-4.4	0.605 30.6	15.5	5.966 -27.5	-40.0	0.010 114.7	-16.5	0.149 -37.5			

Equivalent Circuit

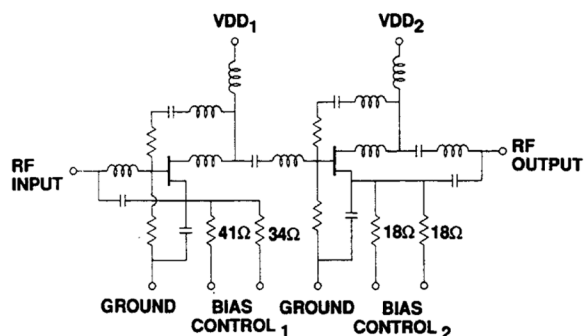

Wafer Qualification Procedure

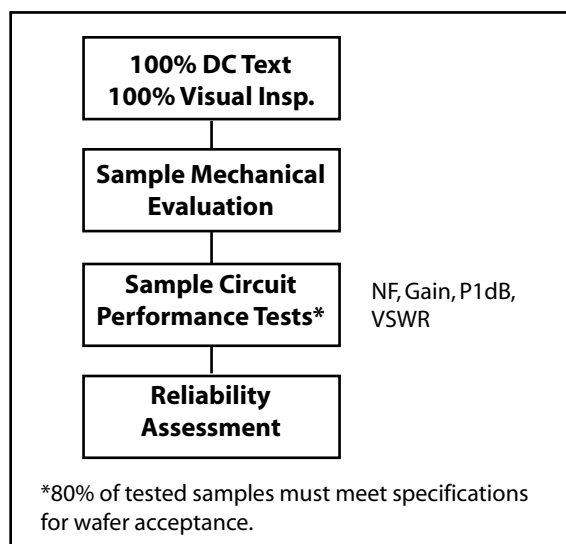

2.0-6.0 GHz GaAs MMIC Amplifier

Handling and Assembly Information

CAUTION! - Mimix Broadband MMIC Products contain gallium arsenide (GaAs) which can be hazardous to the human body and the environment. For safety, observe the following procedures:

- *Do not ingest.*
- *Do not alter the form of this product into a gas, powder, or liquid through burning, crushing, or chemical processing as these by-products are dangerous to the human body if inhaled, ingested, or swallowed.*
- *Observe government laws and company regulations when discarding this product. This product must be discarded in accordance with methods specified by applicable hazardous waste procedures.*

Life Support Policy - Mimix Broadband's products are not authorized for use as critical components in life support devices or systems without the express written approval of the President and General Counsel of Mimix Broadband. As used herein: (1) Life support devices or systems are devices or systems which, (a) are intended for surgical implant into the body, or (b) support or sustain life, and whose failure to perform when properly used in accordance with instructions for use provided in the labeling, can be reasonably expected to result in a significant injury to the user. (2) A critical component is any component of a life support device or system whose failure to perform can be reasonably expected to cause the failure of the life support device or system, or to affect its safety or effectiveness.

ESD - Gallium Arsenide (GaAs) devices are susceptible to electrostatic and mechanical damage. Die are supplied in antistatic containers, which should be opened in cleanroom conditions at an appropriately grounded antistatic workstation. Devices need careful handling using correctly designed collets, vacuum pickups or, with care, sharp tweezers.

Die Attachment - GaAs Products from Mimix Broadband are 0.076 mm (0.003") thick and have vias through to the backside to enable grounding to the circuit. Microstrip substrates should be brought as close to the die as possible. The mounting surface should be clean and flat. If using conductive epoxy, recommended epoxies are Tanaka TS3332LD, Die Mat DM6030HK or DM6030HK-Pt cured in a nitrogen atmosphere per manufacturer's cure schedule. Apply epoxy sparingly to avoid getting any on to the top surface of the die. An epoxy fillet should be visible around the total die periphery. For additional information please see the Mimix "Epoxy Specifications for Bare Die" application note. If eutectic mounting is preferred, then a fluxless gold-tin (AuSn) preform, approximately 0.001² thick, placed between the die and the attachment surface should be used. A die bonder that utilizes a heated collet and provides scrubbing action to ensure total wetting to prevent void formation in a nitrogen atmosphere is recommended. The gold-tin eutectic (80% Au 20% Sn) has a melting point of approximately 280° C (Note: Gold Germanium should be avoided). The work station temperature should be 310°C +/- 10°C. Exposure to these extreme temperatures should be kept to minimum. The collet should be heated, and the die pre-heated to avoid excessive thermal shock. Avoidance of air bridges and force impact are critical during placement.

Wire Bonding - Windows in the surface passivation above the bond pads are provided to allow wire bonding to the die's gold bond pads. The recommended wire bonding procedure uses 0.076 mm x 0.013 mm (0.003" x 0.0005") 99.99% pure gold ribbon with 0.5-2% elongation to minimize RF port bond inductance. Gold 0.025 mm (0.001") diameter wedge or ball bonds are acceptable for DC Bias connections. Aluminum wire should be avoided. Thermo-compression bonding is recommended though thermosonic bonding may be used providing the ultrasonic content of the bond is minimized. Bond force, time and ultrasonics are all critical parameters. Bonds should be made from the bond pads on the die to the package or substrate. All bonds should be as short as possible.

RoHS Compliant Parts - All Mimix products are RoHS compliant unless specifically ordered with Tin-Lead finish.

Part Number for Ordering

CMM-5-BD-000X

Description

Where "X" is RoHS compliant die packed in "V" - vacuum release gel packs or
"W" - waffle trays