

1.0A SURFACE MOUNT GLASS PASSIVATED BRIDGE RECTIFIER

Features

- Glass Passivated Die Construction
- Low Forward Voltage Drop
- High Current Capability
- High Surge Current Capability
- Designed for Surface Mount Application
- Plastic Material – UL Recognition Flammability Classification 94V-O

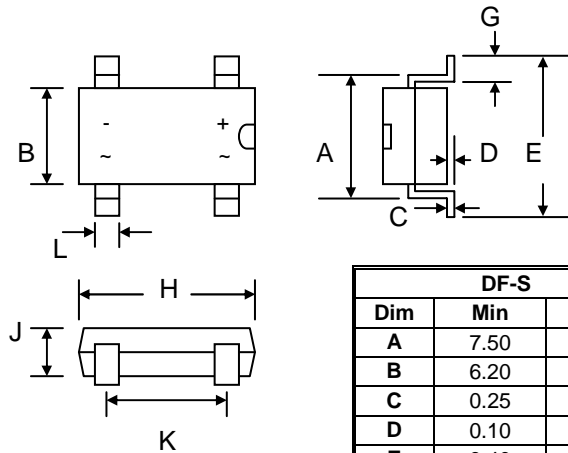

DF-S		
Dim	Min	Max
A	7.50	8.50
B	6.20	6.80
C	0.25	—
D	0.10	0.28
E	9.40	10.30
G	1.02	1.53
H	8.00	8.51
J	2.20	2.60
K	5.00	5.20
L	0.89	1.20
All Dimensions in mm		

Mechanical Data

- Case: DF-S, Molded Plastic
- Terminals: Plated Leads Solderable per MIL-STD-202, Method 208
- Polarity: As Marked on Case
- Weight: 1.0 grams (approx.)
- Mounting Position: Any
- Marking: Type Number
- **Lead Free: For RoHS / Lead Free Version, Add “-LF” Suffix to Part Number, See Page 4**

Maximum Ratings and Electrical Characteristics @ $T_A=25^\circ\text{C}$ unless otherwise specified

Single Phase, half wave, 60Hz, resistive or inductive load.
For capacitive load, derate current by 20%.

Characteristic	Symbol	DF	DF	DF	DF	DF	DF	DF	Unit
		005S	01S	02S	04S	06S	08S	10S	
Peak Repetitive Reverse Voltage	V_{RRM}								V
Working Peak Reverse Voltage	V_{RWM}	50	100	200	400	600	800	1000	
DC Blocking Voltage	V_R								
RMS Reverse Voltage	$V_{R(RMS)}$	35	70	140	280	420	560	700	V
Average Rectified Output Current @ $T_A = 40^\circ\text{C}$	I_O	1.0							A
Non-Repetitive Peak Forward Surge Current 8.3ms Single half sine-wave superimposed on rated load (JEDEC Method)	I_{FSM}	50							A
Forward Voltage per element @ $I_F = 1.0\text{A}$	V_{FM}	1.1							V
Peak Reverse Current @ $T_A = 25^\circ\text{C}$ At Rated DC Blocking Voltage @ $T_A = 125^\circ\text{C}$	I_{RM}	5.0 500							μA
Typical Junction Capacitance per element (Note 1)	C_j	25							pF
Typical Thermal Resistance per leg (Note 2)	$R_{\theta JA}$ $R_{\theta JL}$	40 15							$^\circ\text{C/W}$
Operating and Storage Temperature Range	T_j, T_{STG}	-65 to +150							$^\circ\text{C}$

Note: 1. Measured at 1.0 MHz and applied reverse voltage of 4.0V D.C.
2. Mounted on PC board with 13mm² copper pad.

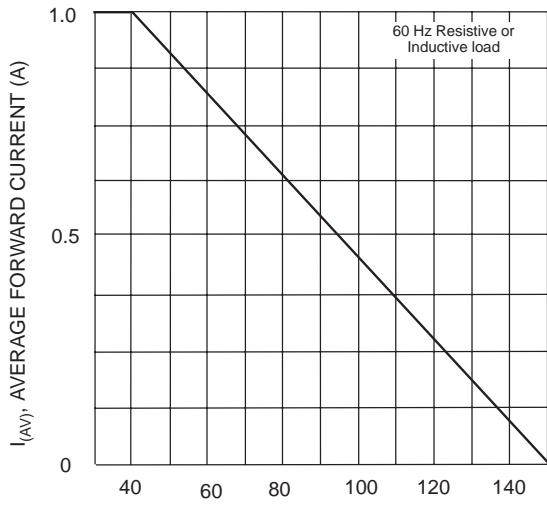

T_A , AMBIENT TEMPERATURE (°C)
Fig. 1 Output Current Derating Curve

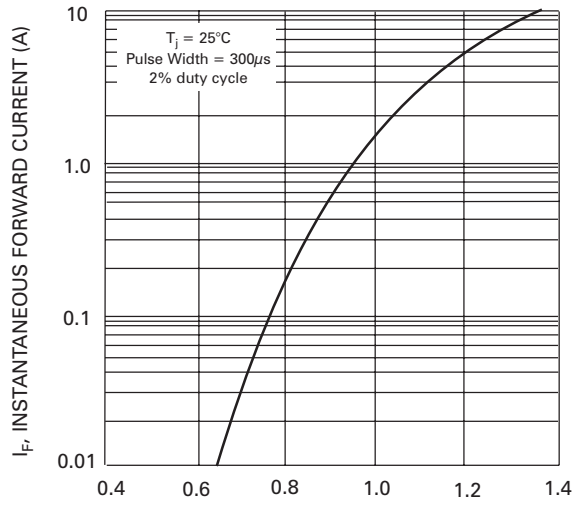

V_F , INSTANTANEOUS FORWARD VOLTAGE (V)
Fig. 2 Typ Forward Characteristics (per element)

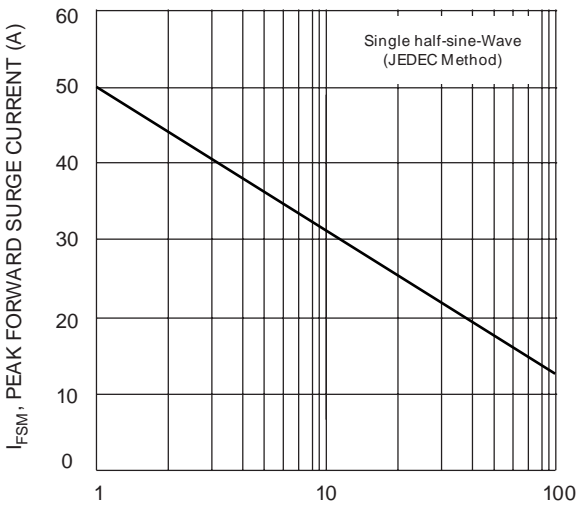

NUMBER OF CYCLES AT 60 Hz
Fig. 3 Max Non-Repetitive Peak Forward Surge Current

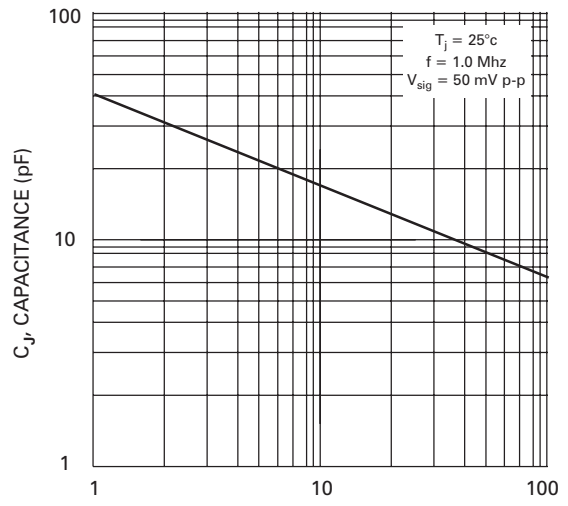

V_R , REVERSE VOLTAGE (V)
Fig. 4 Typ Junction Capacitance (per element)

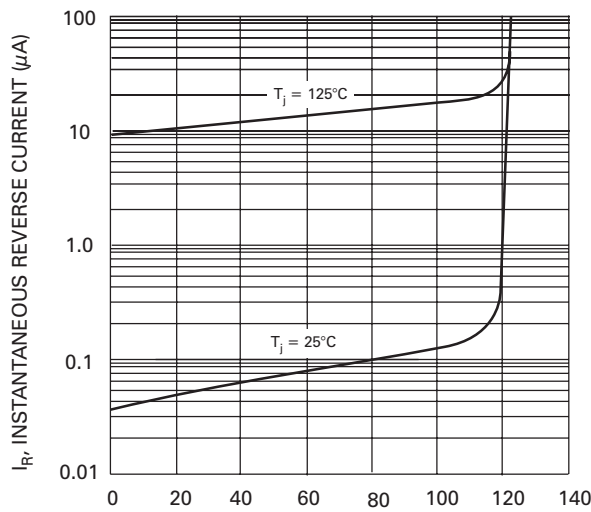

PERCENT OF RATED PEAK REVERSE VOLTAGE (%)
Fig. 5 Typ Reverse Characteristics (per element)

MARKING INFORMATION

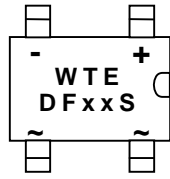

WTE = Manufacturer's Logo
 DFxxS = Device Number
 xx = 005, 01, 02, 04, 06, 08 or 10
 Polarity = As Marked on Body

RECOMMENDED FOOTPRINT

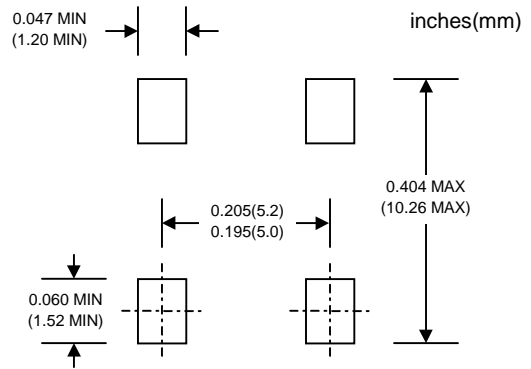

PACKAGING INFORMATION

TAPE & REEL

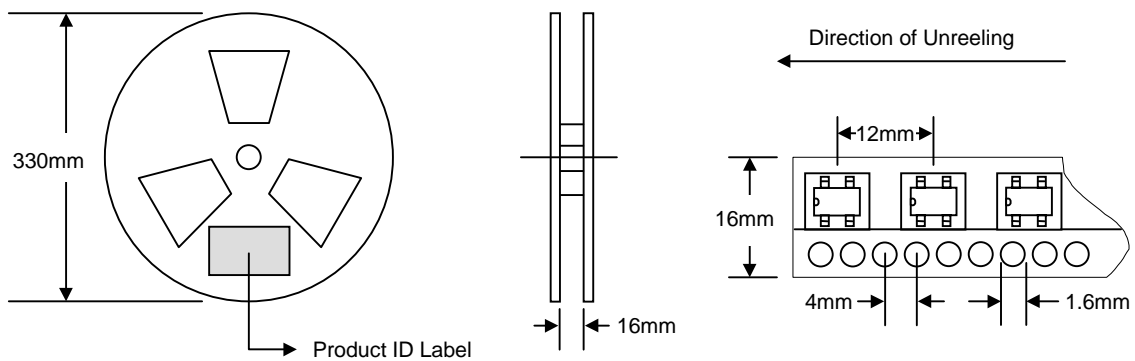

Reel Diameter (mm)	Quantity (PCS)	Inner Box Size L x W x H (mm)	Quantity (PCS)	Carton Size L x W x H (mm)	Quantity (PCS)	Approx. Gross Weight (KG)
330	1,500	340 x 337 x 45	3,000	370 x 370 x 420	24,000	17.0

Note: 1. Anti-static or paper reel, blue or white color.
 2. Components are packed in accordance with EIA standard 481-1 and 481-2.

ORDERING INFORMATION

Product No.	Package Type	Shipping Quantity
DF005S-T3	DIL Bridge SMD	1500/Tape & Reel
DF01S-T3	DIL Bridge SMD	1500/Tape & Reel
DF02S-T3	DIL Bridge SMD	1500/Tape & Reel
DF04S-T3	DIL Bridge SMD	1500/Tape & Reel
DF06S-T3	DIL Bridge SMD	1500/Tape & Reel
DF08S-T3	DIL Bridge SMD	1500/Tape & Reel
DF10S-T3	DIL Bridge SMD	1500/Tape & Reel

1. Shipping quantity given is for minimum packing quantity only. For minimum order quantity, please consult the Sales Department.
2. **To order Lead Free version (with Lead Free finish), add "-LF" suffix to part number above. For example, DF005S-T3-LF.**

Won-Top Electronics Co., Ltd (WTE) has checked all information carefully and believes it to be correct and accurate. However, WTE cannot assume any responsibility for inaccuracies. Furthermore, this information does not give the purchaser of semiconductor devices any license under patent rights to manufacturer. WTE reserves the right to change any or all information herein without further notice.

WARNING: DO NOT USE IN LIFE SUPPORT EQUIPMENT. WTE power semiconductor products are not authorized for use as critical components in life support devices or systems without the express written approval.

Won-Top Electronics Co., Ltd.

No. 44 Yu Kang North 3rd Road, Chine Chen Dist., Kaohsiung, Taiwan

Phone: 886-7-822-5408 or 886-7-822-5410

Fax: 886-7-822-5417

Email: sales@wontop.com

Internet: <http://www.wontop.com>

We power your everyday.