



M.S.KENNEDY CORP.

**HIGH CURRENT, VERY LOW OUTPUT SURFACE MOUNT VOLTAGE REGULATORS**

**5251 SERIES**

4707 Dey Road Liverpool, N.Y. 13088

(315) 701-6751

**FEATURES:**

- Ultra-Fast Transient Response
- Very Low Output Voltage
- Available in 0.8V, 0.9V, 1.0V, 1.2V, 1.3V and 1.5V
- On Board Thermal Shut Down
- Reverse Battery and Load Dump Protection
- 1% Maximum Guaranteed Accuracy
- Output Current to 5 Amps
- Alternate Output Voltages Available
- Ultra-Low Package Height - 0.110" Max.
- Contact MSK for MIL-PRF-38534 Qualification Status

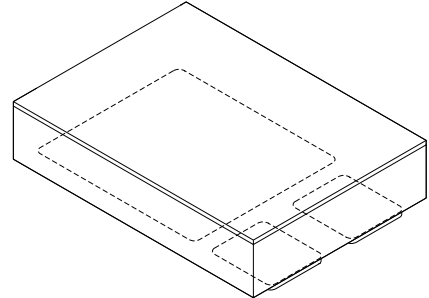

**DESCRIPTION:**

The MSK 5251 series voltage regulators offer high current and low output voltage capability ideal for use with low voltage microprocessors. Low output impedance, very fast transient response and minimal output capacitance requirements make the MSK 5251 an excellent choice for ASIC and FPGA core voltage supplies. The device is available in +0.8V, +0.9V, +1.0V, +1.2V, +1.3V and +1.5V output configurations with output accuracy guaranteed to 1% maximum. The MSK 5251 series is packaged in a low profile 3 pin hermetically sealed power surface mount ceramic package.

**EQUIVALENT SCHEMATIC**

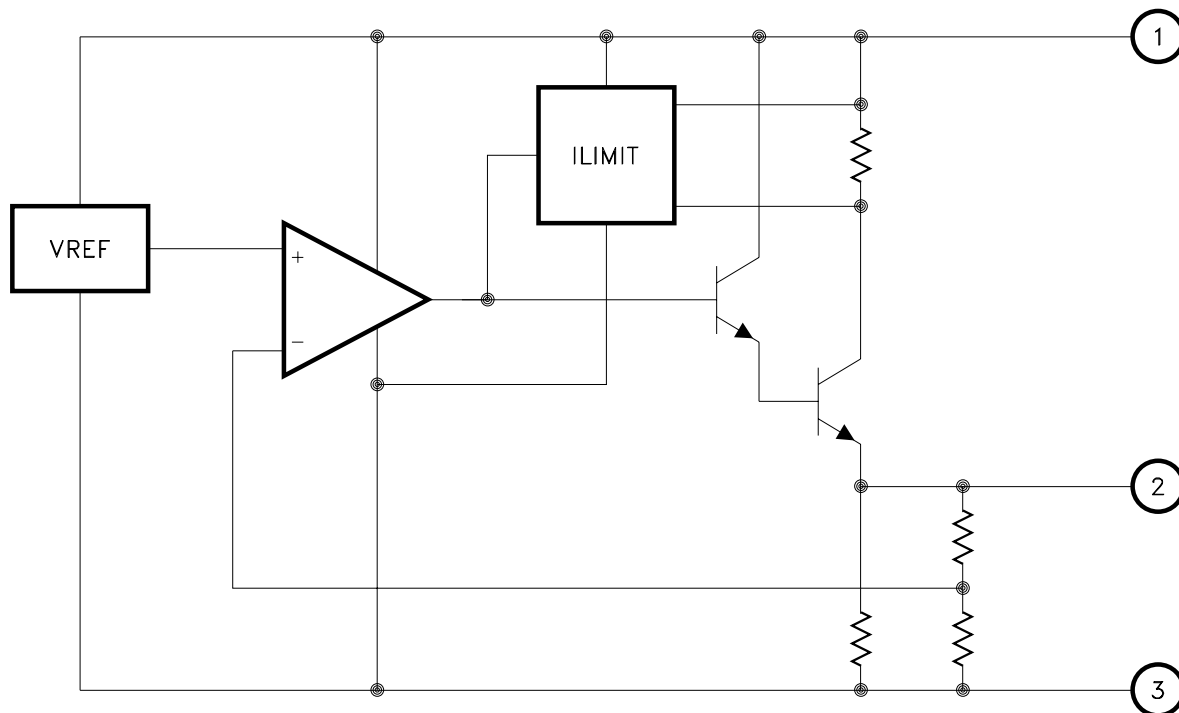

**TYPICAL APPLICATIONS**

- PLD/FPGA Core Power Supply
- ASIC Core Voltage Regulator
- System Power Supplies
- Switching Power Supply Post Regulators
- Battery Powered Equipment

**PIN-OUT INFORMATION**

- 1 VIN
- 2 VOUT
- 3 Ground

## ABSOLUTE MAXIMUM RATINGS <sup>⑨</sup>

V<sub>IN</sub> Input Voltage . . . . . +6.5V  
 P<sub>D</sub> Power Dissipation . . . . . Internally Limited

T<sub>ST</sub> Storage Temperature Range . . . . -65°C to +150°C  
 T<sub>LD</sub> Lead Temperature . . . . . 300°C  
 (10 Seconds Soldering)  
 T<sub>J</sub> Operating Temperature  
 MSK 5251 Series . . . . . -40°C to +85°C  
 MSK 5251H/E Series . . . . . -55°C to +125°C

## ELECTRICAL SPECIFICATIONS

Parameter	Test Conditions <sup>①</sup> <sup>③</sup>	Group A Subgroup	MSK 5251 H/E SERIES			MSK 5251 SERIES			Units
			Min.	Typ.	Max.	Min.	Typ.	Max.	
Input Voltage Range	V <sub>OUT</sub> < 1V	-	+3.0	-	+6.5	+3.0	-	+6.5	V
	V <sub>OUT</sub> > 1V	-	V <sub>OUT</sub> + 2.1	-	+6.5	V <sub>OUT</sub> + 2.1	-	+6.5	V
Quiescent Current <sup>②</sup>	I <sub>L</sub> = 0mA	1	-	48	60	-	48	70	mA
	I <sub>L</sub> = 5.0A	1	-	70	120	-	70	130	mA
Output Voltage Tolerance	V <sub>IN</sub> = 5V; I <sub>O</sub> = 10mA	1	-	±0.5	±1.0	-	±0.5	±1.2	%
		2B,3	-	±1.0	±2.0	-	-	-	%
Dropout Voltage <sup>②</sup>	ΔV <sub>OUT</sub> = -1%; I <sub>O</sub> = 2.5A	1	-	1.5	2.0	-	-	-	V
	ΔV <sub>OUT</sub> = -1%; I <sub>O</sub> = 5A	1	-	1.7	2.1	-	-	-	V
Load Regulation <sup>⑧</sup>	10mA ≤ I <sub>O</sub> ≤ 5.0A	1	-	±0.2	±1.0	-	±0.2	±1.2	%
		2,3	-	±0.3	±2.0	-	±0.3	-	%
Line Regulation	V <sub>IN</sub> Min to +6V I <sub>O</sub> = 10mA	1	-	±0.05	±0.5	-	±0.05	±0.6	%
		2,3	-	±0.5	±1.0	-	±0.5	-	%
Output Current Limit <sup>②</sup> <sup>⑧</sup>	V <sub>OUT</sub> = 0V	-	-	7.5	9.5	-	7.5	9.5	A
Thermal Resistance <sup>②</sup>	Junction to Case @ 125°C	-	-	1.6	2.0	-	1.6	2.2	°C/W
Thermal Shutdown	T <sub>J</sub>	-	-	140	-	-	140	-	°C
Turn On Time <sup>②</sup>	C <sub>OUT</sub> = 10μF	4	-	10	45	-	10	55	μS

PART NUMBER	OUTPUT VOLTAGE <sup>⑦</sup>
MSK5251-0.8	+0.8V
MSK5251-0.9	+0.9V
MSK5251-1.0	+1.0V
MSK5251-1.2	+1.2V
MSK5251-1.3	+1.3V
MSK5251-1.5	+1.5V

### NOTES:

- ① Output decoupled to ground using 10μF minimum capacitor unless otherwise specified.
- ② This parameter is guaranteed by design but need not be tested.  
Typical parameters are representative of actual device performance but are for reference only.
- ③ All output parameters are tested using a low duty cycle pulse to maintain T<sub>J</sub> = T<sub>C</sub>.
- ④ Industrial grade and "E" suffix devices shall be tested to subgroup 1 unless otherwise specified.
- ⑤ Military grade devices ('H' suffix) shall be 100% tested to subgroups 1,2,3.
- ⑥ Subgroup 1 T<sub>C</sub> = +25°C  
Subgroup 2 T<sub>J</sub> = +125°C  
Subgroup 2B T<sub>C</sub> = +135°C  
Subgroup 3 T<sub>A</sub> = -55°C
- ⑦ Please consult the factory if alternate output voltages are required.
- ⑧ Due to internal thermal shutdown, maximum output current may not be available at all values of V<sub>IN</sub>-V<sub>OUT</sub> and temperatures.  
See typical performance curves for clarification.
- ⑨ Continuous operation at or above absolute maximum ratings may adversely effect the device performance and/or life cycle.

## APPLICATION NOTES

### REGULATOR PROTECTION:

The MSK 5251 series are high performance linear regulators for high current, low voltage applications requiring fast transient response. The devices are fully protected from damage due to fault conditions, offering constant current limiting and thermal shutdown. The thermal shutdown junction temperature is typically 140°C and is 100% tested to verify thermal shutdown occurs above 130°C.

### INPUT SUPPLY VOLTAGE:

The input voltage must be maintained at a minimum of 3.0 volts for proper operation for devices with output voltage below 1.0 volt. With an output voltage of 1.0 volt or higher, the input voltage must be a minimum of 2.1 volts above the output.

### MINIMIZING POWER DISSIPATION:

To maximize the performance and reduce power dissipation of the MSK 5251 series devices,  $V_{in}$  should be maintained as close to dropout as possible. See Input Supply Voltage requirements. A series resistor can be used to lower  $V_{in}$  close to the dropout specification, lowering the input to output voltage differential. In turn, this will decrease the power that the device is required to dissipate. Knowing peak current requirements and worst case voltages, a resistor can be selected that will drop a portion of the excess voltage and help to distribute the heating. The circuit below illustrates this method.

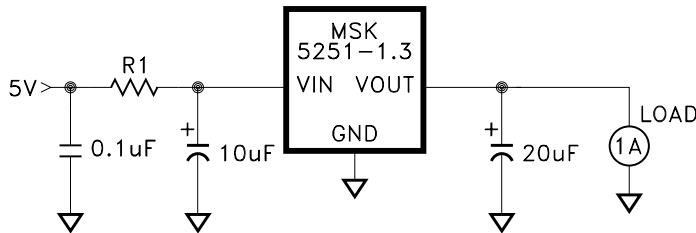

The maximum resistor value can be calculated from the following:

$$R1 \text{ max} = \frac{V_{in \text{ min}} - (V_{out \text{ max}} + V_{drop})}{I_{out \text{ peak}} + \text{Quiescent Current}}$$

Where:  $V_{in \text{ min}}$  = Minimum input voltage

$V_{out \text{ max}}$  = Maximum output voltage across the full temperature range

$V_{drop}$  = Worst case dropout voltage (Typically 2.1 Volts)

$I_{out \text{ peak}}$  = Maximum load current

Quiescent Current = Max. quiescent current at  $I_{out \text{ peak}}$

### INPUT CAPACITOR:

If the device is to be located more than 4 inches from the bulk supply capacitance, a minimum 1uF capacitor should be placed as close to the input pin as possible for proper bypassing. A smaller value capacitor such as 0.01uF should be placed in parallel with the larger value capacitor. Larger input capacitor values will help to improve ripple rejection.

### OUTPUT CAPACITOR:

The MSK 5251 series devices require a minimum of external components to maintain stability. A minimum of output capacitance is necessary for stable operation. Due to the wide bandwidth design, the device will operate with a wide range of capacitance and ESR values. For most applications, a 10uF ceramic capacitor will suffice. Ideally, this should be an X7R ceramic capacitor or a tantalum capacitor due to their thermal performance. There is no upper limit to the amount of output capacitance that may be used.

### THERMAL SHUTDOWN:

The MSK 5251 series of devices is equipped with a thermal shutdown circuit that will turn off the device when the junction temperature reaches approximately 140°C. It is important for the user to be aware that high temperature operation will limit the current capability of the device due to this thermal shutdown protection. In cases of maximum input voltage and high case temperature, the output current available may be less than 3 Amps. See curve below for clarification.

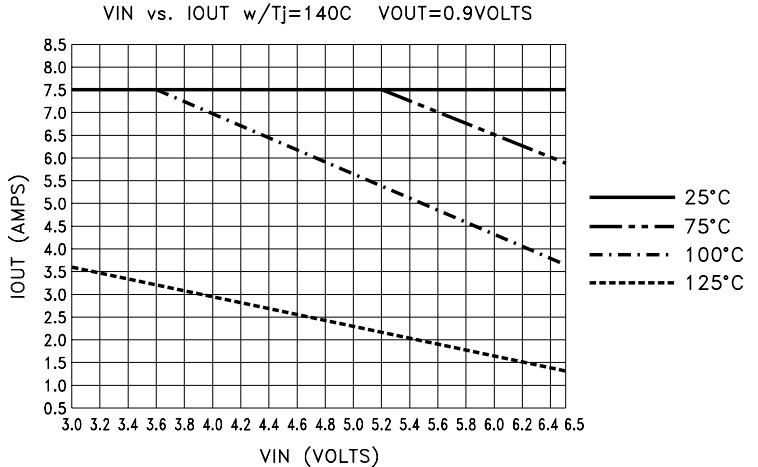

### PACKAGE CONNECTIONS:

The MSK 5251 series are highly thermally conductive devices and the thermal path from the package heat sink to the internal junctions is very short. Standard surface mount soldering techniques should be used when mounting the device. Some applications may require additional heat sinking of the device.

### HEAT SINK SELECTION:

To select a heat sink for the MSK 5251, the following formula for convective heat flow may be used:

First, the power dissipation must be calculated as follows:

$$\text{Power Dissipation} = (V_{in} - V_{out}) \times I_{out} + V_{in} \times \text{Quiescent Current}$$

Next, the user must select a maximum junction temperature. The equation may now be arranged to solve for the required heat sink to ambient thermal resistance ( $R_{\theta sa}$ ).

### EXAMPLE:

An MSK 5251-1.3 is configured for  $V_{in} = +3.4V$  and  $V_{out} = +1.3V$ .  $I_{out}$  is a continuous 5Amp DC level. Under these conditions the maximum quiescent current would be 120mA. The ambient temperature is +25°C and the maximum junction temperature is 125°C.

$$R_{\theta jc} = 2.0^{\circ}\text{C/W} \text{ and } R_{\theta cs} = 0.5^{\circ}\text{C/W} \text{ typically.}$$

$$\text{Power Dissipation} = (3.4V - 1.3V) \times (5A + 3.4 \times 120\text{mA})$$

$$\text{Solve for } R_{\theta sa}: = 10.9 \text{ Watts}$$

$$R_{\theta sa} = \left[ \frac{125^{\circ}\text{C} - 25^{\circ}\text{C}}{1.7\text{W}} \right] - 2.0^{\circ}\text{C/W} - 0.5^{\circ}\text{C/W}$$

$$= 6.67^{\circ}\text{C/W}$$

In this example, a heat sink with a thermal resistance of no more than 6.6°C/W must be used to maintain a junction temperature of no more than 125°C.

# TYPICAL PERFORMANCE CURVES

QUIESCENT CURRENT vs OUTPUT CURRENT

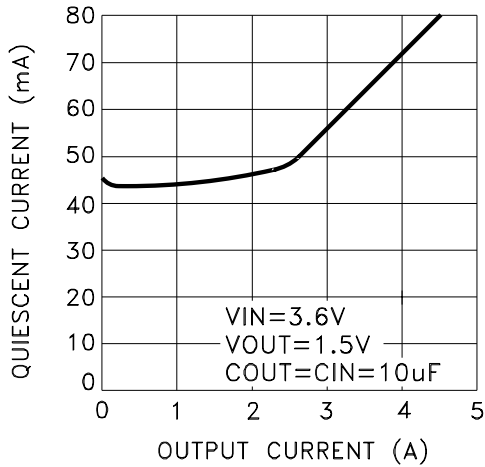

OUTPUT VOLTAGE vs TEMPERATURE

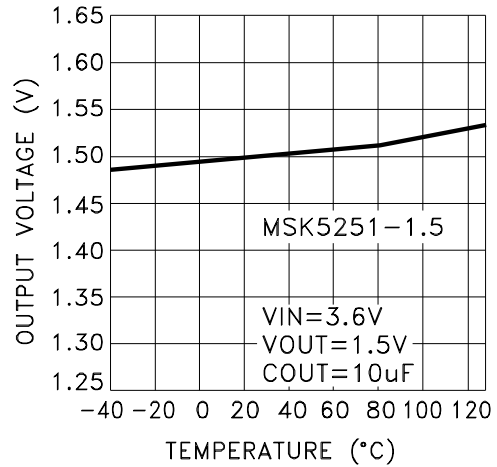

CURRENT LIMIT vs INPUT VOLTAGE

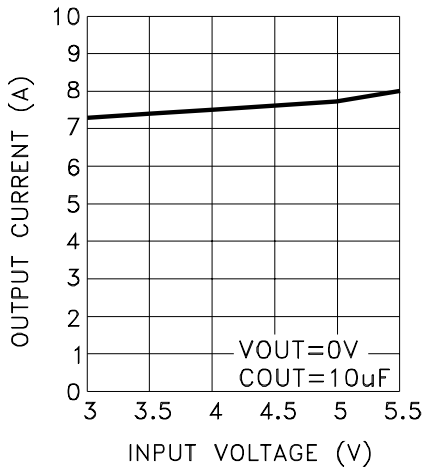

TURN-ON TIME

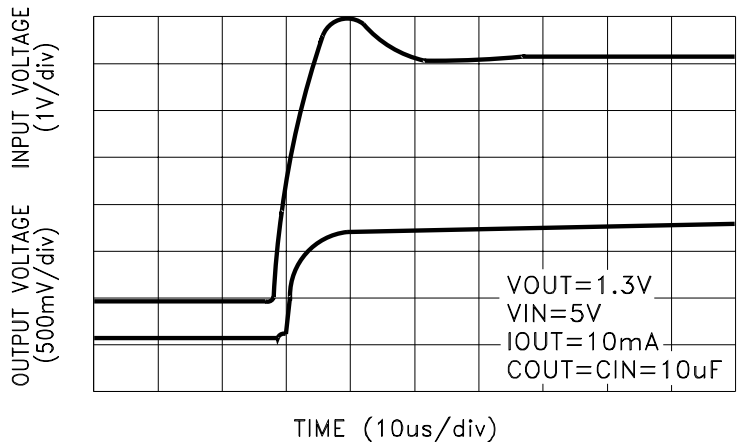

LOAD TRANSIENT

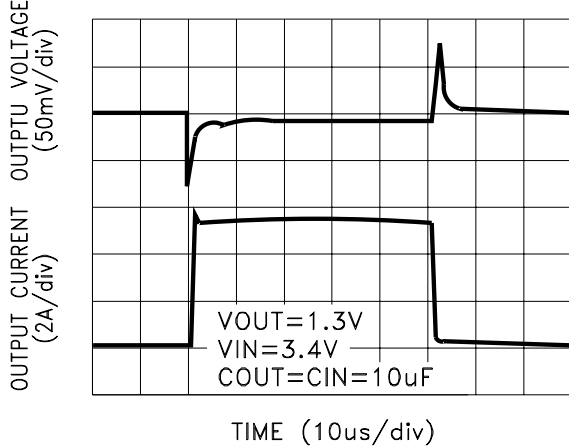

LINE TRANSIENT

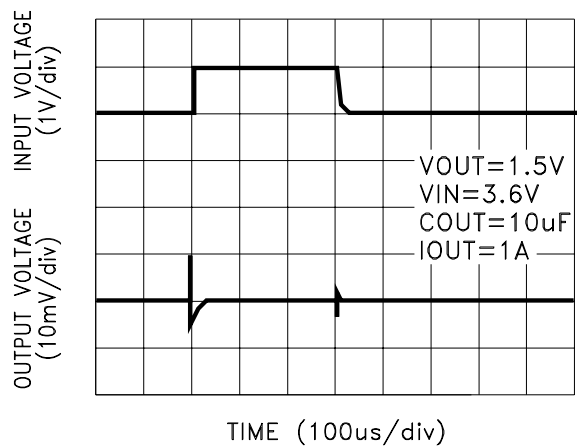

## MECHANICAL SPECIFICATIONS

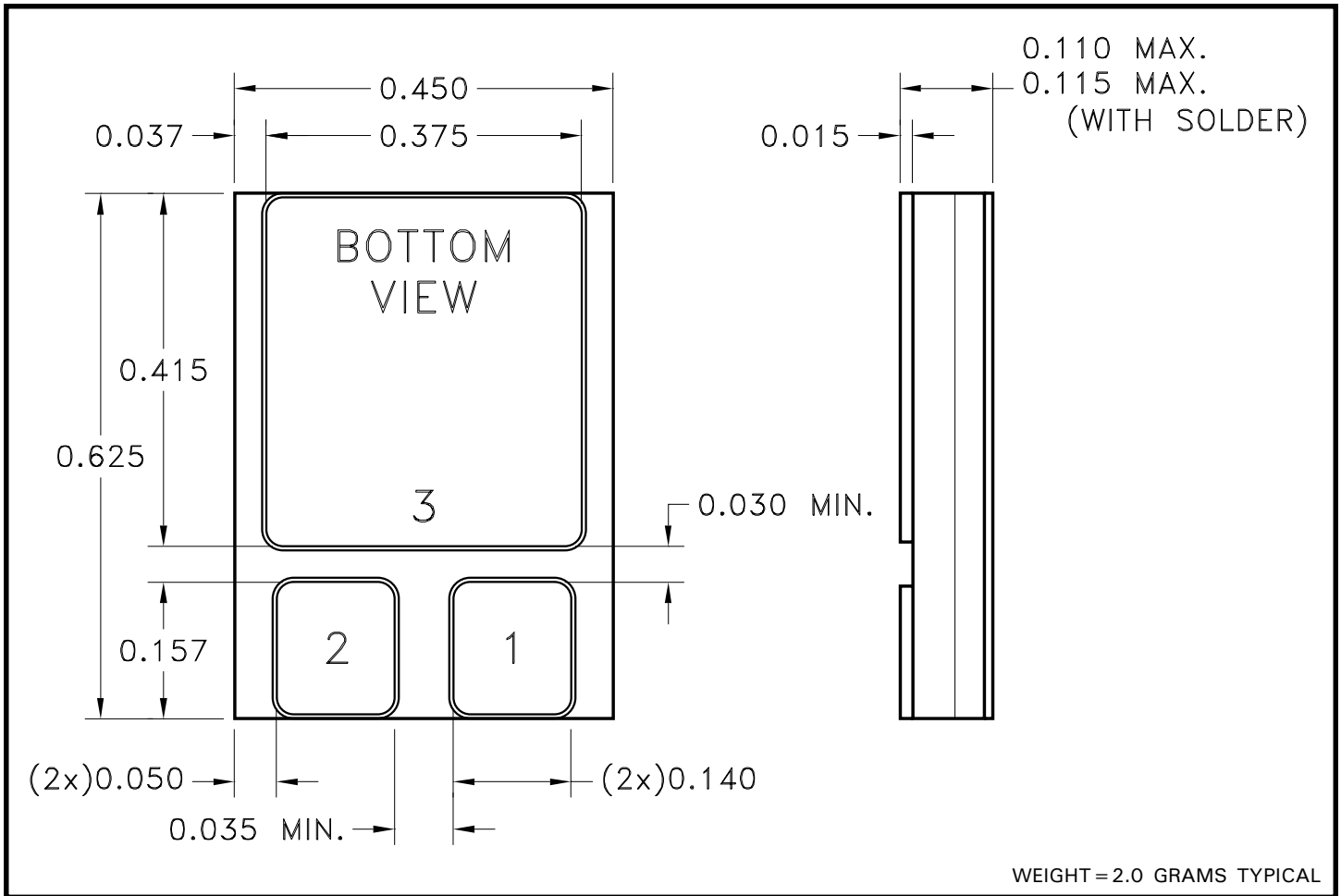

NOTE: ALL DIMENSIONS ARE  $\pm 0.010$  INCHES UNLESS OTHERWISE LABELED.

## ORDERING INFORMATION

**MSK5251-1.3 H**

**SCREENING**

BLANK = INDUSTRIAL; E = EXTENDED RELIABILITY  
H = MIL-PRF-38534 CLASS H

**OUTPUT VOLTAGE**

0.8 = +0.8V; 0.9 = +0.9V; 1.0 = +1.0V; 1.2 = +1.2V;  
1.3 = +1.3V; 1.5 = +1.5V

**GENERAL PART NUMBER**

The above example is a +1.3V, Military regulator.

**M.S. Kennedy Corp.**

4707 Dey Road, Liverpool, New York 13088

Phone (315) 701-6751

FAX (315) 701-6752

[www.mskennedy.com](http://www.mskennedy.com)

The information contained herein is believed to be accurate at the time of printing. MSK reserves the right to make changes to its products or specifications without notice, however, and assumes no liability for the use of its products.

Please visit our website for the most recent revision of this datasheet.

Contact MSK for MIL-PRF-38534 qualification status.