

DESCRIPTION

The AMC7637 is an ultra low quiescent current, and low dropout regulator rated for 300mA output current. The low power consumption and high accuracy is achieved through CMOS technology and internal trimmed reference voltage.

The AMC7637 consists of a high-precision voltage reference, error correction circuit, and a current limit output driver. The fast transient response is an outstanding feature for applications with various loads.

FEATURES

- Ultra low quiescent current of 15 μ A in typical.
- Typical 2% internally trimmed output.
- Output current is excess of 300mA.
- Low Dropout Voltage.
- P-MOS output stage with low $R_{DS(ON)}$.
- Short circuit protection.
- Internal thermal overload protection.
- Available in 3-Lead surface mount SOT-23 package.

TYPICAL APPLICATION

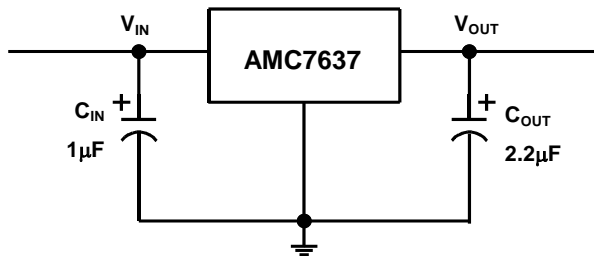

APPLICATIONS

- Digital Camera
- Battery Powered Applications
- PDA
- Smart Phones

VOLTAGE OPTIONS

AMC7637-1.5	1.5V Fixed
AMC7637-1.8	1.8V Fixed
AMC7637-2.5	2.5V Fixed
AMC7637-3.0	3.0V Fixed
AMC7637-3.3	3.3V Fixed

PACKAGE PIN OUT

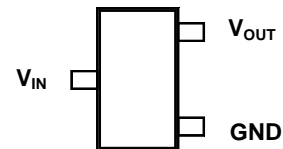

**3-Pin Plastic SOT-23
Surface Mount**

ORDER INFORMATION

T_A (°C)	DB	SOT-23
		3-pin
-40 to +85	AMC7637-X.XDBF (Lead Free)	
<p>Note: 1. All surface-mount packages are available in Tape & Reel. Append the letter "T" to part number (i.e. AMC7637-X.XDBFT).</p> <p>Note: 2. The letter "F" is marked for Lead Free process.</p>		

ABSOLUTE MAXIMUM RATINGS (Note)

Input Voltage, V_{IN}	8V
Maximum Operating Junction Temperature, T_J	150°C
Storage Temperature Range	-65°C to 150°C
Lead Temperature (soldering, 10 seconds)	260°C

Note: Exceeding these ratings could cause damage to the device. All voltages are with respect to Ground.
Currents are positive into, negative out of the specified terminal.

THERMAL DATA

Thermal Resistance from Junction to Ambient, θ_{JA}	250°C/W
--	---------

Junction Temperature Calculation: $T_J = T_A + (P_D \times \theta_{JA})$.
The θ_{JA} numbers are guidelines for the thermal performance of the device/pc-board system.
Connect the ground pin to ground using a large pad or ground plane for better heat dissipation.
All of the above assume no ambient airflow.

Maximum Power Calculation:

$$P_{D(MAX)} = \frac{T_{J(MAX)} - T_{A(MAX)}}{\theta_{JA}}$$

T_J (°C): Maximum recommended junction temperature

T_A (°C): Ambient temperature of the application

θ_{JA} (°C/W): Junction-to-Ambient temperature thermal resistance of the package, and other heat dissipating materials.

The maximum power dissipation for a single-output regulator is:

$$P_{D(MAX)} = [(V_{IN(MAX)} - V_{OUT(NOM)}) \times I_{OUT(NOM)} + V_{IN(MAX)} \times I_Q]$$

Where: $V_{OUT(NOM)}$ = the nominal output voltage

$I_{OUT(NOM)}$ = the nominal output current, and

I_Q = the quiescent current the regulator consumes at $I_{OUT(MAX)}$

$V_{IN(MAX)}$ = the maximum input voltage

Then $\theta_{JA} = (125^\circ\text{C} - T_A) / P_D$

BLOCK DIAGRAM

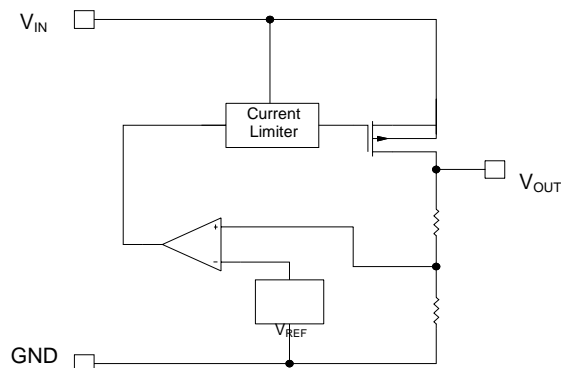

RECOMMENDED OPERATING CONDITIONS

Parameter	Symbol	Min.	Typ.	Max.	Units
Input Voltage	V_{IN}	NOTE		7	V
Load Current (with adequate heat sinking)	I_O	5		300	mA
Input Capacitor (V_{IN} to GND)		0.1			μ F
Output Capacitor with ESR of 10 Ω max. (V_{OUT} to GND)		1.0			μ F
Operating ambient temperature range	T_A	-40		85	$^{\circ}$ C
Operating junction temperature	T_J			125	$^{\circ}$ C

Note : $V_{IN(MIN)} = V_{OUT} + V_{DROP}$

ELECTRICAL CHARACTERISTICS

Unless otherwise specified, $V_{IN} = V_{O(TYP)} + 1V$, $I_O = 10mA$, $C_{OUT} = 2.2\mu F$, $T_A = 25^{\circ}C$, and are for DC characteristics only. (Low duty cycle pulse testing techniques are used which maintains junction and case temperatures equal to the ambient temperature.)

Parameter	Symbol	Conditions	Min	Typ	Max	Units
Output Voltage Accuracy	V_O	$I_O = 10mA$	-2		+2	%
Line Regulation	ΔV_{OI}	$V_{IN} = (V_O + 0.5V)$ to 8V		0.1	0.3	%/V
Load Regulation	ΔV_{OL}	$10mA \leq I_O \leq 100mA$		15	30	mV
		$10mA \leq I_O \leq 300mA$		45	80	
Dropout Voltage	V_{DROP}	$I_O = 100mA$ $V_O = V_{O(NOM)} - 2.0\%$	$V_{O(NOM)} \leq 2.0V$		300	mV
			$2.0V < V_{O(NOM)}$		200	
		$I_O = 300mA$ $V_O = V_{O(NOM)} - 2.0\%$	$1.3V \leq V_{O(NOM)} \leq 2.0V$		1300	
			$2.0V < V_{O(NOM)} \leq 2.8V$		600	
		$2.8 < V_{O(NOM)}$		500		
Ground Pin Current	I_Q	$I_O = 10mA \sim 300mA$		15	30	μ A
Current Limit	I_{CL}	$V_{IN} = V_{OUT} + 0.5V$	350			mA
Output Voltage Temperature Coefficient		$I_O = 100mA$, $-40^{\circ}C \leq T_J \leq 125^{\circ}C$		± 100		ppm/ $^{\circ}C$

CHARACTERIZATION CURVES

$V_{IN} = 5V$, $C_{IN} = 1\mu F$, $C_{OUT} = 2.2\mu F$, $T_A = 25^\circ C$ unless otherwise specified.

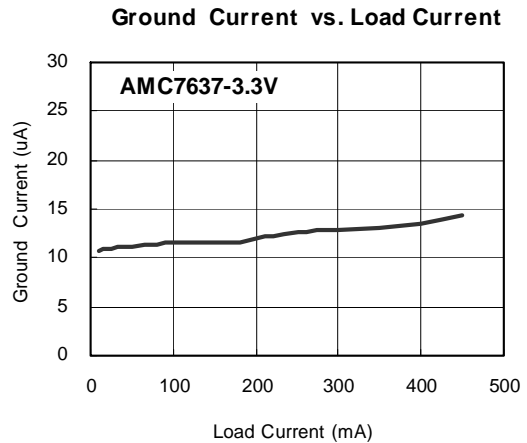
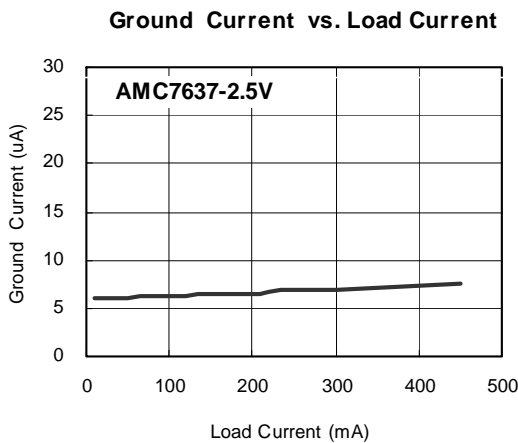
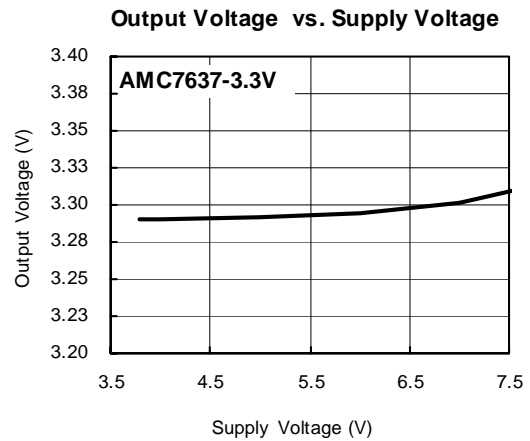
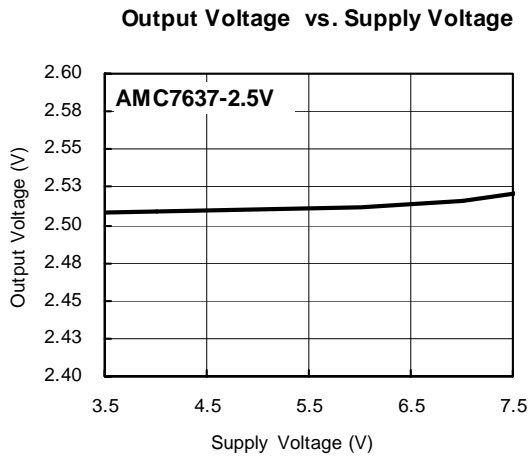
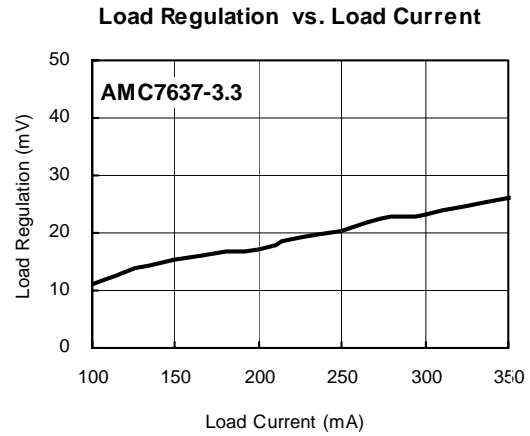
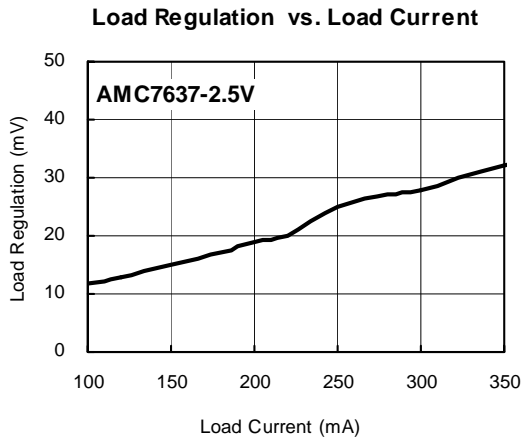

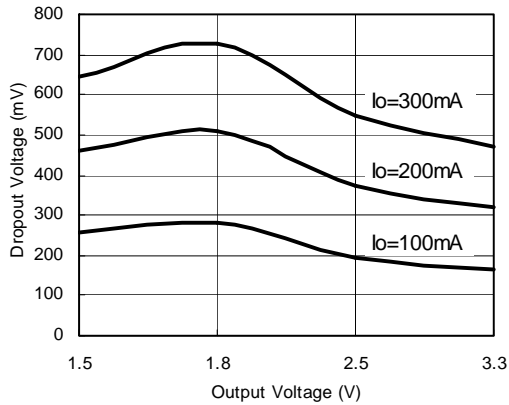
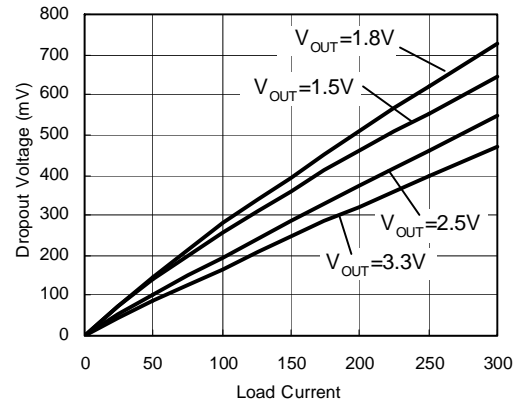
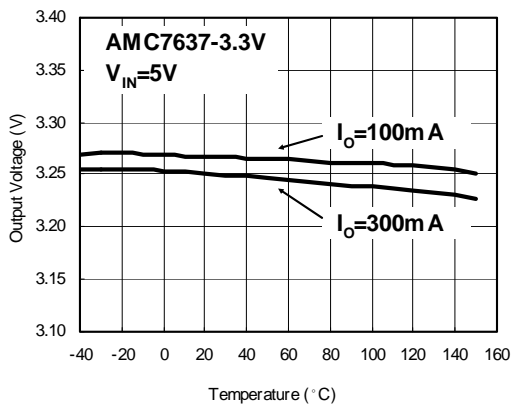
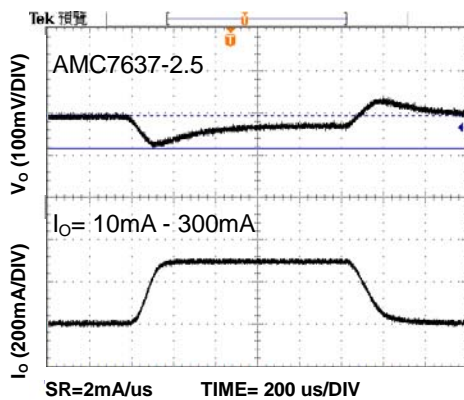
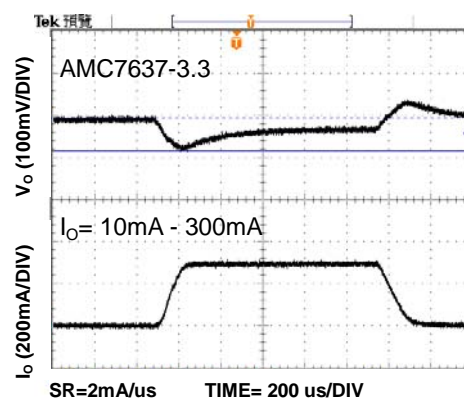
Dropout Voltage vs. Output Voltage

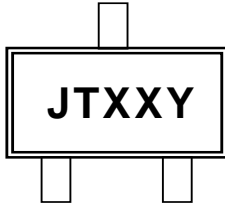
Dropout Voltage vs. Load Current

Output Voltage vs. Temperature

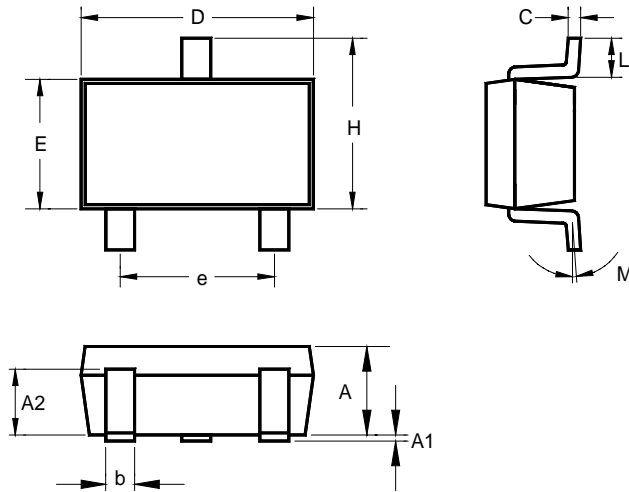
Load Transient Response
 $V_{IN}=5V, C_{IN}=1\mu F, C_{OUT}=2.2\mu F, T_A=25^\circ C$

Load Transient Response
 $V_{IN}=5V, C_{IN}=1\mu F, C_{OUT}=2.2\mu F, T_A=25^\circ C$

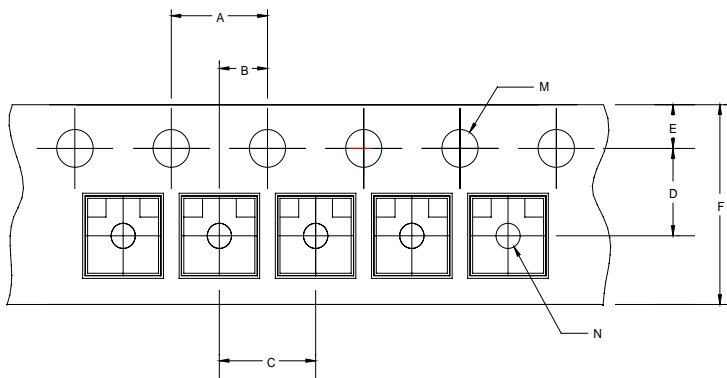
PACKAGE
Symbol

XX: Output Voltage Options

15 = 1.5V, 18 = 1.8V, 25 = 2.5V, 30 = 3.0V, 33 = 3.3V

Y: A/T Site
Surface Mount SOT-23

	INCHES			MILLIMETERS		
	MIN	TYP	MAX	MIN	TYP	MAX
A	0.039	0.043	0.051	1.00	1.10	1.30
A1	0.000	-	0.004	0.00	-	0.10
A2	0.028	0.032	0.035	0.70	0.80	0.90
b	0.014	0.016	0.020	0.35	0.40	0.50
C	0.004	0.005	0.010	0.10	0.15	0.25
D	0.106	0.114	0.122	2.70	2.90	3.10
E	0.055	0.063	0.071	1.40	1.60	1.80
e	0.075 TYP.			1.90 TYP.		
H	0.102	0.110	0.118	2.60	2.80	3.00
L	0.015	-	-	0.37	-	-
M	1°	5°	9°	1°	5°	9°

Surface Mount SOT-23 Carrier Dimensions

MILLIMETERS			
A	4.0 ± 0.1	M	1.5 ± 0.1
B	2.0 ± 0.05	N	1.1 ± 0.1
C	4.0 ± 0.1		
D	2.5 ± 0.05		
E	1.75 ± 0.1		
F	6.0 ± 0.2		

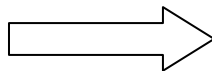
DIRECTION OF FEED

IMPORTANT NOTICE

ADDtek reserves the right to make changes to its products or to discontinue any integrated circuit product or service without notice, and advises its customers to obtain the latest version of relevant information to verify, before placing orders, that the information being relied on is current.

A few applications using integrated circuit products may involve potential risks of death, personal injury, or severe property or environmental damage. ADDtek integrated circuit products are not designed, intended, authorized, or warranted to be suitable for use in life-support applications, devices or systems or other critical applications. Use of ADDtek products in such applications is understood to be fully at the risk of the customer. In order to minimize risks associated with the customer's applications, the customer should provide adequate design and operating safeguards.

ADDtek assumes no liability to customer product design or application support. ADDtek warrants the performance of its products to the specifications applicable at the time of sale.

ADDtek Corp.

9F, No. 20, Sec. 3, Bade Rd., Taipei, Taiwan, 105

TEL: 2-25700299

FAX: 2-25700196
