

Silicon NPN Planar RF Transistor

Features

- High power gain
- Low noise figure
- High transition frequency

Applications

RF amplifier up to GHz range.

Mechanical Data

Typ: BFP93A

Case: SOT-143 Plastic case

Weight: approx. 8.0 mg

Marking: FE

Pinning:

1 = Collector, 2 = Emitter

3 = Base, 4 = Emitter

Typ: BFP93AW

Case: SOT-343 Plastic case

Weight: approx. 6.0 mg

Marking: WFE

Pinning:

1 = Collector, 2 = Emitter,

3 = Base, 4 = Emitter

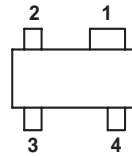

SOT-143

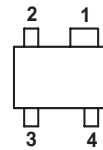
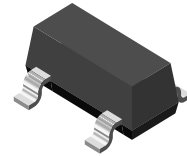

SOT-343

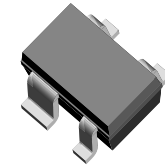

Electrostatic sensitive device.

Observe precautions for handling.

13579

Absolute Maximum Ratings

$T_{amb} = 25\text{ }^{\circ}\text{C}$, unless otherwise specified

Parameter	Test condition	Symbol	Value	Unit
Collector-base voltage		V_{CBO}	20	V
Collector-emitter voltage		V_{CEO}	12	V
Emitter-base voltage		V_{EBO}	2	V
Collector current		I_C	50	mA
Total power dissipation	$T_{amb} \leq 60\text{ }^{\circ}\text{C}$	P_{tot}	200	mW
Junction temperature		T_j	150	$^{\circ}\text{C}$
Storage temperature range		T_{stg}	-65 to +150	$^{\circ}\text{C}$

Maximum Thermal Resistance

Parameter	Test condition	Symbol	Value	Unit
Junction ambient	¹⁾	R_{thJA}	450	K/W

¹⁾ on glass fibre printed board (25 x 20 x 1.5) mm³ plated with 35 μm Cu

Electrical DC Characteristics

$T_{amb} = 25\text{ }^{\circ}\text{C}$, unless otherwise specified

Parameter	Test condition	Symbol	Min	Typ.	Max	Unit
Collector-emitter cut-off current	$V_{CE} = 20\text{ V}$, $V_{BE} = 0$	I_{CES}			100	μA
Collector-base cut-off current	$V_{CB} = 15\text{ V}$, $I_E = 0$	I_{CBO}			100	nA
Emitter-base cut-off current	$V_{EB} = 2\text{ V}$, $I_C = 0$	I_{EBO}			10	μA
Collector-emitter breakdown voltage	$I_C = 1\text{ mA}$, $I_B = 0$	$V_{(BR)CEO}$	12			V
Collector-emitter saturation voltage	$I_C = 50\text{ mA}$, $I_B = 5\text{ mA}$	V_{CEsat}		0.1	0.4	V
DC forward current transfer ratio	$V_{CE} = 5\text{ V}$, $I_C = 30\text{ mA}$	h_{FE}	40	90	150	

Electrical AC Characteristics

$T_{amb} = 25\text{ }^{\circ}\text{C}$, unless otherwise specified

Parameter	Test condition	Symbol	Min	Typ.	Max	Unit
Transition frequency	$V_{CE} = 5\text{ V}$, $I_C = 30\text{ mA}$, $f = 500\text{ MHz}$	f_T		6		GHz
Collector-base capacitance	$V_{CB} = 10\text{ V}$, $f = 1\text{ MHz}$	C_{cb}		0.45		pF
Collector-emitter capacitance	$V_{CE} = 10\text{ V}$, $f = 1\text{ MHz}$	C_{ce}		0.2		pF
Emitter-base capacitance	$V_{EB} = 0.5\text{ V}$, $f = 1\text{ MHz}$	C_{eb}		1.25		pF
Noise figure	$V_{CE} = 8\text{ V}$, $Z_S = 50\ \Omega$, $f = 800\text{ MHz}$, $I_C = 5\text{ mA}$	F		1.6		dB
	$V_{CE} = 8\text{ V}$, $Z_S = 50\ \Omega$, $f = 800\text{ MHz}$, $I_C = 25\text{ mA}$	F		2.1		dB
Power gain	$V_{CE} = 8\text{ V}$, $Z_S = 50\ \Omega$, $Z_L = Z_{Lopt}$, $I_C = 25\text{ mA}$, $f = 800\text{ MHz}$	G_{pe}		17		dB
	$V_{CE} = 8\text{ V}$, $Z_S = 50\ \Omega$, $Z_L = Z_{Lopt}$, $I_C = 25\text{ mA}$, $f = 2\text{ GHz}$	G_{pe}		10		dB
Linear output voltage - two tone intermodulation test	$V_{CE} = 8\text{ V}$, $I_C = 25\text{ mA}$, $d_{IM} = 60\text{ dB}$, $f_1 = 806\text{ MHz}$, $f_2 = 810\text{ MHz}$, $Z_S = Z_L = 50\ \Omega$	$V_1 = V_2$		260		mV
Third order intercept point	$V_{CE} = 8\text{ V}$, $I_C = 25\text{ mA}$, $f = 800\text{ MHz}$	IP_3		31		dBm



Common Emitter S-Parameters

$Z_0 = 50 \Omega$, $T_{amb} = 25^\circ\text{C}$, unless otherwise specified

V_{CE}/V	I_C/mA	f/MHz	S11		S21		S12		S22	
			LIN MAG	ANG	LIN MAG	ANG	LIN MAG	ANG	LIN MAG	ANG
				deg		deg		deg		deg
3	10	100	0.642	-64.0	22.49	143.1	0.026	61.3	0.797	-31.5
		300	0.566	-130.1	12.29	109.6	0.045	43.5	0.433	-52.7
		500	0.555	-156.2	8.00	95.5	0.053	42.7	0.293	-54.6
		800	0.560	-176.6	5.25	82.4	0.066	45.5	0.221	-52.7
		1000	0.567	173.8	4.30	75.8	0.075	46.6	0.204	-52.6
		1200	0.580	166.3	3.64	69.3	0.085	47.0	0.192	-54.2
		1500	0.601	156.6	2.97	60.2	0.099	46.6	0.181	-60.0
		1800	0.620	148.0	2.52	52.1	0.112	45.6	0.171	-68.0
		2000	0.642	143.3	2.30	46.6	0.122	44.6	0.170	-74.4
		2200	0.662	137.5	2.13	41.5	0.132	43.5	0.169	-79.8
		2500	0.691	130.2	1.90	33.4	0.143	37.9	0.168	-92.4
		2800	0.715	123.1	1.70	25.9	0.152	37.7	0.176	-104.2
		3000	0.733	119.4	1.59	21.6	0.160	36.4	0.180	-112.7
3	30	100	0.486	-114.2	34.23	127.8	0.017	56.0	0.600	-48.7
		300	0.552	-162.2	14.56	99.7	0.029	55.0	0.248	-67.8
		500	0.563	-177.2	9.10	89.1	0.040	59.7	0.149	-66.7
		800	0.572	169.7	5.84	78.5	0.058	62.0	0.105	-59.3
		1000	0.578	162.6	4.75	72.6	0.071	61.4	0.098	-57.0
		1200	0.590	157.0	4.01	67.0	0.084	60.0	0.093	-58.5
		1500	0.609	149.7	3.25	58.4	0.101	57.5	0.090	-67.5
		1800	0.631	142.5	2.76	51.0	0.117	54.4	0.086	-80.2
		2000	0.649	138.7	2.50	45.9	0.129	52.1	0.089	-90.0
		2200	0.673	133.3	2.31	41.0	0.140	50.0	0.091	-97.4
		2500	0.698	126.9	2.06	33.3	0.151	43.7	0.099	-116.4
		2800	0.718	120.6	1.84	26.5	0.162	42.2	0.112	-129.8
		3000	0.736	116.6	1.72	21.9	0.169	40.3	0.124	-138.5
5	10	100	0.658	-59.4	22.80	144.7	0.024	62.3	0.816	-28.2
		300	0.557	-125.3	12.81	111.0	0.042	44.4	0.468	-46.6
		500	0.538	-152.8	8.42	96.6	0.050	43.3	0.331	-46.8
		800	0.543	-174.4	5.51	83.3	0.062	45.8	0.263	-44.0
		1000	0.546	175.6	4.50	76.6	0.071	47.4	0.248	-43.8
		1200	0.561	167.7	3.82	70.2	0.080	47.6	0.237	-45.1
		1500	0.578	157.8	3.12	61.1	0.093	47.4	0.225	-50.0
		1800	0.601	149.0	2.65	53.2	0.105	46.7	0.215	-56.5
		2000	0.623	143.9	2.41	47.7	0.115	46.0	0.213	-61.8
		2200	0.640	138.2	2.23	42.6	0.124	45.0	0.211	-66.5
		2500	0.673	131.0	1.99	34.7	0.136	39.4	0.206	-77.4
		2800	0.696	123.9	1.79	27.0	0.144	39.3	0.208	-87.9
		3000	0.709	119.6	1.68	22.7	0.151	38.0	0.208	-95.7
5	30	100	0.483	-104.7	35.46	129.2	0.016	57.3	0.625	-43.0

BFP93A / BFP93AW



Vishay Semiconductors

V _{CE} /V	I _C /mA	f/MHz	S11		S21		S12		S22	
			LIN MAG	ANG deg	LIN MAG	ANG deg	LIN MAG	ANG deg	LIN MAG	ANG deg
		300	0.519	-157.7	15.38	100.3	0.028	55.0	0.276	-54.3
		500	0.525	-174.0	9.63	89.2	0.039	59.2	0.184	-47.0
		800	0.531	172.2	6.21	78.4	0.057	61.3	0.153	-36.7
		1000	0.527	165.0	5.05	72.5	0.069	60.9	0.151	-34.6
		1200	0.534	159.5	4.28	66.5	0.081	59.4	0.149	-35.2
		1500	0.547	151.1	3.50	57.7	0.099	56.3	0.145	-40.7
		1800	0.561	143.1	2.98	49.8	0.115	52.8	0.138	-48.2
		2000	0.570	138.1	2.72	44.2	0.127	50.3	0.138	-55.2
		2200	0.587	131.9	2.53	38.9	0.139	47.9	0.139	-60.9
		2500	0.601	123.8	2.27	30.1	0.154	40.8	0.129	-75.2
		2800	0.619	114.4	2.07	22.3	0.165	38.4	0.136	-87.8
3000	0.628	108.4	1.95	17.2	0.174	35.4	0.140	-98.5		
8	5	100	0.807	-37.8	14.08	154.2	0.026	69.9	0.906	-17.3
		300	0.646	-94.1	9.77	121.8	0.054	45.8	0.656	-33.8
		500	0.573	-126.8	6.93	104.3	0.065	37.9	0.510	-37.1
		800	0.549	-155.7	4.70	88.5	0.073	34.7	0.423	-38.2
		1000	0.544	-168.8	3.89	80.8	0.078	34.4	0.399	-39.0
		1200	0.555	-179.3	3.32	73.5	0.083	34.8	0.382	-40.7
		1500	0.572	168.6	2.73	63.6	0.090	35.3	0.367	-44.7
		1800	0.591	157.8	2.34	55.0	0.098	36.3	0.356	-50.2
		2000	0.613	151.4	2.14	49.1	0.104	36.3	0.352	-54.5
		2200	0.631	144.3	1.98	43.5	0.110	36.3	0.349	-58.4
		2500	0.649	135.2	1.77	35.2	0.119	35.8	0.347	-65.3
		2800	0.677	126.9	1.60	27.3	0.126	35.7	0.351	-74.6
3000	0.695	122.6	1.50	22.8	0.132	34.9	0.345	-80.8		
8	10	100	0.687	-54.7	22.73	146.0	0.023	63.5	0.827	-25.9
		300	0.551	-119.4	13.13	112.3	0.041	45.2	0.494	-42.9
		500	0.520	-148.4	8.68	97.3	0.048	43.8	0.360	-42.5
		800	0.519	-171.6	5.70	84.0	0.061	46.1	0.294	-39.8
		1000	0.523	178.3	4.66	77.3	0.069	47.2	0.279	-39.7
		1200	0.534	170.0	3.95	70.8	0.078	47.5	0.268	-40.9
		1500	0.551	159.6	3.22	61.7	0.091	47.3	0.255	-45.3
		1800	0.575	151.4	2.74	53.8	0.103	46.2	0.244	-51.4
		2000	0.598	146.1	2.50	48.3	0.112	45.6	0.241	-56.3
		2200	0.617	140.0	2.31	43.1	0.120	44.6	0.238	-60.4
		2500	0.641	132.3	2.06	35.2	0.133	39.4	0.231	-69.9
		2800	0.672	125.4	1.84	27.8	0.139	39.1	0.231	-79.7
3000	0.687	121.6	1.73	23.4	0.146	37.9	0.226	-87.0		
8	15	100	0.606	-68.3	28.45	140.3	0.020	60.8	0.764	-31.7



BFP93A / BFP93AW

Vishay Semiconductors

V _{CE} /V	I _C /mA	f/MHz	S11		S21		S12		S22	
			LIN	ANG	LIN	ANG	LIN	ANG	LIN	ANG
			MAG	deg	MAG	deg	MAG	deg	MAG	deg
		300	0.520	-133.8	14.66	107.5	0.035	47.7	0.408	-47.2
		500	0.506	-158.7	9.43	94.2	0.043	49.1	0.289	-44.5
		800	0.510	-178.4	6.13	82.1	0.057	52.6	0.236	-39.7
		1000	0.515	172.5	5.00	75.8	0.067	53.5	0.227	-39.2
		1200	0.530	165.1	4.22	69.8	0.077	53.4	0.219	-40.0
		1500	0.550	156.5	3.43	61.0	0.092	52.2	0.209	-44.9
		1800	0.573	148.2	2.91	53.5	0.106	50.0	0.199	-51.5
		2000	0.586	143.5	2.65	48.1	0.115	48.9	0.196	-56.8
		2200	0.614	137.7	2.44	43.2	0.125	47.7	0.194	-61.1
		2500	0.644	131.1	2.19	35.4	0.138	41.1	0.185	-72.6
		2800	0.667	124.1	1.95	28.2	0.144	41.0	0.186	-82.7
3000	0.680	120.2	1.84	24.2	0.152	39.5	0.184	-90.8		
8	20	100	0.558	-79.5	32.26	136.2	0.018	58.5	0.714	-35.7
		300	0.509	-143.1	15.46	104.7	0.031	50.3	0.356	-49.4
		500	0.502	-165.3	9.81	92.4	0.040	53.3	0.249	-45.3
		800	0.511	177.7	6.33	81.0	0.056	56.7	0.205	-39.0
		1000	0.517	169.2	5.16	75.1	0.067	57.0	0.199	-38.1
		1200	0.527	162.4	4.36	69.1	0.077	56.6	0.193	-39.2
		1500	0.546	154.4	3.54	60.7	0.092	55.0	0.184	-44.5
		1800	0.568	146.5	2.99	53.1	0.107	52.3	0.175	-51.6
		2000	0.591	142.2	2.73	48.1	0.117	50.9	0.173	-57.2
		2200	0.610	136.8	2.51	43.0	0.127	49.2	0.170	-61.9
		2500	0.639	130.4	2.24	35.5	0.140	42.4	0.163	-74.8
		2800	0.665	123.2	2.01	28.5	0.147	42.1	0.164	-85.2
3000	0.684	119.9	1.89	24.5	0.154	40.5	0.162	-94.3		
8	25	100	0.525	-88.2	34.79	133.1	0.017	58.0	0.676	-38.5
		300	0.505	-148.9	15.91	102.8	0.029	52.5	0.322	-50.8
		500	0.503	-168.8	10.01	91.2	0.039	56.3	0.224	-45.2
		800	0.511	175.1	6.43	80.2	0.055	59.3	0.187	-37.0
		1000	0.518	167.2	5.24	74.3	0.066	59.5	0.183	-36.9
		1200	0.528	161.0	4.42	68.6	0.078	58.4	0.178	-38.2
		1500	0.548	153.2	3.59	60.3	0.093	56.3	0.170	-43.7
		1800	0.571	145.9	3.03	52.9	0.108	53.6	0.161	-51.2
		2000	0.585	141.5	2.76	47.8	0.118	51.8	0.159	-57.3
		2200	0.613	136.0	2.55	43.1	0.128	50.0	0.157	-62.1
		2500	0.642	129.6	2.27	35.3	0.141	43.4	0.150	-75.7
		2800	0.669	122.7	2.04	28.5	0.148	42.7	0.151	-86.7
3000	0.683	119.4	1.91	24.2	0.156	40.9	0.151	-96.2		
8	30	100	0.507	-95.1	36.47	130.8	0.016	57.9	0.644	-46.6

V_{CE}/V	I_C/mA	f/MHz	S11		S21		S12		S22	
			LIN MAG	ANG	LIN MAG	ANG	LIN MAG	ANG	LIN MAG	ANG
				deg		deg		deg		deg
		300	0.506	-153.1	16.13	101.4	0.027	54.4	0.299	-51.2
		500	0.506	-171.5	10.10	90.4	0.036	58.7	0.208	-44.5
		800	0.515	173.2	6.48	79.6	0.055	61.1	0.176	-36.7
		1000	0.523	166.1	5.28	74.0	0.066	60.9	0.173	-35.7
		1200	0.531	159.9	4.45	68.2	0.077	60.0	0.169	-37.0
		1500	0.551	152.4	3.60	59.9	0.093	57.4	0.162	-42.7
		1800	0.574	145.2	3.05	52.7	0.108	54.4	0.154	-50.8
		2000	0.585	141.0	2.76	47.4	0.119	52.6	0.152	-56.9
		2200	0.613	135.7	2.57	42.8	0.128	50.8	0.150	-62.0
		2500	0.644	129.2	2.28	35.1	0.141	43.9	0.143	-76.2
		2800	0.669	122.8	2.04	28.5	0.149	43.2	0.145	-87.6
		3000	0.685	119.2	1.91	24.2	0.156	41.4	0.144	-97.7

Typical Characteristics ($T_{amb} = 25\text{ }^\circ\text{C}$ unless otherwise specified)

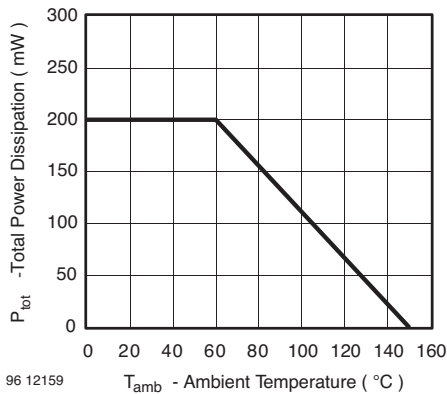

Figure 1. Total Power Dissipation vs. Ambient Temperature

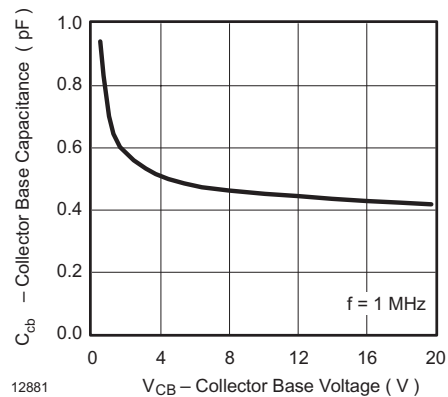

Figure 3. Collector Base Capacitance vs. Collector Base Voltage

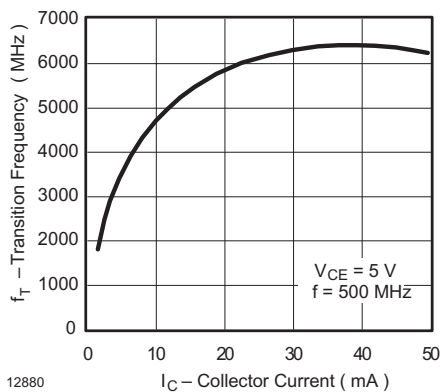

Figure 2. Transition Frequency vs. Collector Current

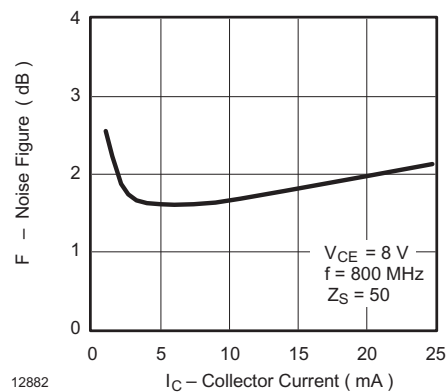
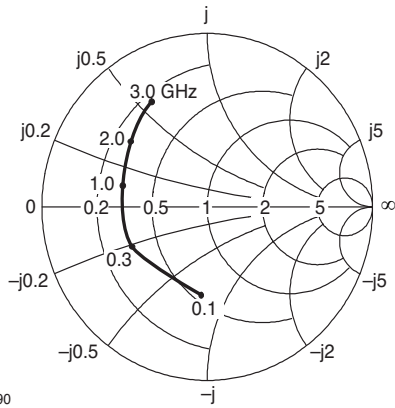

Figure 4. Noise Figure vs. Collector Current

$V_{CE} = 8\text{ V}$, $I_C = 30\text{ mA}$, $Z_0 = 50\ \Omega$

S_{11}



12990

Figure 5. Input Reflection Coefficient

S_{21}

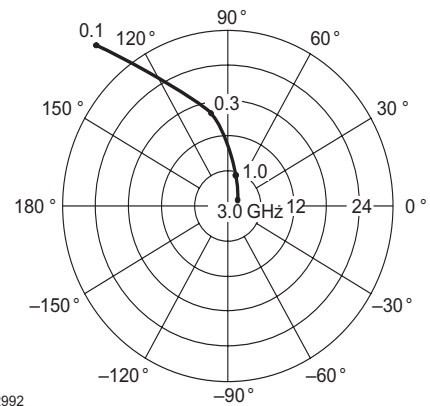

12992

Figure 7. Forward Transmission Coefficient

S_{12}

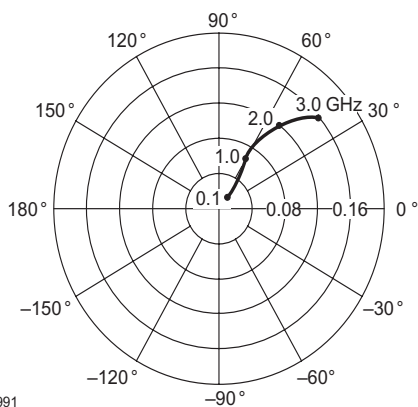

12991

Figure 6. Reverse Transmission Coefficient

S_{22}

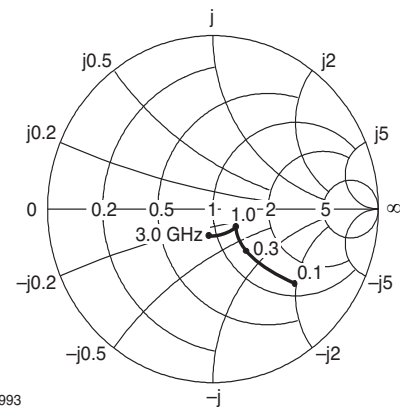

12993

Figure 8. Output Reflection Coefficient

BFP93A / BFP93AW



Vishay Semiconductors

Package Dimensions in mm

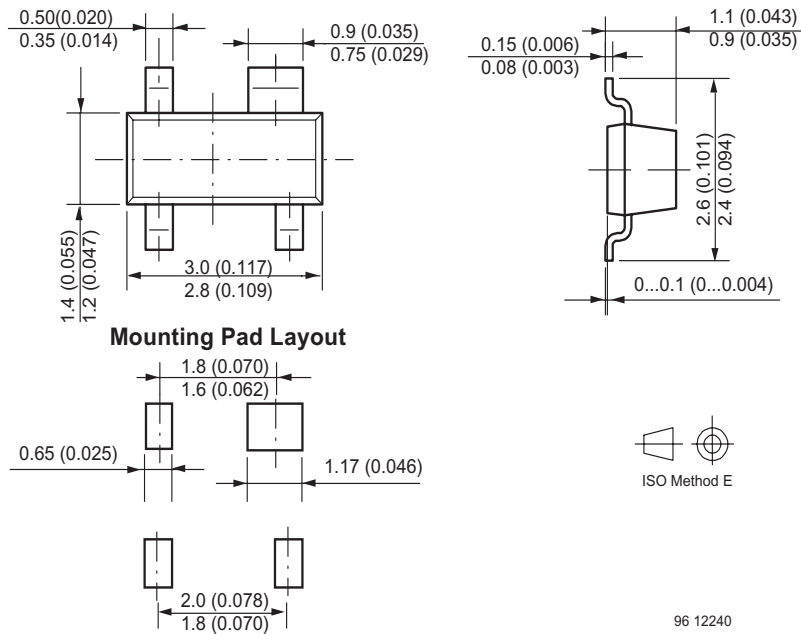

Package Dimensions in mm

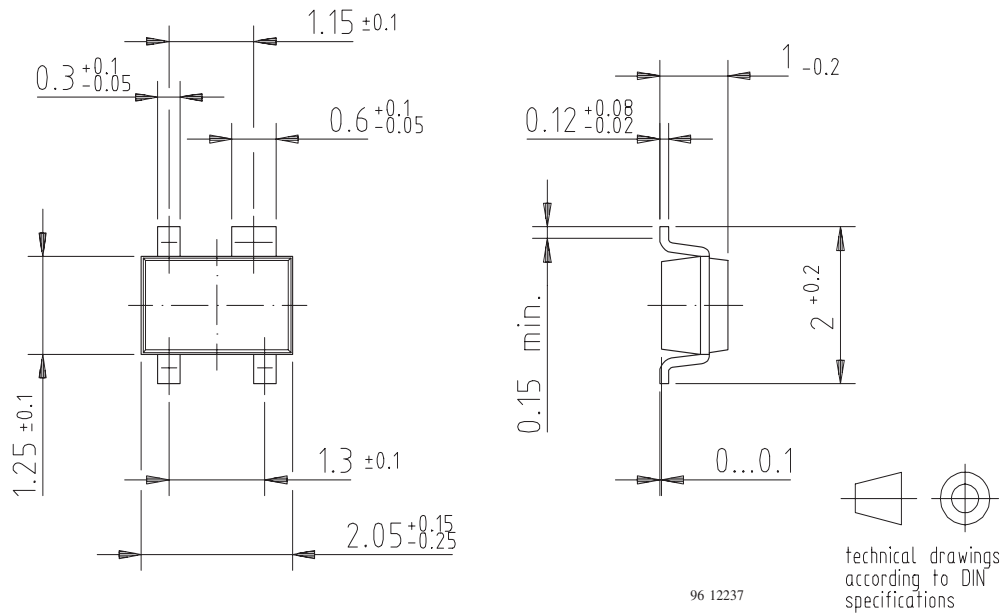



Ozone Depleting Substances Policy Statement

It is the policy of **Vishay Semiconductor GmbH** to

1. Meet all present and future national and international statutory requirements.
2. Regularly and continuously improve the performance of our products, processes, distribution and operating systems with respect to their impact on the health and safety of our employees and the public, as well as their impact on the environment.

It is particular concern to control or eliminate releases of those substances into the atmosphere which are known as ozone depleting substances (ODSs).

The Montreal Protocol (1987) and its London Amendments (1990) intend to severely restrict the use of ODSs and forbid their use within the next ten years. Various national and international initiatives are pressing for an earlier ban on these substances.

Vishay Semiconductor GmbH has been able to use its policy of continuous improvements to eliminate the use of ODSs listed in the following documents.

1. Annex A, B and list of transitional substances of the Montreal Protocol and the London Amendments respectively
2. Class I and II ozone depleting substances in the Clean Air Act Amendments of 1990 by the Environmental Protection Agency (EPA) in the USA
3. Council Decision 88/540/EEC and 91/690/EEC Annex A, B and C (transitional substances) respectively.

Vishay Semiconductor GmbH can certify that our semiconductors are not manufactured with ozone depleting substances and do not contain such substances.

**We reserve the right to make changes to improve technical design
and may do so without further notice.**

Parameters can vary in different applications. All operating parameters must be validated for each customer application by the customer. Should the buyer use Vishay Semiconductors products for any unintended or unauthorized application, the buyer shall indemnify Vishay Semiconductors against all claims, costs, damages, and expenses, arising out of, directly or indirectly, any claim of personal damage, injury or death associated with such unintended or unauthorized use.

Vishay Semiconductor GmbH, P.O.B. 3535, D-74025 Heilbronn, Germany
Telephone: 49 (0)7131 67 2831, Fax number: 49 (0)7131 67 2423