

Micropower Single Supply Rail-to-Rail Input-Output Precision Op Amp

The EL8188 is a micropower precision op amp optimized for single supply operation at 5V and can operate down to 2.4V.

The EL8188 draws minimal supply current while meeting excellent DC-accuracy, noise, and output drive specifications. Competing devices seriously degrade these parameters to achieve rail-to-rail operation and microamp supply current. Offset current, voltage and current noise, slew rate, and gain-bandwidth product are all 2X to 10X better than on previous micropower rail-to-rail op amps.

The EL8188 can be operated from one lithium cell or two Ni-Cd batteries. The input range includes both the positive and negative rails. The output swings to both rails.

Ordering Information

PART NUMBER	PART MARKING	TAPE & REEL	PACKAGE (Pb-Free)	PKG. DWG. #
Coming Soon EL8188FWZ-T7 (Note)	8178FW	7" (3k pcs)	6 Ld SOT-23	MDP0038
Coming Soon EL8188FWZ-T7A (Note)	8178FW	7" (250 pcs)	6 Ld SOT-23	MDP0038
EL8188FSZ (Note)	8178FSZ	97/Tube	8 Ld SO	MDP0027
EL8188FSZ-T7 (Note)	8178FSZ	7" (1k pcs)	8 Ld SO	MDP0027

NOTE: Intersil Pb-free plus anneal products employ special Pb-free material sets; molding compounds/die attach materials and 100% matte tin plate termination finish, which are RoHS compliant and compatible with both SnPb and Pb-free soldering operations. Intersil Pb-free products are MSL classified at Pb-free peak reflow temperatures that meet or exceed the Pb-free requirements of IPC/JEDEC J STD-020.

Features

- 50µA supply current
- 1mV typ offset voltage
- 2pA input bias current
- 266kHz gain-bandwidth product
- 0.13V/µs slew rate
- Single supply operation down to 2.4V
- Rail-to-rail input and output
- Output sources and sinks 26mA load current
- Pb-free plus anneal available (RoHS compliant)

Applications

- Battery- or solar-powered systems
- 4mA to 20mA current loops
- Handheld consumer products
- Medical devices
- Thermocouple amplifiers
- Photodiode pre-amps
- pH probe amplifiers

Pinouts

EL8188
(6 LD SOT-23 - Coming Soon)
TOP VIEW

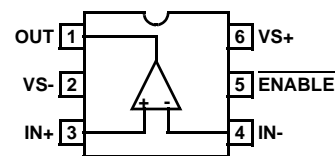

EL8188
(8 LD SO)
TOP VIEW

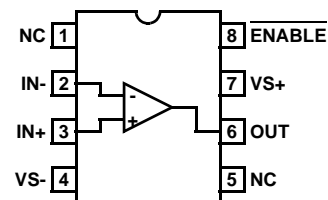

Absolute Maximum Ratings ($T_A = +25^\circ\text{C}$)

Supply Voltage (V_S) and Pwr-up Ramp Rate 5.5V, 1V/ μs
 Differential Input Voltage 0.5V
 Current into IN+, IN-, and ENABLE 5mA
 Input Voltage $V_{S-} - 0.5\text{V}$ to $V_{S+} + 0.5\text{V}$
 ESD tolerance, Human Body Model TBDkV
 ESD tolerance, Machine Model TBDV

Thermal Information

Thermal Resistance θ_{JA} ($^\circ\text{C}/\text{W}$)
 6 Ld SOT Package 230
 8 Ld SO Package 110
 Ambient Operating Temperature Range -40°C to $+125^\circ\text{C}$
 Storage Temperature Range -65°C to $+150^\circ\text{C}$
 Operating Junction Temperature $+125^\circ\text{C}$
 Pb-free reflow profile see link below
<http://www.intersil.com/pbfree/Pb-FreeReflow.asp>

CAUTION: Stresses above those listed in "Absolute Maximum Ratings" may cause permanent damage to the device. This is a stress only rating and operation of the device at these or any other conditions above those indicated in the operational sections of this specification is not implied.

IMPORTANT NOTE: All parameters having Min/Max specifications are guaranteed. Typical values are for information purposes only. Unless otherwise noted, all tests are at the specified temperature and are pulsed tests, therefore: $T_J = T_C = T_A$

Electrical Specifications $V_{S+} = 5\text{V}$, $V_{S-} = 0\text{V}$, $V_{CM} = 0.1\text{V}$, $V_O = 1.4\text{V}$, $T_A = +25^\circ\text{C}$ unless otherwise specified. **Boldface limits** apply over the operating temperature range, **-40°C to $+125^\circ\text{C}$**

PARAMETER	DESCRIPTION	TEST CONDITIONS	MIN	TYP	MAX	UNIT
V_{OS}	Input Offset Voltage	SOT		1	4	mV
$\frac{\Delta V_{OS}}{\Delta \text{Time}}$	Long Term Input Offset Voltage Stability			1.2		$\mu\text{V}/\text{Mo}$
$\frac{\Delta V_{OS}}{\Delta T}$	Input Offset Drift vs Temperature			1.1	2.1	$\mu\text{V}/^\circ\text{C}$
I_B	Input Bias Current		-15	2	15	pA
			-600		600	pA
e_N	Input Noise Voltage Peak-to-Peak	$f = 0.1\text{Hz}$ to 10Hz		2.8		μV_{P-P}
	Input Noise Voltage Density	$f_O = 1\text{kHz}$		48		$\text{nV}/\sqrt{\text{Hz}}$
i_N	Input Noise Current Density	$f_O = 1\text{kHz}$		0.15		$\text{pA}/\sqrt{\text{Hz}}$
CMIR	Input Voltage Range	Guaranteed by CMRR test	0		5	V
CMRR	Common-Mode Rejection Ratio	$V_{CM} = 0\text{V}$ to 5V	80	100		dB
			75			dB
PSRR	Power Supply Rejection Ratio	$V_S = 2.4\text{V}$ to 5V	80	100		dB
			80			dB
A_{VOL}	Large Signal Voltage Gain	$V_O = 0.5\text{V}$ to 4.5V , $R_L = 100\text{k}\Omega$ to $(V_{S+} + V_{S-})/2$	100	400		V/mV
		$V_O = 0.5\text{V}$ to 4.5V , $R_L = 1\text{k}\Omega$ to $(V_{S+} + V_{S-})/2$		15		V/mV
V_{OUT}	Maximum Output Voltage Swing	V_{OL} ; Output low, $R_L = 100\text{k}\Omega$ to $(V_{S+} + V_{S-})/2$		3	8	mV
					10	mV
		V_{OH} ; Output high, $R_L = 1\text{k}\Omega$ to $(V_{S+} + V_{S-})/2$		130	200	mV
					300	mV
SR	Slew Rate		4.994	4.997		V
			4.992			V
GBWP	Gain Bandwidth Product	$f_O = 100\text{kHz}$	4.750	4.867		V
			4.7			V
			0.05	0.13	0.25	V/ μs
				266		kHz

EL8188

Electrical Specifications $V_{S+} = 5V$, $V_{S-} = 0V$, $V_{CM} = 0.1V$, $V_O = 1.4V$, $T_A = +25^\circ C$ unless otherwise specified. **Boldface limits** apply over the operating temperature range, **-40°C to +125°C (Continued)**

PARAMETER	DESCRIPTION	TEST CONDITIONS	MIN	TYP	MAX	UNIT
$I_{S, ON}$	Supply Current, Enabled		35	50	75	μA
			30		90	μA
$I_{S, OFF}$	Supply Current, Disabled			3	10	μA
					10	μA
I_{SC+}	Short Circuit Output Current	$R_L = 10\Omega$ to opposite supply	23	31		mA
			18			mA
I_{SC-}	Short Circuit Output Current	$R_L = 10\Omega$ to opposite supply	20	26		mA
			15			mA
V_S	Minimum Supply Voltage			2.2	2.4	V
					2.4	V
V_{INH}	Enable Pin High Level		2			V
V_{INL}	Enable Pin Low Level				0.8	V
I_{ENH}	Enable Pin Input Current	$V_{EN} = 5V$	0.25	0.7	2	μA
			0.25		2.5	μA
I_{ENL}	Enable Pin Input Current	$V_{EN} = 0V$	-0.5	0	+0.5	μA
			-0.5		+0.5	μA

Typical Performance Curves $V_S = \pm 2.5V$, $T_A = +25^\circ C$, Unless Otherwise Specified

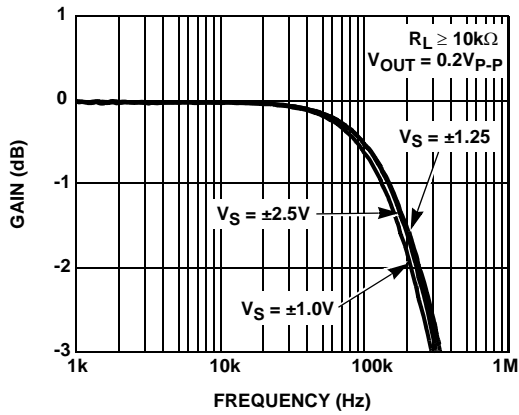

FIGURE 1. UNITY GAIN FREQUENCY RESPONSE at VARIOUS SUPPLY VOLTAGES

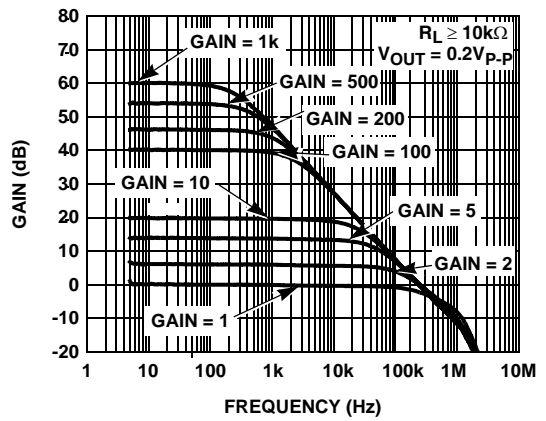

FIGURE 2. FREQUENCY RESPONSE at VARIOUS CLOSED LOOP GAINS

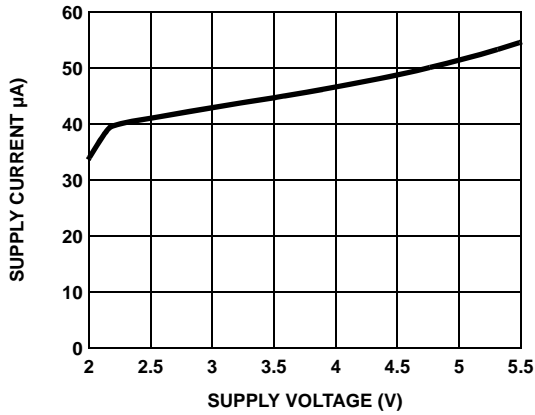

FIGURE 3. SUPPLY CURRENT vs SUPPLY VOLTAGE

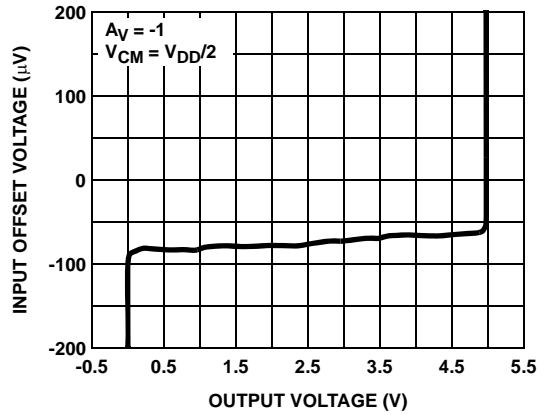

FIGURE 4. INPUT OFFSET VOLTAGE vs OUTPUT VOLTAGE

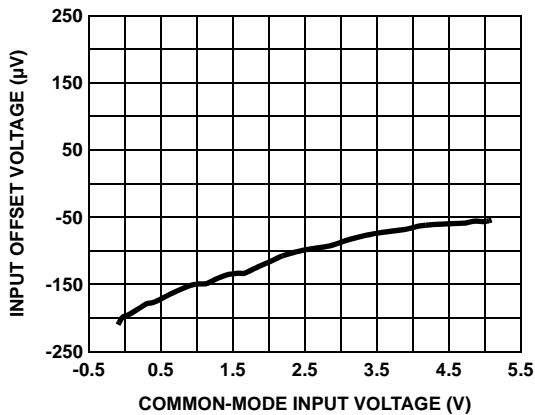

FIGURE 5. INPUT OFFSET VOLTAGE vs COMMON-MODE INPUT VOLTAGE

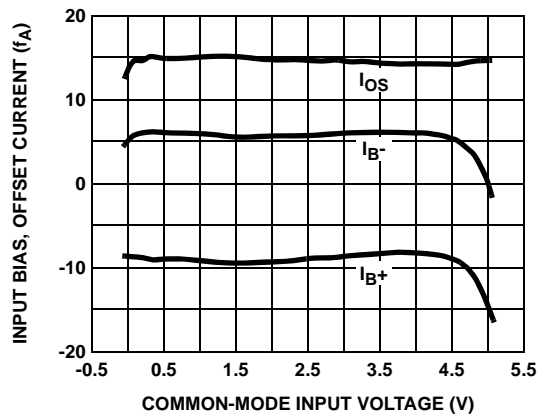

FIGURE 6. INPUT BIAS, OFFSET CURRENT vs COMMON-MODE INPUT VOLTAGE

Typical Performance Curves (Continued) $V_S = \pm 2.5V$, $T_A = +25^\circ C$, Unless Otherwise Specified (Continued)

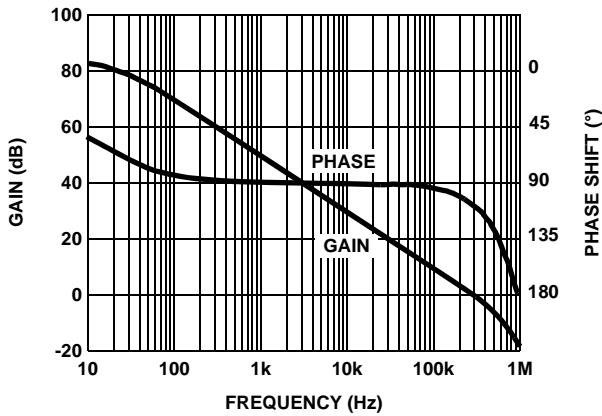

FIGURE 7. OPEN LOOP GAIN AND PHASE vs FREQUENCY ($R_L = 1k\Omega$)

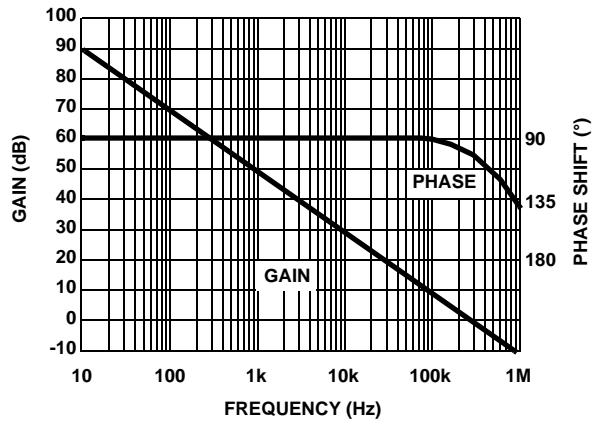

FIGURE 8. OPEN LOOP GAIN AND PHASE vs FREQUENCY ($R_L = 100k\Omega$)

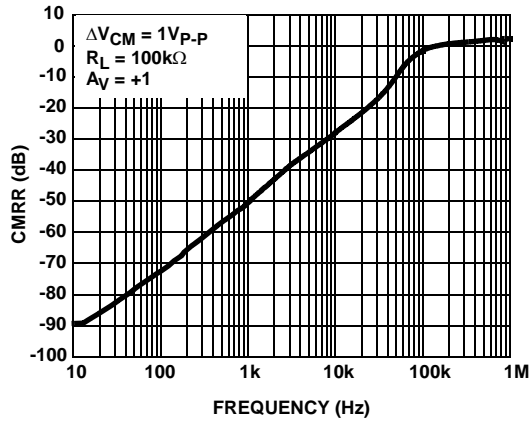

FIGURE 9. CMRR vs FREQUENCY

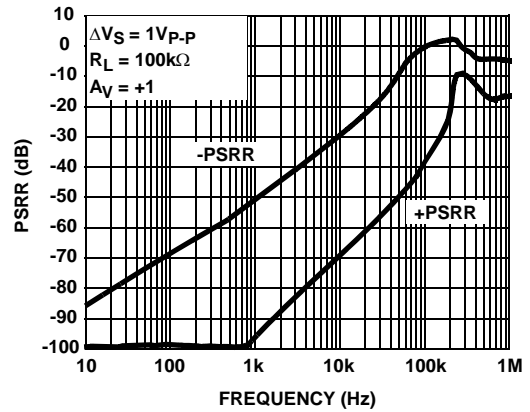

FIGURE 10. PSRR vs FREQUENCY

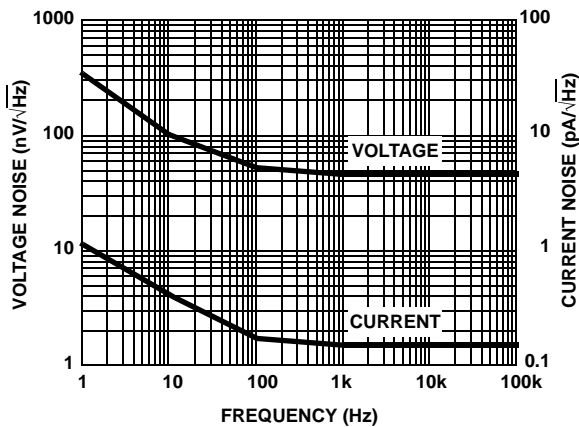

FIGURE 11. INPUT VOLTAGE AND CURRENT NOISE vs FREQUENCY

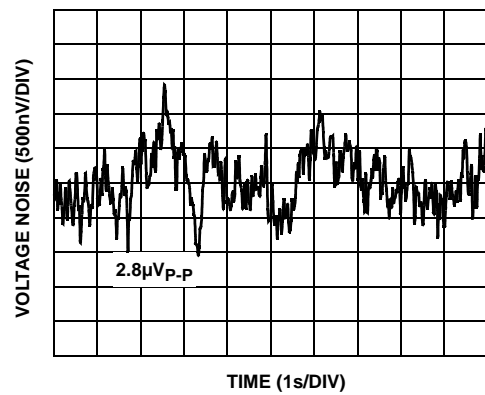

FIGURE 12. 0.1Hz TO 10Hz INPUT VOLTAGE NOISE

Typical Performance Curves (Continued) $V_S = \pm 2.5V$, $T_A = +25^\circ C$, Unless Otherwise Specified (Continued)

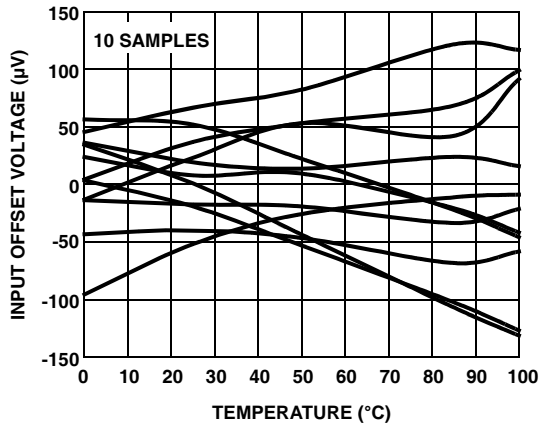

FIGURE 13. V_{OS} vs TEMPERATURE

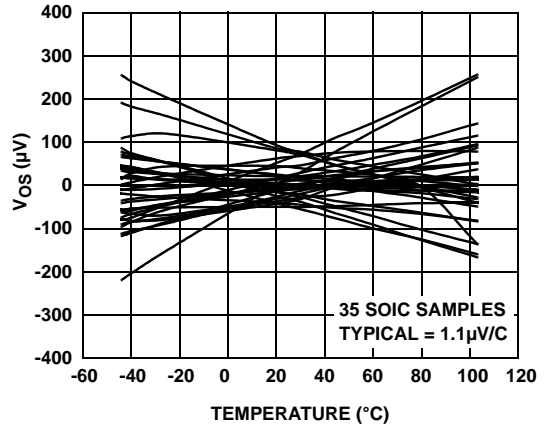

FIGURE 14. EL8188 SOIC V_{OS} vs TEMPERATURE ($V_S = 5V$)

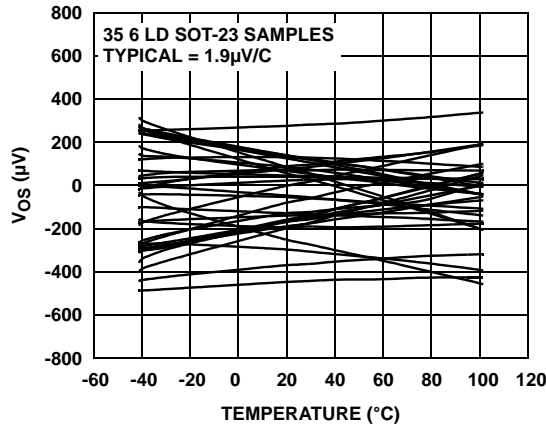

FIGURE 15. EL8188 SOT V_{OS} vs TEMPERATURE ($V_S = 5V$)

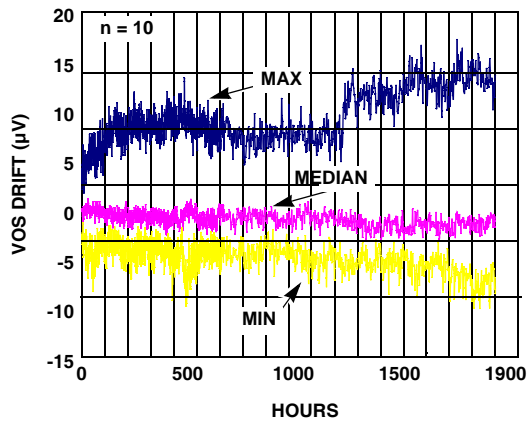

FIGURE 16. V_{OS} DRIFT SOT-23 vs TIME

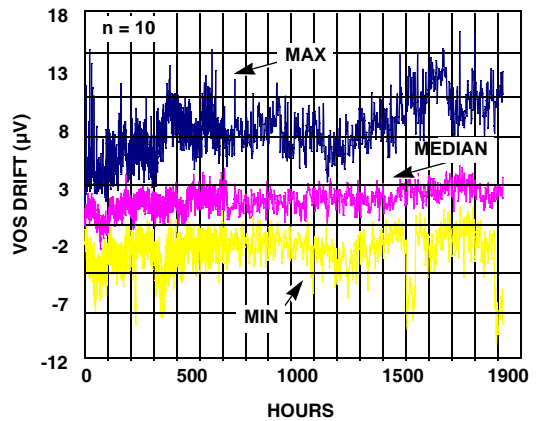
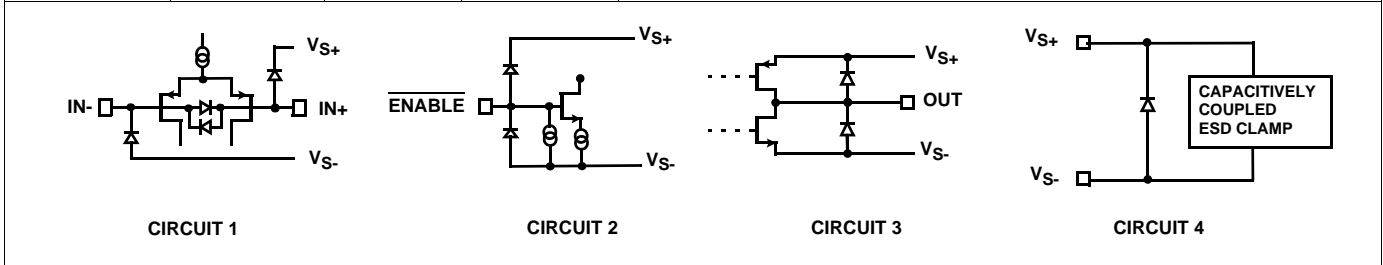

FIGURE 17. V_{OS} DRIFT SOIC vs TIME

Pin Descriptions

SO PIN NUMBER	SOT-23 PIN NUMBER	PIN NAME	EQUIVALENT CIRCUIT	DESCRIPTION
1		NC		No internal connection
2	4	IN-	Circuit 1	Amplifier's inverting input
3	3	IN+	Circuit 1	Amplifier's non-inverting input
4	2	VS-	Circuit 4	Negative power supply
5		NC		No internal connection
6	1	OUT	Circuit 3	Amplifier's output
7	6	VS+	Circuit 4	Positive power supply
8	5	$\overline{\text{ENABLE}}$	Circuit 2	Amplifier's enable pin with internal pull-down; Logic "1" selects the disabled state; Logic "0" selects the enabled state.



Application Information

Introduction

The EL8188 is a rail-to-rail input and output (RRIO), micro-power, precision, single supply op amp with an enable feature. This amplifier is designed to operate from single supply (2.4V to 5.0V) or dual supply ($\pm 1.2V$ to $\pm 2.5V$) while drawing only 50 μA of supply current. The device achieves rail-to-rail input and output operation while eliminating the drawbacks of many conventional RRIO op amps.

Rail-to-Rail Input

The PFET input stage of the EL8188 has an input common-mode voltage range that includes the negative and positive supplies without introducing offset errors or degrading performance like some existing rail-to-rail input op amps. Many rail-to-rail input stages use two differential input pairs: a long-tail PNP (or PFET) and an NPN (or NFET). Severe penalties result from using this topology. As the input signal moves from one supply rail to the other, the op amp switches from one input pair to the other causing drastic changes in input offset voltage and an undesired change in the input offset current's magnitude and polarity.

The EL8188 achieves rail-to-rail input performance without sacrificing important precision specifications and without degrading distortion performance. The EL8188's input offset voltage exhibits a smooth behavior throughout the entire common-mode input range.

Rail-to-Rail Output

A pair of complementary MOSFET devices achieves rail-to-rail output swing. The NMOS sinks current to swing the output in the negative direction, while the PMOS sources current to swing the output in the positive direction. The EL8188 with a 100k Ω load swings to within 3mV of the supply rails.

Enable/Disable Feature

The EL8188 features an active low $\overline{\text{ENABLE}}$ pin that when pulled up to at least 2V disables the output, and drops the already low I_{CC} to a 3 μA trickle. The $\overline{\text{ENABLE}}$ pin has an internal pull down, so an undriven pin pulls to the negative rail, thereby enabling the op amp by default.

The high impedance output during disable allows for connecting multiple EL8188s together to implement a Mux Amp. The outputs are connected together and activating the appropriate $\overline{\text{ENABLE}}$ pin selects the desired channel. If utilizing non-unity gain op amp configurations, then the loading effects of the disabled amplifiers' feedback networks must be considered when evaluating the active amplifier's performance in Mux Amp configurations.

Note that feedthrough from the IN+ to IN- pins occurs on any Mux Amp disabled channel where the input differential voltage exceeds 0.5V (e.g., active channel $V_{OUT} = 1V$, while disabled channel $V_{IN} = GND$), so the mux implementation is best suited for small signal applications. If large signals are required, use series IN+ resistors, or large value R_{FS} , to keep the feedthrough current low enough to minimize the impact on the active channel. See the "Usage Implications" on page 8 for more details.

IN+ and IN- Input Protection

In addition to ESD protection diodes to each supply rail, the EL8188 has additional back-to-back protection diodes across the differential input terminals (see “Circuit 1” on page 7). Obviously, one of these diodes conducts if the magnitude of the differential input voltage ever exceeds the diode’s V_F .

Usage Implications

If the input differential voltage is expected to exceed 0.5V, an external current limiting resistor must be used to ensure the input current never exceeds 5mA. For noninverting unity gain applications the current limiting can be via a series IN+ resistor, or via a feedback resistor of appropriate value. For other gain configurations, the series IN+ resistor is the best choice, unless the feedback (R_F) and gain setting (R_G) resistors are both sufficiently large to limit the input current to 5mA.

Large differential input voltages can arise from several sources:

- 1) During open loop (comparator) operation. Used this way, the IN+ and IN- voltages don’t track, so differentials arise.
- 2) When the amplifier is disabled but an input signal is still present. An R_L or R_G to GND keeps the IN- at GND, while the varying IN+ signal creates a differential voltage. Mux Amp applications are similar, except that the active channel V_{OUT} determines the voltage on the IN- terminal.
- 3) When the slew rate of the input pulse is considerably faster than the op amp’s slew rate. If the V_{OUT} can’t keep up with the IN+ signal, a differential voltage results, and visible distortion occurs on the input and output signals. To avoid this issue, keep the input slew rate below 0.2V/ μ s, or use appropriate current limiting resistors.

Large (>2V) differential input voltages can also cause an increase in disabled I_{CC} .

ENABLE Input Protection

The ENABLE input has internal ESD protection diodes to both the positive and negative supply rails, limiting the input voltage range to within one diode beyond the supply rails (see “Circuit 2” on page 7). If the input voltage is expected to exceed V_{S+} or V_{S-} , then an external series resistor should be added to limit the current to 5mA.

Output Current Limiting

The EL8188 has no internal current-limiting circuitry. If the output is shorted, it is possible to exceed the “Absolute Maximum Rating” for “operating junction temperature”, potentially resulting in the destruction of the device.

Power Dissipation

It is possible to exceed the +150°C maximum junction temperature (T_{JMAX}) under certain load and power-supply conditions. It is therefore important to calculate T_{JMAX} for all applications to determine if power supply voltages, load conditions, or package type need to be modified to remain in

the safe operating area. These parameters are related as follows:

$$T_{JMAX} = T_{MAX} + (\theta_{JA} \times PD_{MAX}) \quad (\text{EQ. 1})$$

where PD_{MAX} is calculated using:

$$PD_{MAX} = V_S \times I_{SMAX} + (V_S - V_{OUTMAX}) \times \frac{V_{OUTMAX}}{R_L} \quad (\text{EQ. 2})$$

where:

- T_{MAX} = Maximum ambient temperature
- θ_{JA} = Thermal resistance of the package
- PD_{MAX} = Maximum power dissipation of the amplifier
- V_S = Supply voltage
- I_{MAX} = Maximum supply current of the amplifier
- V_{OUTMAX} = Maximum output voltage swing of the application
- R_L = Load resistance

Proper Layout Maximizes Precision

To achieve the optimum levels of high input impedance (i.e., low input currents) and low offset voltage, care should be taken in the circuit board layout. The PC board surface must remain clean and free of moisture to avoid leakage currents between adjacent traces. Surface coating of the circuit board will reduce surface moisture and provide a humidity barrier, reducing parasitic resistance on the board. When input leakage current is a paramount concern, the use of guard rings around the amplifier inputs will further reduce leakage currents. Figure 18 shows a guard ring example for a unity gain amplifier that uses the low impedance amplifier output at the same voltage as the high impedance input to eliminate surface leakage. The guard ring does not need to be a specific width, but it should form a continuous loop around both inputs. For further reduction of leakage currents, mount components to the PC board using Teflon standoffs.

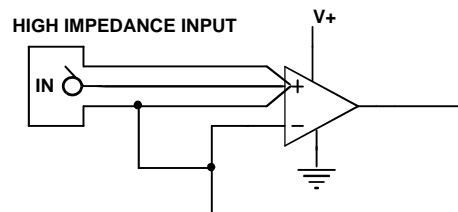

FIGURE 18. GUARD RING EXAMPLE FOR UNITY GAIN AMPLIFIER

Typical Applications

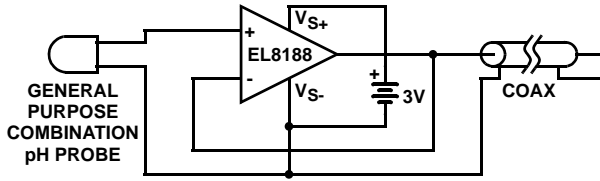

FIGURE 19. pH PROBE AMPLIFIER

A general-purpose combination pH probe has extremely high output impedance typically in the range of 10GΩ to 12GΩ. Low loss and expensive Teflon cables are often used to connect the pH probe to the meter electronics. Figure 19 details a low-cost alternative solution using the EL8188 and a low-cost coax cable. The EL8188 PMOS high impedance input senses the pH probe output signal and buffers it to drive the coax cable. Its rail-to-rail input nature also eliminates the need for a bias resistor network required by other amplifiers in the same application.

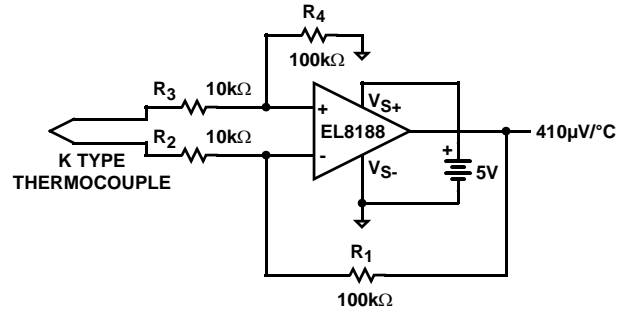
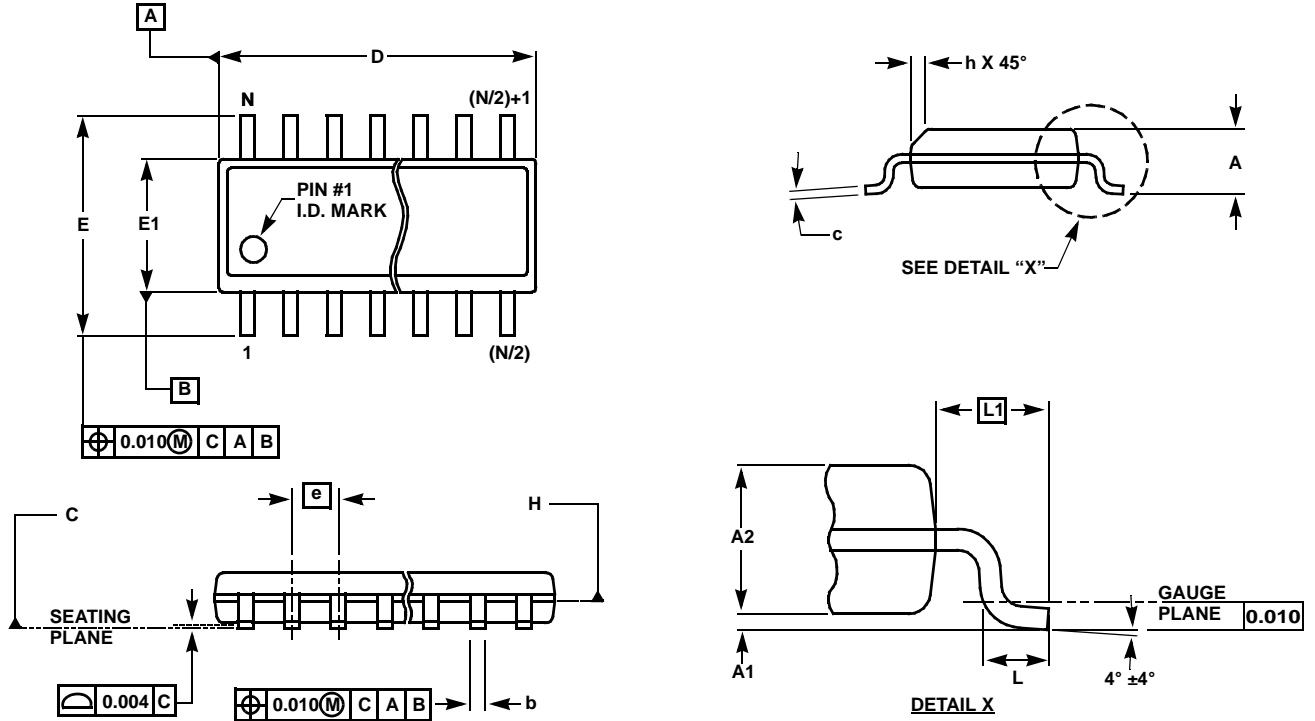

FIGURE 20. THERMOCOUPLE AMPLIFIER

Thermocouples are the most popular temperature sensing devices because of their low cost, interchangeability, and ability to measure a wide range of temperatures. In Figure 20, the EL8188 converts the differential thermocouple voltage into single-ended signal with 10X gain. The EL8188's rail-to-rail input characteristic allows the thermocouple to be biased at ground and permits the op amp to operate from a single 5V supply.

Small Outline Package Family (SO)



MDP0027

SMALL OUTLINE PACKAGE FAMILY (SO)

SYMBOL	INCHES							TOLERANCE	NOTES
	SO-8	SO-14	SO16 (0.150")	SO16 (0.300") (SOL-16)	SO20 (SOL-20)	SO24 (SOL-24)	SO28 (SOL-28)		
A	0.068	0.068	0.068	0.104	0.104	0.104	0.104	MAX	-
A1	0.006	0.006	0.006	0.007	0.007	0.007	0.007	± 0.003	-
A2	0.057	0.057	0.057	0.092	0.092	0.092	0.092	± 0.002	-
b	0.017	0.017	0.017	0.017	0.017	0.017	0.017	± 0.003	-
c	0.009	0.009	0.009	0.011	0.011	0.011	0.011	± 0.001	-
D	0.193	0.341	0.390	0.406	0.504	0.606	0.704	± 0.004	1, 3
E	0.236	0.236	0.236	0.406	0.406	0.406	0.406	± 0.008	-
E1	0.154	0.154	0.154	0.295	0.295	0.295	0.295	± 0.004	2, 3
e	0.050	0.050	0.050	0.050	0.050	0.050	0.050	Basic	-
L	0.025	0.025	0.025	0.030	0.030	0.030	0.030	± 0.009	-
L1	0.041	0.041	0.041	0.056	0.056	0.056	0.056	Basic	-
h	0.013	0.013	0.013	0.020	0.020	0.020	0.020	Reference	-
N	8	14	16	16	20	24	28	Reference	-

Rev. M 2/07

NOTES:

1. Plastic or metal protrusions of 0.006" maximum per side are not included.
2. Plastic interlead protrusions of 0.010" maximum per side are not included.
3. Dimensions "D" and "E1" are measured at Datum Plane "H".
4. Dimensioning and tolerancing per ASME Y14.5M-1994

SOT-23 Package Family

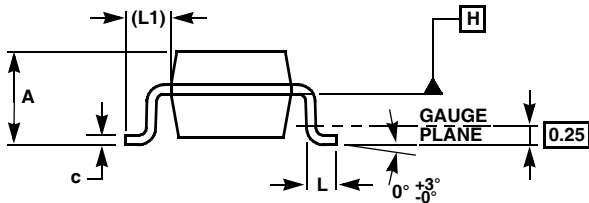
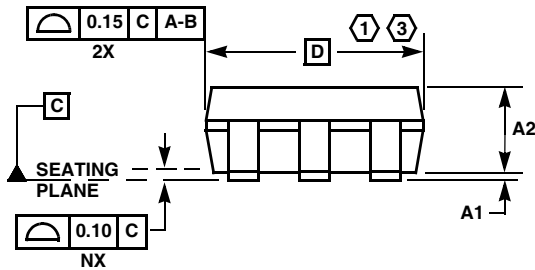
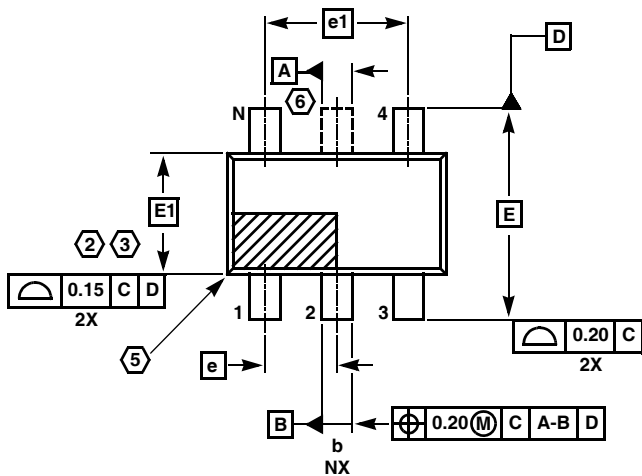

MDP0038
SOT-23 PACKAGE FAMILY

SYMBOL	MILLIMETERS		TOLERANCE
	SOT23-5	SOT23-6	
A	1.45	1.45	MAX
A1	0.10	0.10	±0.05
A2	1.14	1.14	±0.15
b	0.40	0.40	±0.05
c	0.14	0.14	±0.06
D	2.90	2.90	Basic
E	2.80	2.80	Basic
E1	1.60	1.60	Basic
e	0.95	0.95	Basic
e1	1.90	1.90	Basic
L	0.45	0.45	±0.10
L1	0.60	0.60	Reference
N	5	6	Reference

Rev. F 2/07

NOTES:

1. Plastic or metal protrusions of 0.25mm maximum per side are not included.
2. Plastic interlead protrusions of 0.25mm maximum per side are not included.
3. This dimension is measured at Datum Plane "H".
4. Dimensioning and tolerancing per ASME Y14.5M-1994.
5. Index area - Pin #1 I.D. will be located within the indicated zone (SOT23-6 only).
6. SOT23-5 version has no center lead (shown as a dashed line).

All Intersil U.S. products are manufactured, assembled and tested utilizing ISO9000 quality systems.
Intersil Corporation's quality certifications can be viewed at www.intersil.com/design/quality

Intersil products are sold by description only. Intersil Corporation reserves the right to make changes in circuit design, software and/or specifications at any time without notice. Accordingly, the reader is cautioned to verify that data sheets are current before placing orders. Information furnished by Intersil is believed to be accurate and reliable. However, no responsibility is assumed by Intersil or its subsidiaries for its use; nor for any infringements of patents or other rights of third parties which may result from its use. No license is granted by implication or otherwise under any patent or patent rights of Intersil or its subsidiaries.

For information regarding Intersil Corporation and its products, see www.intersil.com