

Typical Applications

- TDMA-GSM Cellular/PCS Handsets
- TDMA Cellular/PCS Handsets
- GAIT Handsets
- CDMA Cellular/PCS Handsets
- GSM DCS/PCS Handsets

Product Description

The RF2492 is a fully featured dual-band LNA/Mixer and is usable in a variety of mobile handset applications. The unique dual IF outputs provide interface to two independent IF SAW filters supporting applications such as TDMA-EDGE where 30kHz and 200kHz bandwidth SAW filters are used. With independent power management control pins for the LNAs and mixers, either IF output can be accessed from either high- or low-band LNAs, providing maximum flexibility with minimum power usage. Multiple gain control options are provided to achieve a very large dynamic range for the receiver. A frequency doubler is included in the LO circuit to generate both high- and low-band LO signals with a single VCO. The RF2492 is packaged in a 32 pin, 5mmx5mm, leadless plastic package.

Optimum Technology Matching® Applied

- |                                     |  |                                      |
|-------------------------------------|--|--------------------------------------|
| <input type="checkbox"/> Si BJT     | <input type="checkbox"/> GaAs HBT            | <input type="checkbox"/> GaAs MESFET |
| <input type="checkbox"/> Si Bi-CMOS | <input checked="" type="checkbox"/> SiGe HBT | <input type="checkbox"/> Si CMOS     |

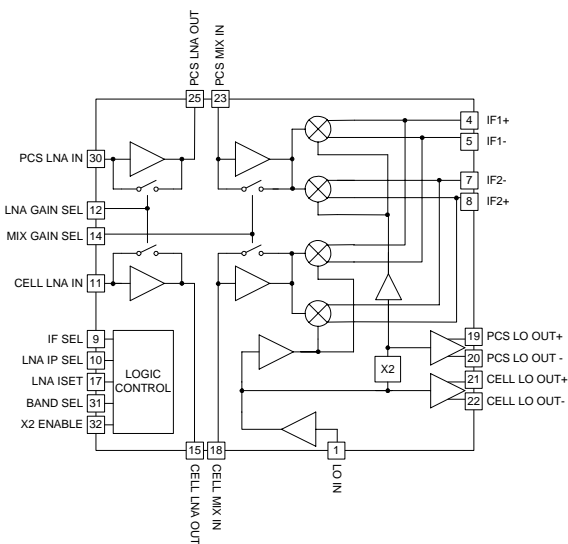

Functional Block Diagram

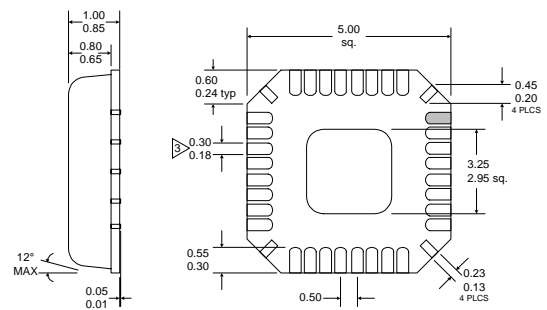

- NOTES:
- 1 Shaded Pin is Lead 1.
  - 2 Pin 1 identifier must exist on top surface of package by identification mark or feature on the package body. Exact shape and size is optional.
  - 3 Dimension applies to plated terminal: to be measured between 0.02 mm and 0.25 mm from terminal end.
  - 4 Package Warpage: 0.05 mm max.
  - 5 Die Thickness Allowable: 0.305 mm max.

Package Style: LCC, 32-Pin, 5x5

Features

- Complete Dual-Band Receiver Front End
- Low Noise Figure
- Stepped LNA/Mixer Gain Control
- Adjustable LNA Bias Current/IIP3
- Integrated LO Frequency Doubler
- Differential LO Buffer Outputs

Ordering Information

- |             |                                     |
|-------------|-------------------------------------|
| RF2492      | Dual-Band Low Noise Amplifier/Mixer |
| RF2492 PCBA | Fully Assembled Evaluation Board    |

RF Micro Devices, Inc.  
7625 Thorndike Road  
Greensboro, NC 27409, USA

Tel (336) 664 1233  
Fax (336) 664 0454  
<http://www.rfmd.com>

### Absolute Maximum Ratings

Parameter	Rating	Unit
Supply Voltage	-0.5 to +5.0	V <sub>DC</sub>
Input LO and RF Levels	+6	dBm
Operating Ambient Temperature	-40 to +85	°C
Storage Temperature	-40 to +150	°C



**Caution!** ESD sensitive device.

RF Micro Devices believes the furnished information is correct and accurate at the time of this printing. However, RF Micro Devices reserves the right to make changes to its products without notice. RF Micro Devices does not assume responsibility for the use of the described product(s).

Parameter	Specification			Unit	Condition
	Min.	Typ.	Max.		
<b>Overall</b>					T = 25°C, V <sub>CC</sub> = 2.75V
RF Frequency Range		881		MHz	Specifications
		1960		MHz	Specifications
	800		950	MHz	Usable range
	1700		2100	MHz	Usable range
IF Frequency Range		110		MHz	Specifications
	50		250	MHz	Usable range
Cell LO Buffer Output	-13.0	-12.7		dBm	T1 insertion loss not considered.
PCS LO Buffer Output	-14.0	-12.7		dBm	T2 insertion loss not considered.
<b>Cellular Band</b>					Freq = 869MHz to 894MHz
<b>LNA (On)</b>					RF = 880MHz and 881 MHz
Gain	13.5	14.5	15.5	dB	LNA set for max IIP3
	13.5	14	15	dB	LNA set for Nominal IIP3
Noise Figure		2.0	2.2	dB	LNA set for max IIP3
		1.8	2.0	dB	LNA set for Nominal IIP3
Input IP3	+7.0	+7.5		dBm	LNA set for max IIP3
	+1.5	+3.0	+7.0	dBm	LNA set for Nominal IIP3
<b>LNA (Off)</b>					
Gain	-8.5	-7.5	-6.5	dB	
Noise Figure	5.5	5.8	6.0	dB	
Input IP3	+20.0	+21.0		dBm	
<b>Mixer</b>					IF Select = 1, (IF1) RF = 880MHz, LO = 990MHz @ -5dBm
Gain	12	13	14	dB	Mixer RF amp ON; Z <sub>LOAD</sub> = 1kΩ single-ended
	3.5	4.4	5.0	dB	Mixer RF amp OFF
Noise Figure	6.5	7.0	7.5	dB	Mixer RF amp ON
	13.5	14.0	14.5	dB	Mixer RF amp OFF
Input IP3	+2.0	+4.5		dBm	Mixer RF amp ON
	+11.5	+13.8		dBm	Mixer RF amp OFF
LO Input Level		-5		dBm	Specifications
	-10		+3	dBm	Usable range
<b>Mixer</b>					IF Select = 0, (IF2) RF = 880MHz, LO = 990MHz @ -5dBm
Gain	12	13	14	dB	Mixer RF amp ON; Z <sub>LOAD</sub> = 1kΩ single-ended
	3.0	4.4		dB	Mixer RF amp OFF
Noise Figure	6.8	7.2	7.4	dB	Mixer RF amp ON
	13.7	14.0	14.2	dB	Mixer RF amp OFF
Input IP3	+2.0	+4.5		dBm	Mixer RF amp ON
	+11.5	+14.0		dBm	Mixer RF amp OFF
LO Input Level		-5		dBm	Specifications
	-10		+3	dBm	Usable range

Parameter	Specification			Unit	Condition
	Min.	Typ.	Max.		
<b>Mixer Isolation</b>					
LO to RF	40	42		dB	Mixer RF amp ON
LO to RF	33.5	35		dB	Mixer RF amp OFF
RF to LO	56.5	63		dB	Mixer RF amp ON
RF to LO	54.5	60.5		dB	Mixer RF amp OFF
LO to IF1	24	36.5		dB	Mixer RF amp ON
LO to IF2	28	42		dB	Mixer RF amp ON
IF1 to RF	50	51		dB	Mixer RF amp ON
RF to IF1	43.5	44.5		dB	Mixer RF amp ON
IF2 to RF	49.5	50.5		dB	Mixer RF amp ON
RF to IF2	43	45		dB	Mixer RF amp ON
<b>Cascade (LNA On)</b>					
Gain		24.5		dB	IF Select=1, 3dB RF Filter Insertion Loss
		24		dB	LNA set for max IIP3; Mixer RF amp ON
		15.9		dB	LNA set for Nominal IIP3; Mixer RF amp ON
		15.4		dB	LNA set for max IIP3; Mixer RF amp OFF
Noise Figure		2.8		dB	LNA set for Nominal IIP3; Mixer RF amp OFF
		2.7		dB	LNA set for max IIP3; Mixer RF amp ON
		5.3		dB	LNA set for Nominal IIP3; Mixer RF amp ON
		5.4		dB	LNA set for max IIP3; Mixer RF amp OFF
Input IP3		-6.5		dBm	LNA set for Nominal IIP3; Mixer RF amp OFF
		-6.4		dBm	LNA set for max IIP3; Mixer RF amp ON
		+1.1		dBm	LNA set for Nominal IIP3; Mixer RF amp ON
		0		dBm	LNA set for max IIP3; Mixer RF amp OFF
				dBm	LNA set for Nominal IIP3; Mixer RF amp OFF
<b>Cascade (LNA Off)</b>					
Gain		2.5		dB	IF Select=1, 3dB RF Filter Insertion Loss
		-6.0		dB	Mixer RF amp ON
Noise Figure		17.4		dB	Mixer RF amp OFF
		24.5		dB	Mixer RF amp ON
Input IP3		+14.5		dBm	Mixer RF amp OFF
		+19.0		dBm	Mixer RF amp ON
				dBm	Mixer RF amp OFF
<b>PCS Band</b>	Freq=1930MHz to 1990MHz				
<b>LNA (On)</b>					
Gain	13.0	14.8		dB	RF=1960MHz and 1961MHz
	13.0	14.0		dB	LNA set for max IIP3
Noise Figure		1.5	1.9	dB	LNA set for Nominal IIP3
	1.7	1.8	1.9	dB	LNA set for max IIP3
Input IP3	+7.0	+9.0		dBm	LNA set for Nominal IIP3
	+0.5	+3.5		dBm	LNA set for max IIP3
				dBm	LNA set for Nominal IIP3
<b>LNA (Off)</b>					
Gain	-7.0	-5.5		dB	
Noise Figure	6.0	6.2	6.5	dB	
Input IP3	+20.0	+25.0		dBm	
<b>Mixer</b>					
Gain	11.5	12.5		dB	RF=1960MHz, LO=1035MHz @ -5dBm, IF Select=1 (IF1)
	2.0	3.5		dB	Mixer RF amp ON; Z <sub>LOAD</sub> =1kΩ single-ended
Noise Figure	8.0	8.5	9.0	dB	Mixer RF amp OFF
	15.0	15.5	16.0	dB	Mixer RF amp ON
Input IP3	+4.0	+6.0		dBm	Mixer RF amp OFF
	+14.0	+16.0		dBm	Mixer RF amp ON
LO Input Level		-5		dBm	Mixer RF amp OFF
	-10		+3	dBm	Specifications Usable range

FRONT-ENDS

Parameter	Specification			Unit	Condition
	Min.	Typ.	Max.		
<b>Mixer</b>					RF=1960MHz, LO=1035MHz @ -5dBm, IF Select=0 (IF2)
Gain	11.0	12.6		dB	Mixer RF amp ON; Z <sub>LOAD</sub> =1 kΩ single-ended
Noise Figure	2.0	3.5		dB	Mixer RF amp OFF
	8.0	8.4	9.0	dB	Mixer RF amp ON
	15.0	15.5	16.5	dB	Mixer RF amp OFF
Input IP3	+3.5	+6.0		dBm	Mixer RF amp ON
LO Input Level	+14.0	+16.0		dBm	Mixer RF amp OFF
	-10	-5	+3	dBm	Specifications Usable range
<b>Mixer Isolation</b>					
LO to RF	55	57.5		dB	Mixer RF amp ON
LO to RF	54	63		dB	Mixer RF amp OFF
RF to LO	49.8	52.5		dB	Mixer RF amp ON
RF to LO	52	55.5		dB	Mixer RF amp OFF
LO to IF1	54.5	55.5		dB	Mixer RF amp ON
LO to IF2	58.5	59		dB	Mixer RF amp ON
IF1 to RF	49.5	51		dB	Mixer RF amp ON
RF to IF1	33	34.5		dB	Mixer RF amp ON
IF2 to RF	49	50.5		dB	Mixer RF amp ON
RF to IF2	41	42.5		dB	Mixer RF amp ON
<b>Cascade (LNA On)</b>					3dB RF Filter Insertion Loss
Gain		24.3		dB	LNA set for max IIP3; Mixer RF amp ON
		23.5		dB	LNA set for Nominal IIP3; Mixer RF amp ON
		15.3		dB	LNA set for max IIP3; Mixer RF amp OFF
Noise Figure		14.5		dB	LNA set for Nominal IIP3; Mixer RF amp OFF
		2.6		dB	LNA set for max IIP3; Mixer RF amp ON
		3.1		dB	LNA set for Nominal IIP3; Mixer RF amp ON
Input IP3		5.7		dB	LNA set for max IIP3; Mixer RF amp OFF
		6.3		dB	LNA set for Nominal IIP3; Mixer RF amp OFF
		-6		dBm	LNA set for max IIP3; Mixer RF amp ON
		-5.6		dBm	LNA set for Nominal IIP3; Mixer RF amp ON
		+3.0		dBm	LNA set for max IIP3; Mixer RF amp OFF
	+1.5		dBm	LNA set for Nominal IIP3; Mixer RF amp OFF	
<b>Cascade (LNA Off)</b>					3dB RF Filter Insertion Loss
Gain		4		dB	Mixer RF amp ON
Noise Figure		-5		dB	Mixer RF amp OFF
		17		dB	Mixer RF amp ON
		24		dB	Mixer RF amp OFF
Input IP3		+14.0		dBm	Mixer RF amp ON
		+21.7		dBm	Mixer RF amp OFF
<b>Power Supply</b>					IF Select=1
Supply Voltage	2.7	2.75		V	Specifications
			3.6	V	Operating range
Supply Current		38	40	mA	Cellular; LNA On, Max IIP3, Mixer RF amp ON
		36	38	mA	Cellular; LNA On, Nom IIP3, Mixer RF amp ON
		32	34	mA	Cellular; LNA Off, Mixer RF amp ON
		26	28	mA	Cellular; LNA Off, Mixer RF amp OFF
		40.0	42.5	mA	PCS; LNA On, Max IIP3, Mixer RF amp ON
LNA Current		38.5	40.5	mA	PCS; LNA On, Nom IIP3, Mixer RF amp ON
		34.5	36.0	mA	PCS; LNA Off, Mixer RF amp ON
		28.0	29.5	mA	PCS; LNA Off, Mixer RF amp OFF

State Table (Typical Values for  $V_{CC}=2.75V$  and 3dB RF Filter Insertion Loss)

Parameter	Cellular						PCS					
	LNA On				LNA Off		LNA On				LNA Off	
	LNA at Max IIP3		LNA at Nom IIP3		Mixer Amp On	Mixer Amp Off	LNA at Max IIP3		LNA at Nom IIP3		Mixer Amp On	Mixer Amp Off
	Mixer Amp On	Mixer Amp Off	Mixer Amp On	Mixer Amp Off			Mixer Amp On	Mixer Amp Off	Mixer Amp On	Mixer Amp Off		
<b>Cascade</b>												
Gain (dB)	24.5	15.9	24	15.4	2	-6.8	24.3	15.3	23.5	14.5	4	-5
Noise Figure (dB)	2.8	5.3	2.7	5.4	18.2	25.2	2.6	5.7	3.1	6.3	17	24
Input IP3 (dBm)	-6.5	+1.1	-6.4	0	+14.9	+19.5	-6	+3	-5.6	+1.5	+14	+21.7
Total Current	38		36		32	26	40		38.5		34.5	28
<b>LNA</b>												
Gain (dB)	14.5	14.5	14	14	-7.5	-7.5	14.8	14.8	14	14	-5.5	-5.5
Noise Figure (dB)	2.0	2.0	1.8	1.8	5.8	5.8	1.5	1.5	1.8	1.8	6.2	6.2
Input IP3 (dBm)	+7.5	+7.5	+3	+3	+21	+21	+9	+9	+3.5	+3.5	25	25
Isolation (dB)												
LNA Current (mA)												
<b>Mixer</b>												
Gain (dB)	13	4.4	13	4.4	13	4.4	12.5	3.5	12.5	3.5	12.5	3.5
Noise Figure (dB)	7	14	7	14	7	14	8.5	15.5	8.5	15.5	8.5	15.5
Input IP3 (dBm)	+5.1	+13.8	+5.1	+13.8	+5.1	+13.8	+6	+16	+6	+16	+6	+16
LO Input Level (dBm)	-5	-5	-5	-5	-5	-5	-5	-5	-5	-5	-5	-5
LO to RF Isolation(dB)												
Mixer Current (mA)												

Control Logic Table

	BAND SEL	IF SEL	LNA GAIN	MIX GAIN	LNA IP SEL	ENABLE
PCS IF2 High Gain/High Linearity	1	0	1	1	1	1
PCS IF2 High Gain/Nominal Linearity	1	0	1	1	0	1
PCS IF2 Mid1 Gain	1	0	1	0	0	1
PCS IF2 Mid2 Gain	1	0	0	1	0	1
PCS IF2 Low Gain	1	0	0	0	0	1
Cell IF2 High Gain/High Linearity	0	0	1	1	1	1
Cell IF2 High Gain/Nominal Linearity	0	0	1	1	0	1
Cell IF2 Mid1 Gain	0	0	1	0	0	1
Cell IF2 Mid2 Gain	0	0	0	1	0	1
Cell IF2 Low Gain	0	0	0	0	0	1
Cell IF1 High Gain/High Linearity	0	1	1	1	1	1
Cell IF1 High Gain/Nominal Linearity	0	1	1	1	0	1
Cell IF1 Mid1 Gain	0	1	1	0	0	1
Cell IF1 Mid2 Gain	0	1	0	1	0	1
Cell IF1 Low Gain	0	1	0	0	0	1
Shutdown	X	X	X	X	X	0
Not Defined	1	1	X	X	X	1

Pin	Function	Description	Interface Schematic
1	LO IN	LO input for both bands. Impedance is approximately $(120-j25)\Omega$ .	1 k $\Omega$ shunt resistor (static bleed). AC coupled to transistor base (internal DC block).
2	VCC2	Power supply connection for internal LO amplifiers. External low-inductance bypass capacitor between 1 nF and 47 nF recommended.	
3	GND	Ground connection.	
4	IF1+	High-band IF output. Open collector. "Current combiner" IF interface to 1000 $\Omega$ SAW filter recommended	2 pF internal shunt capacitance.
5	IF1-	High-band IF output. Open collector. "Current combiner" IF interface to 1000 $\Omega$ SAW filter recommended	2 pF internal shunt capacitance.
6	BYPASS	Pin requires external bypass capacitor between 1 nF and 47 nF.	
7	IF2-	Low-band IF output. Open collector. "Current combiner" IF interface to 1000 $\Omega$ SAW filter recommended	2 pF internal shunt capacitance.
8	IF2+	Low-band IF output. Open collector. "Current combiner" IF interface to 1000 $\Omega$ SAW filter recommended	2 pF internal shunt capacitance.
9	IF SEL	Logic input. High selects IF1 mixer; low selects IF2 mixer.	Diode to $V_{CC}$ and Ground. CMOS logic interface.
10	LNA IP SEL	Logic input. High selects external LNA current reference (pin 17); low selects internal LNA current reference.	Diode to $V_{CC}$ and Ground. CMOS logic interface.
11	CELL LNA IN	Low-band LNA input (base). Simple external matching required for best performance.	
12	LNA GAIN SEL	Logic input. High selects maximum LNA gain; low selects minimum LNA gain.	Diode to $V_{CC}$ and Ground. CMOS logic interface.
13	VCC1	Power supply for internal references, logic, and mixer preamplifiers. Internal RF bypass capacitor. External bypass capacitor between 1 nF and 47 nF required.	
14	MIX GAIN SEL	Logic input. High selects maximum mixer gain (mixer RF amp on); low selects minimum mixer gain (mixer RF amp off).	Diode to $V_{CC}$ and Ground. CMOS logic interface.
15	CELL LNA OUT	Low-band LNA output (collector). Simple external L-C matching required.	
16	GND	Ground connection. See evaluation board layout.	
17	LNA ISET	External current reference for LNA. Resistor to ground sets LNA current when Pin 10 is high. 20 k $\Omega$ results in approximately 10 mA LNA current. Higher resistance results in lower current.	
18	CELL MIX IN	Low band mixer RF preamplifier input (base). External L-C network required for best performance.	
19	PCS LO OUT+	High-band buffered LO output.	Internal DC blocking capacitor. 1 k $\Omega$ shunt resistor (static bleed).
20	PCS LO OUT-	High-band buffered LO output.	Internal DC blocking capacitor. 1 k $\Omega$ shunt resistor (static bleed).
21	CELL LO OUT+	Low-band buffered LO output.	Internal DC blocking capacitor. 1 k $\Omega$ shunt resistor (static bleed).
22	CELL LO OUT-	Low-band buffered LO output.	Internal DC blocking capacitor. 1 k $\Omega$ shunt resistor (static bleed).
23	PCS MIX IN	High-band mixer RF preamplifier input (base). External L-C network required for best performance.	
24	GND	Ground connection. Keep traces physically short and connect immediately to ground plane (low-inductance ground required for best performance).	

Pin	Function	Description	Interface Schematic
25	PCS LNA OUT	High-band LNA output (collector). Small external inductance required for best impedance match to 50Ω.	
26	VCC2	High-band LNA power supply connection. Small series inductance required.	
27	GND2	High-band LNA emitter. Low-inductance ground required.	
28	GND2	Same as pin 27.	
29	GND2	Same as pin 27.	
30	PCS LNA IN	High-band LNA input (base). Simple external matching required for best performance.	
31	BAND SEL	Logic input. High selects high-band operation; low selects low-band operation.	Diode to $V_{CC}$ and Ground. CMOS logic interface.
32	X2 ENABLE	Logic input. High enables LO doubler; low disables LO doubler.	Diode to $V_{CC}$ and Ground. CMOS logic interface.
Die Flag	GND	Low inductance ground connection critical to proper operation.	

## Pin Out

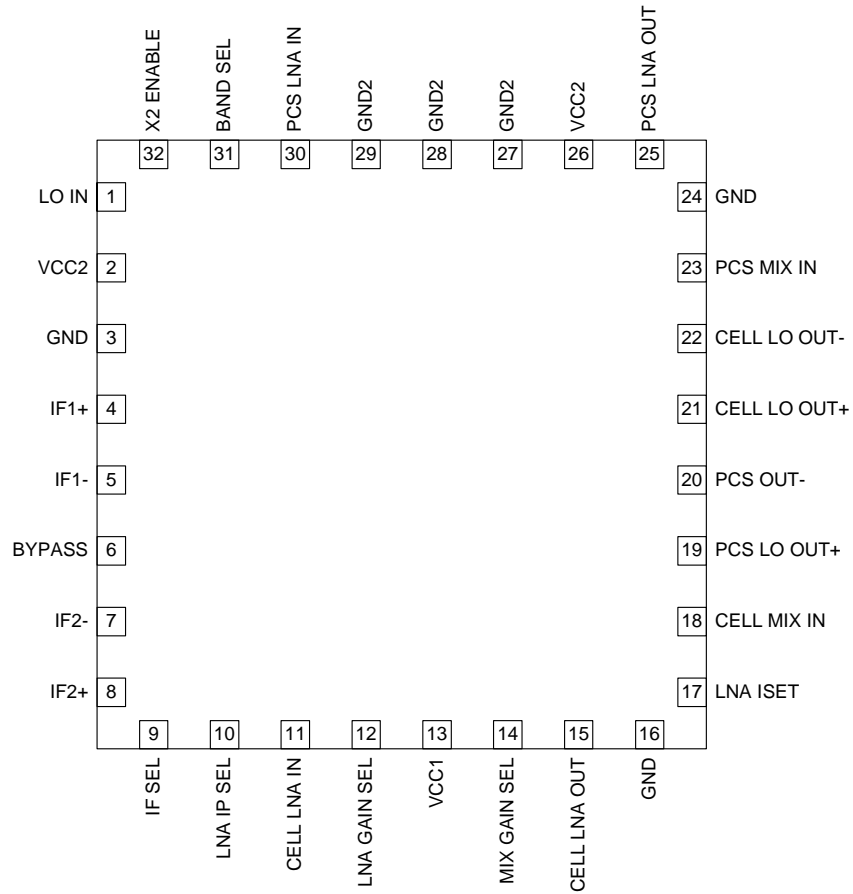



# Application Schematic

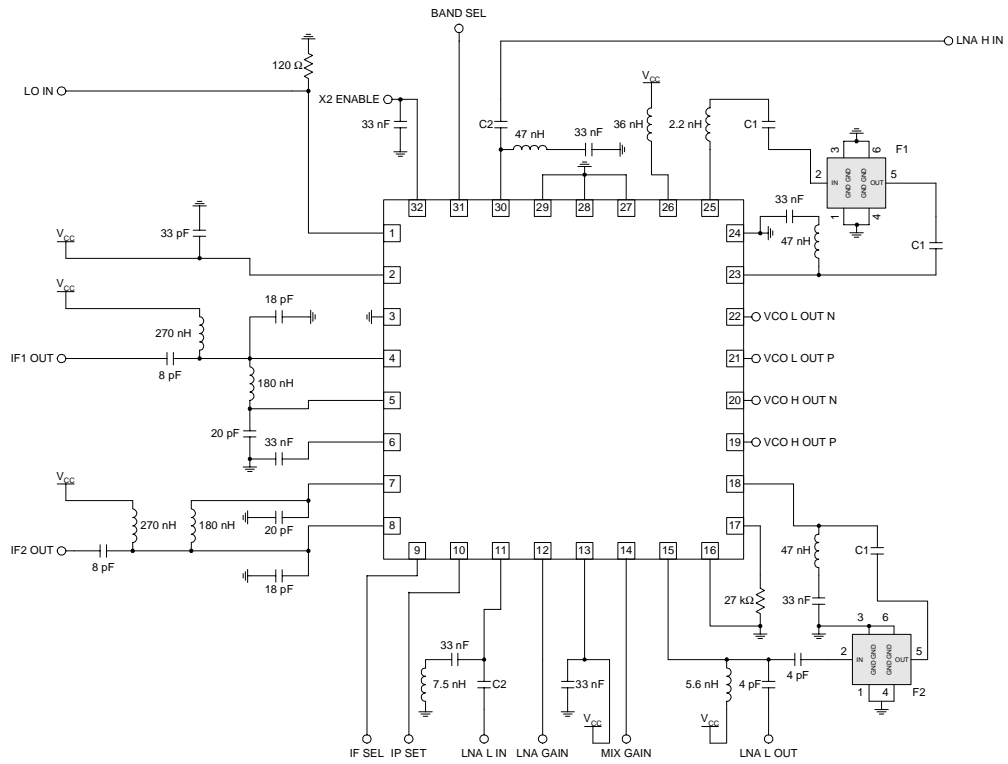

- NOTES:**
1. C1's are not needed if filter DC impedance is open circuit (as is normally the case).
  2. C2's are not needed if duplexer DC impedance is open circuit (as is normally the case).
  3. IF interface shown is 50 Ω @ 110 MHz.

## Evaluation Board Schematic IF = 110MHz

(Download [Bill of Materials](http://www.rfmd.com) from [www.rfmd.com](http://www.rfmd.com).)

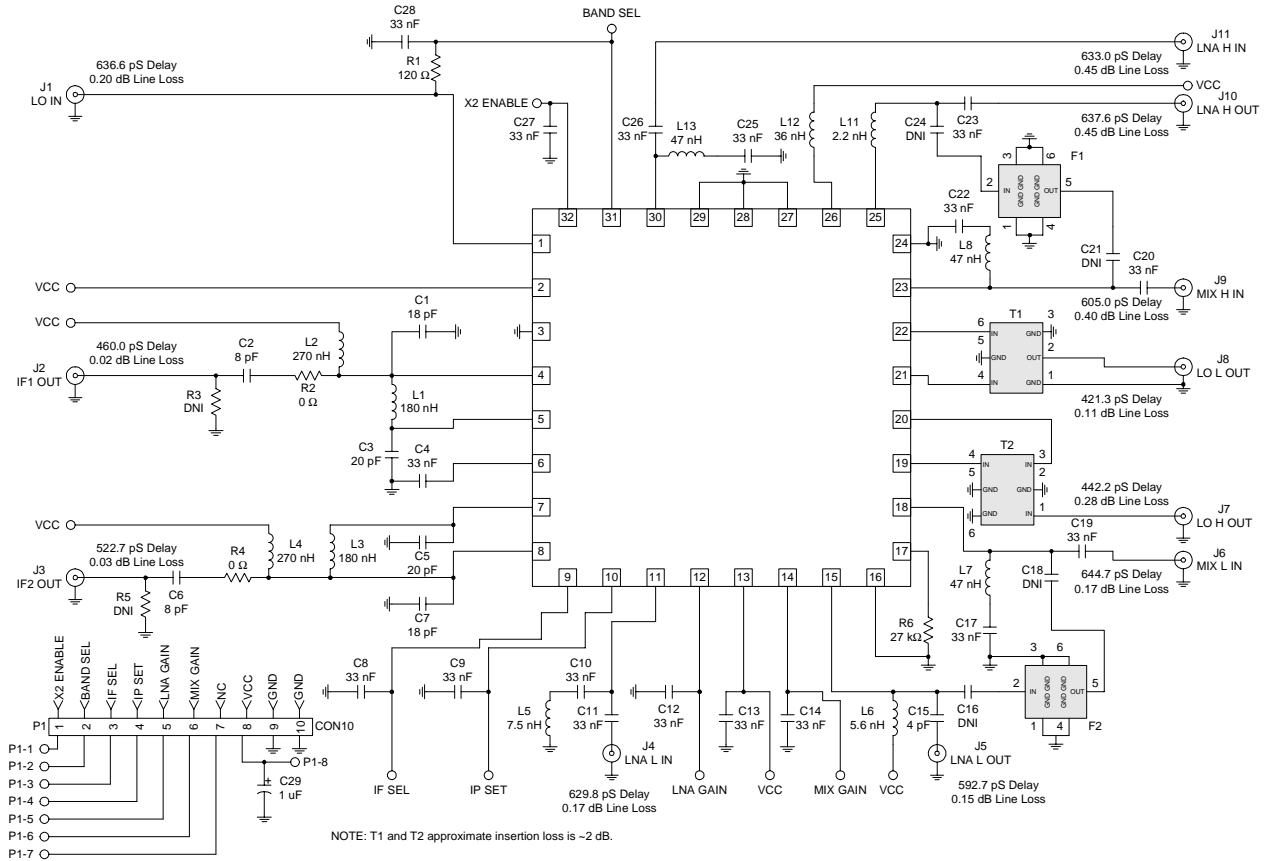

### Evaluation Board Layout Board Size 3.0" x 3.0"

Board Thickness 0.0616", Board Material FR-4, Multi-Layer  
Assembly

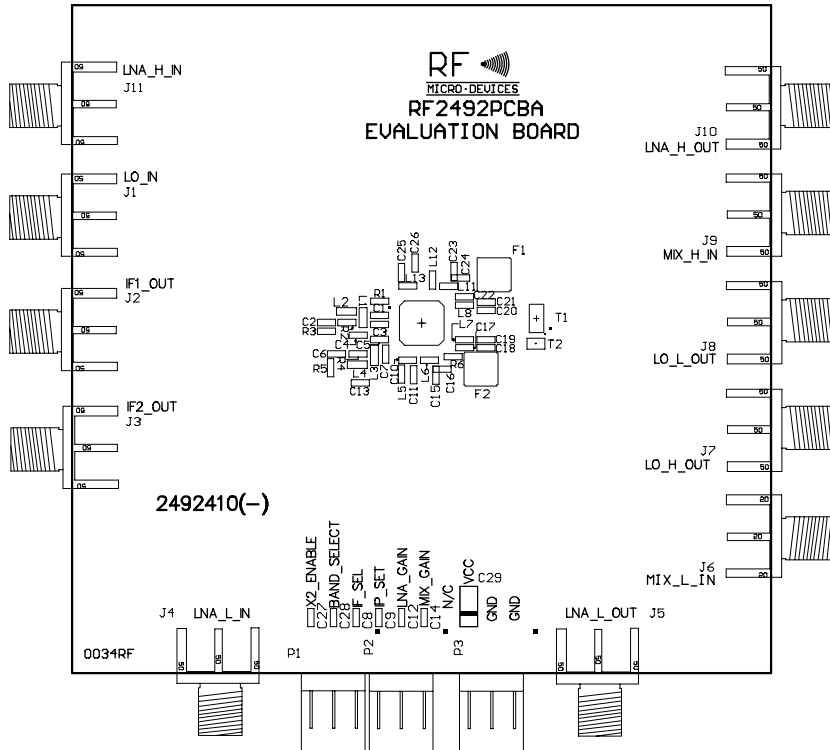

8  
FRONT-ENDS

Top

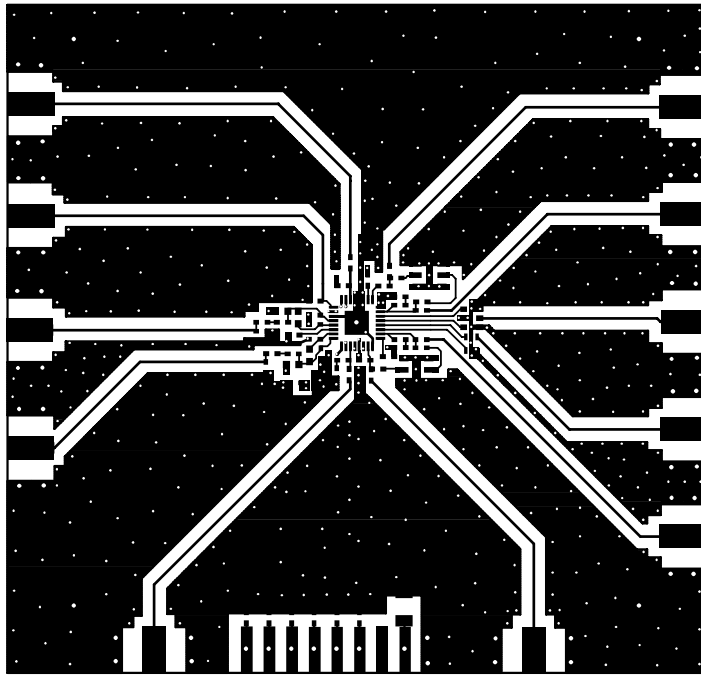

Typical Inner Layer

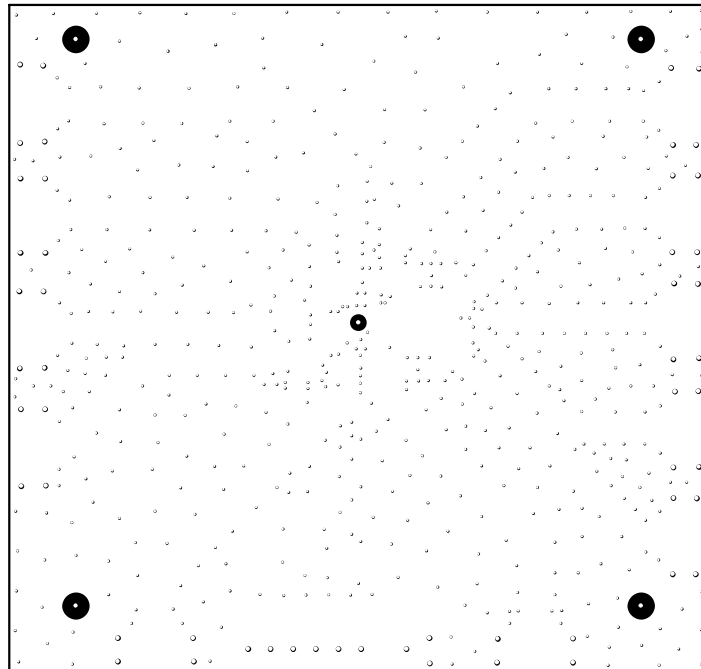

Back

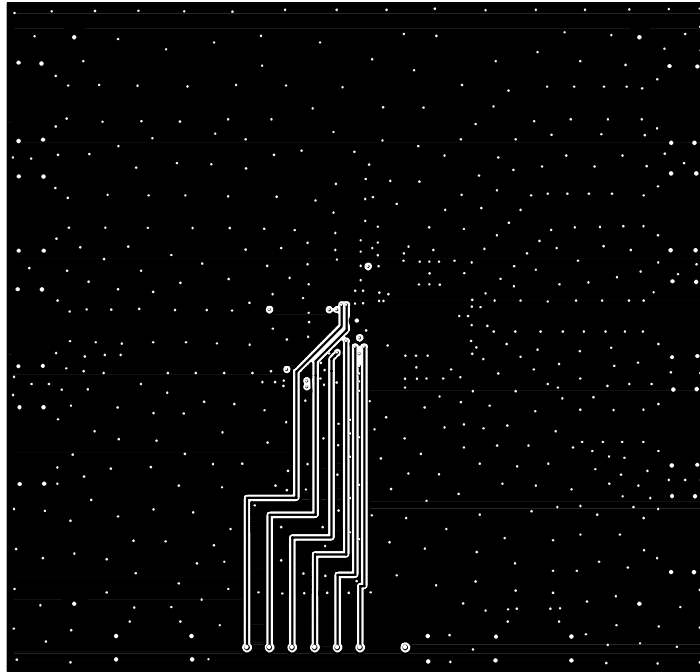

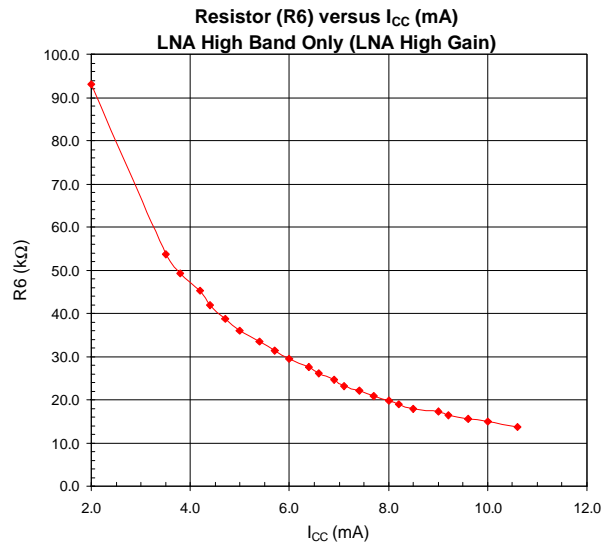
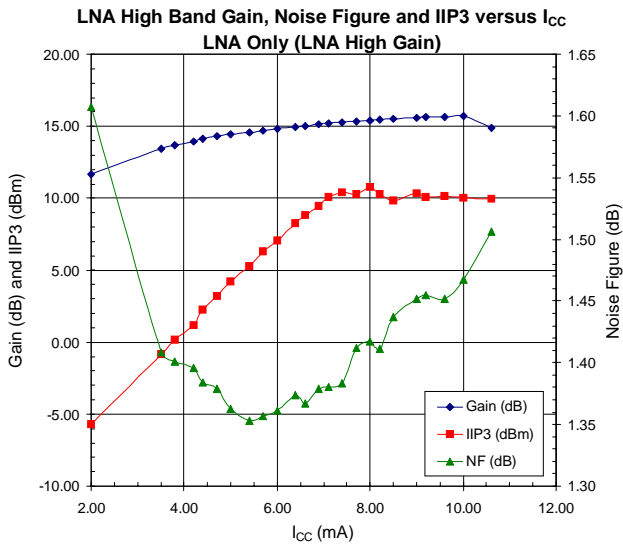
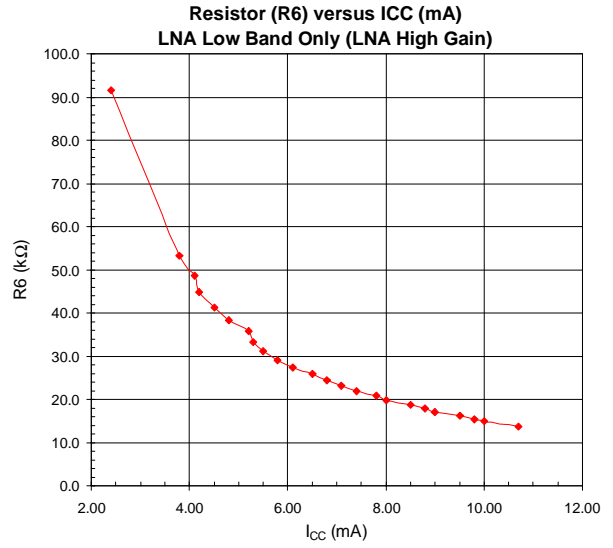
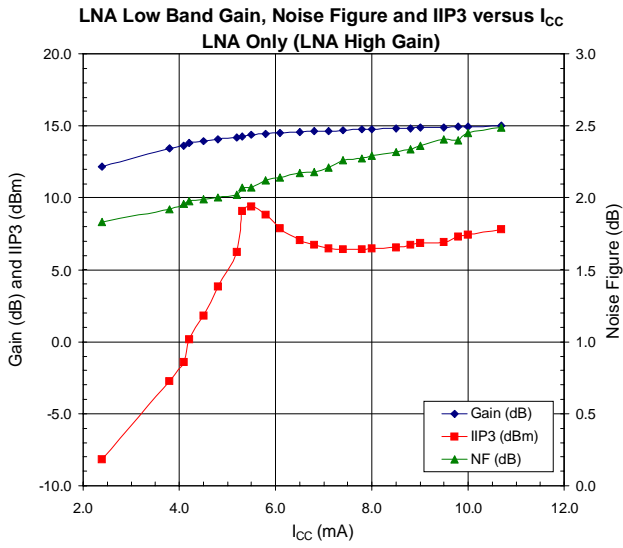

FRONT-ENDS

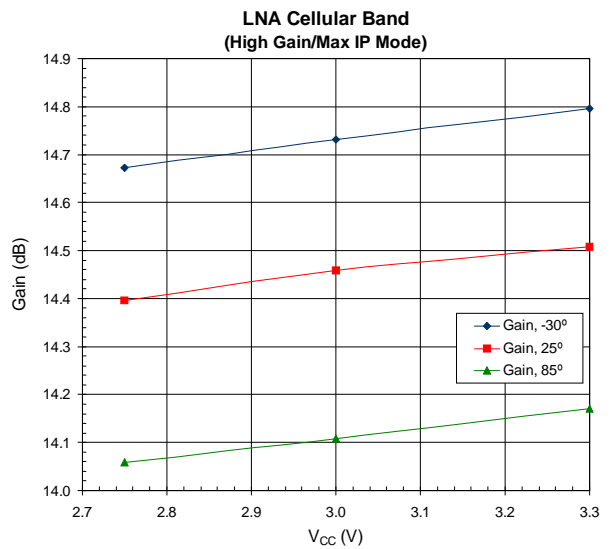
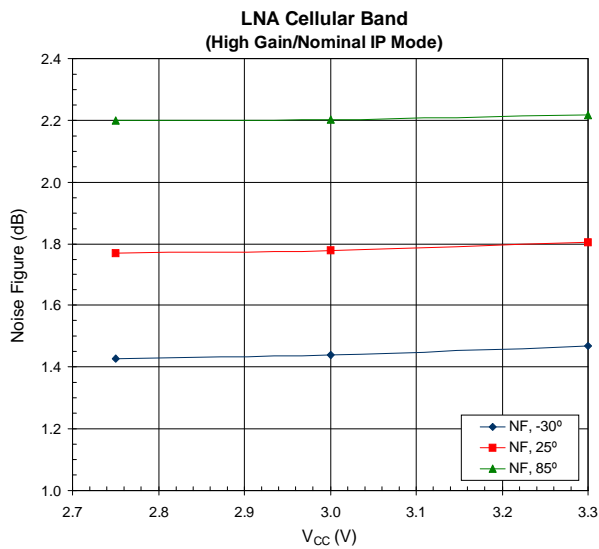
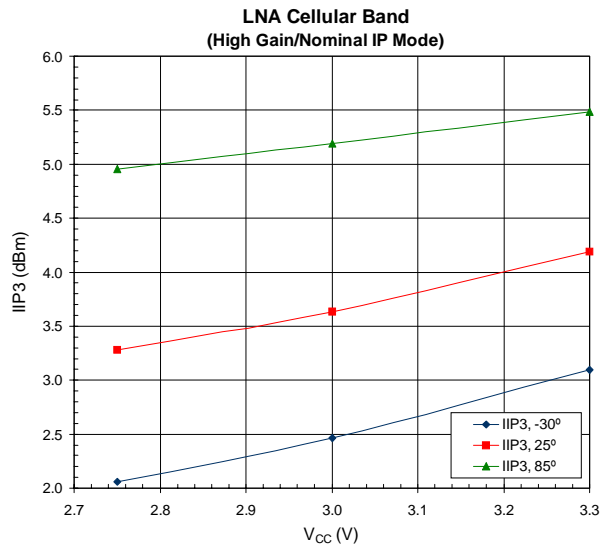
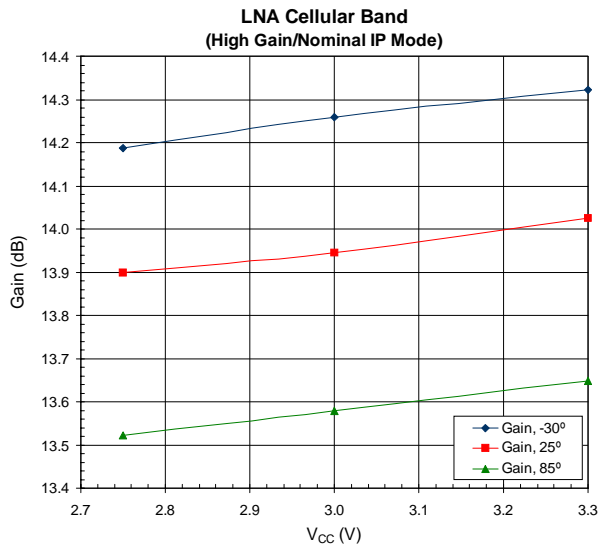
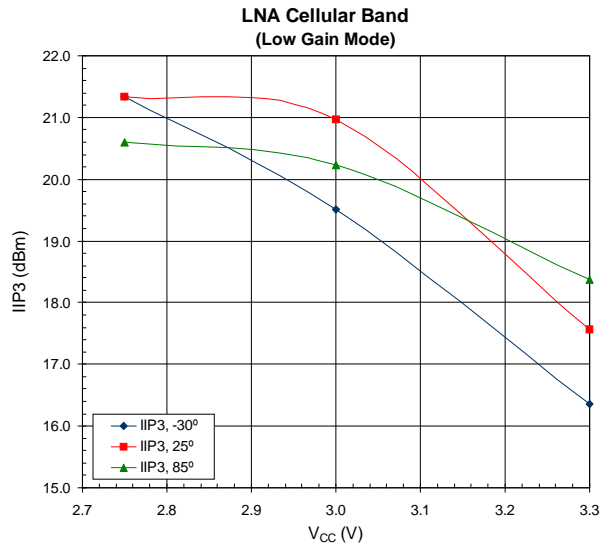
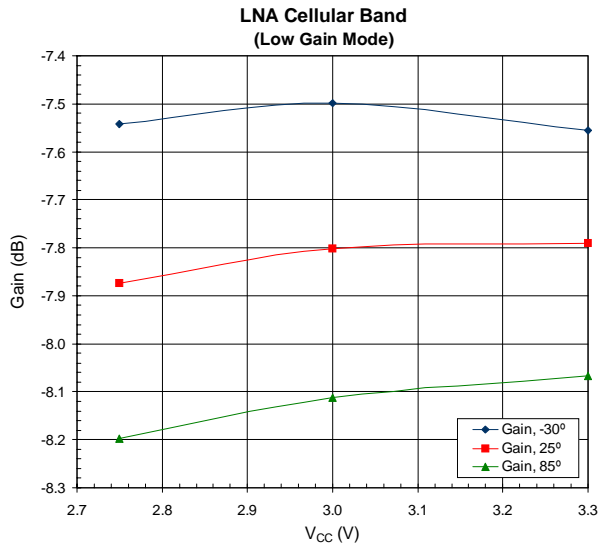

FRONT-ENDS

LNA Cellular Band  
(High Gain/Max IP Mode)

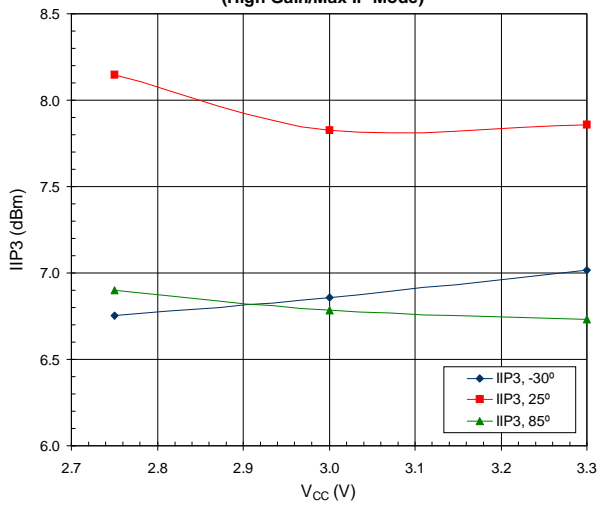

LNA Cellular Band  
(High Gain/Max IP Mode)

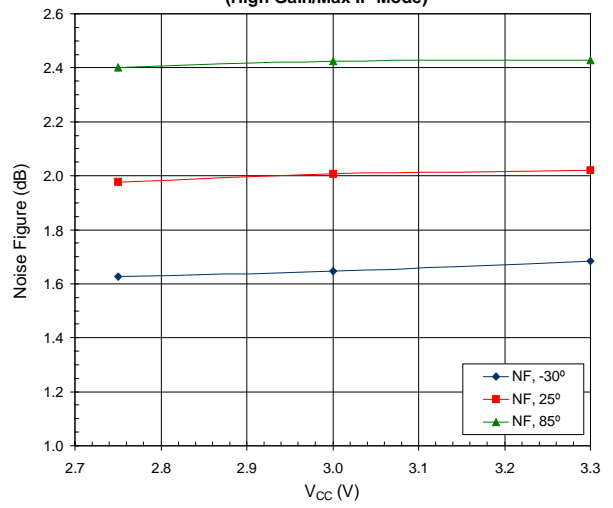

LNA Cellular Band  
(High Gain/Nominal IP Mode)

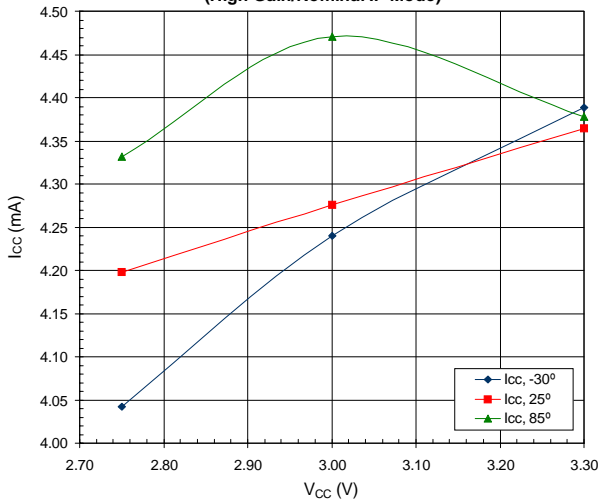

LNA Cellular Band  
(High Gain/Max IP Mode)

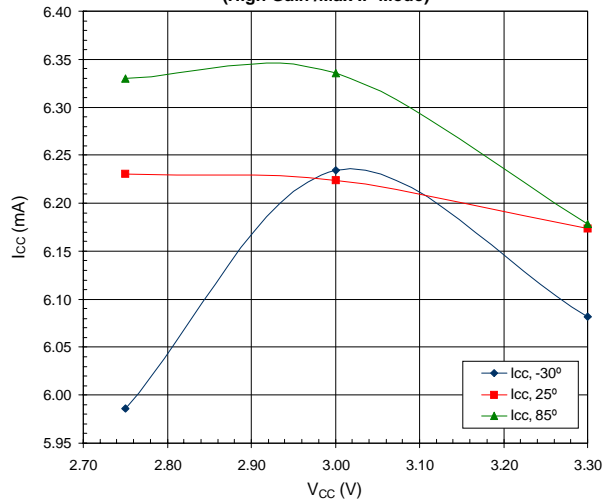



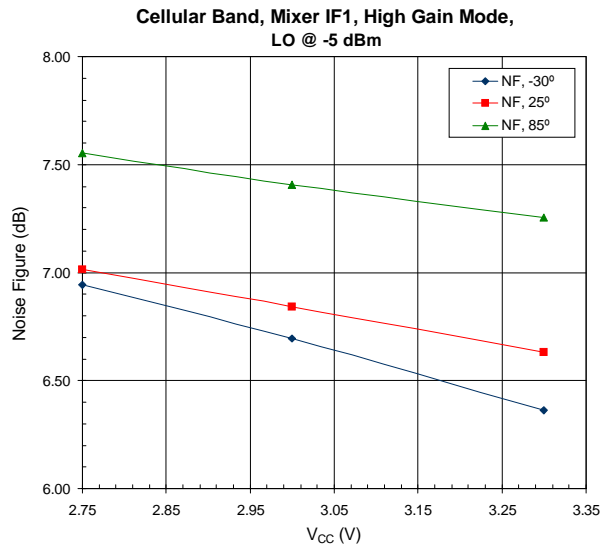
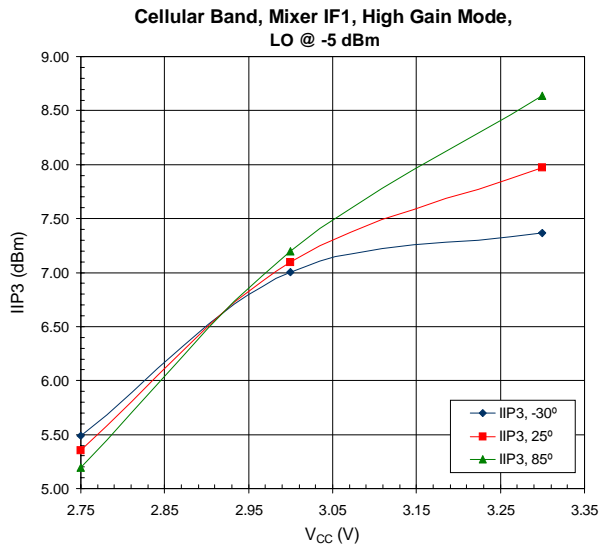
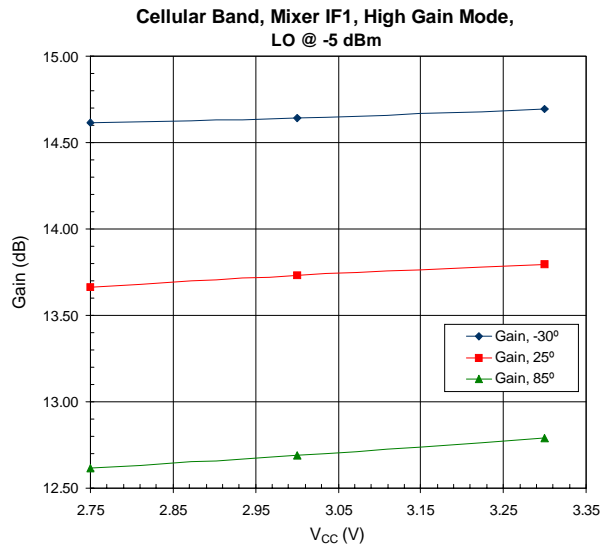
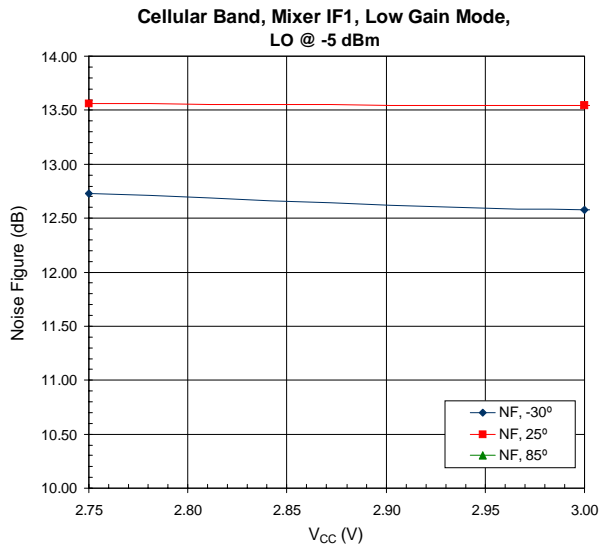
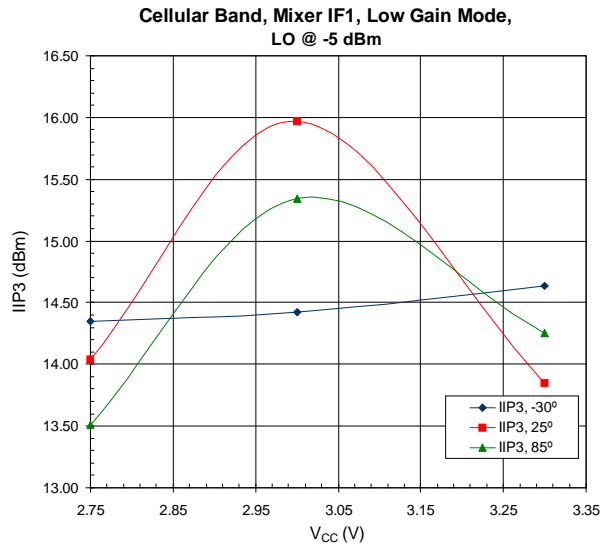
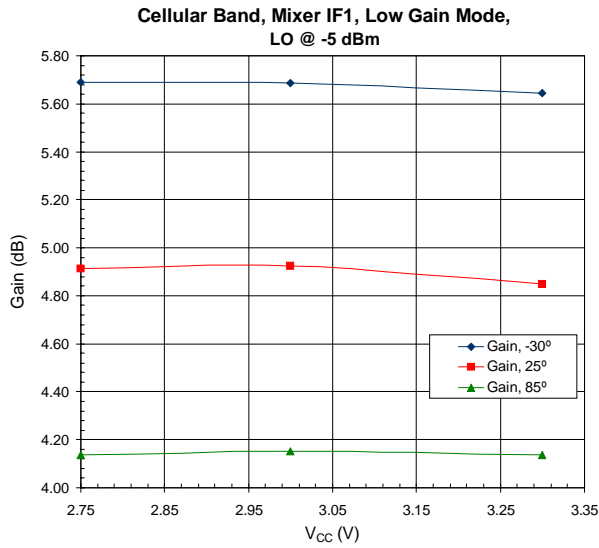

Cellular Band, Mixer IF1, High Gain Mode,  
LO @ -5 dBm

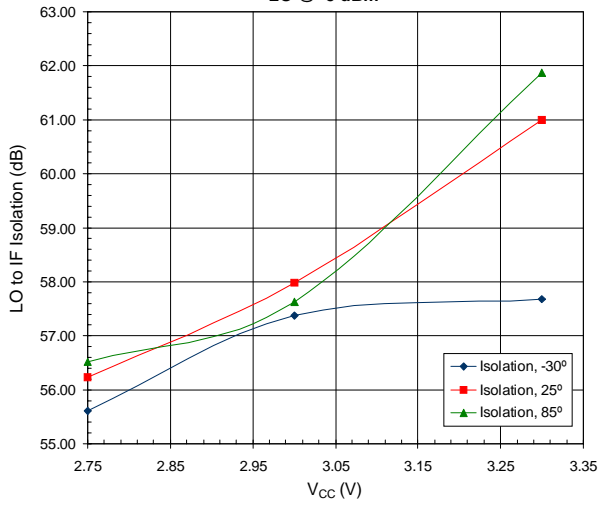

Cellular Band, Mixer IF1, High Gain Mode,  
Vcc @ 2.75 V

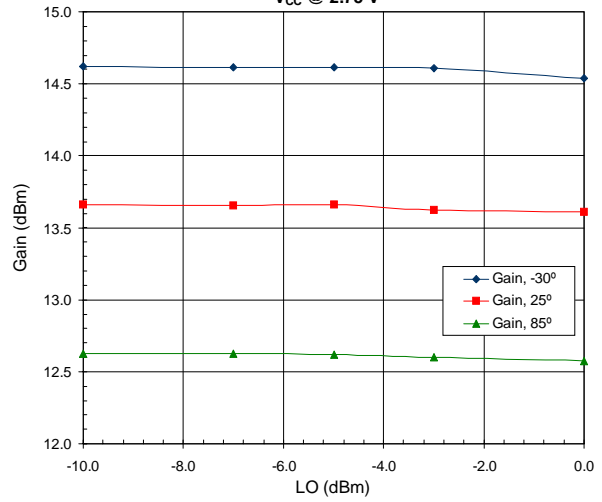

Cellular Band, Mixer IF1, High Gain Mode,  
Vcc = 2.75 V

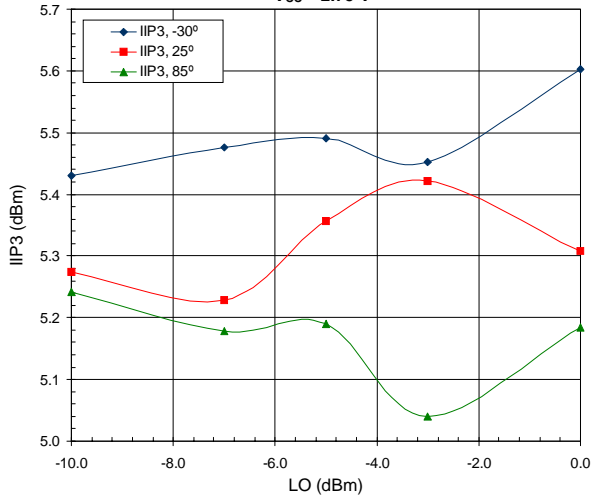

Cellular Band, Mixer IF1, High Gain Mode,  
LO @ -5 dBm

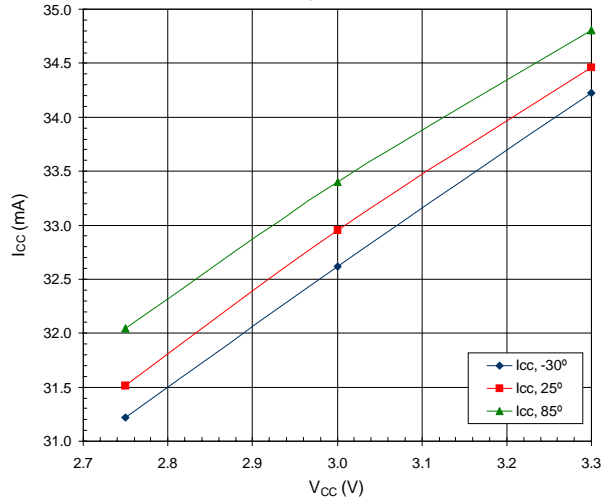

Cellular LO Buffer Output, LO<sub>IN</sub> @ -5 dBm  
(T1 Insertion Loss *Not* Taken Into Consideration)

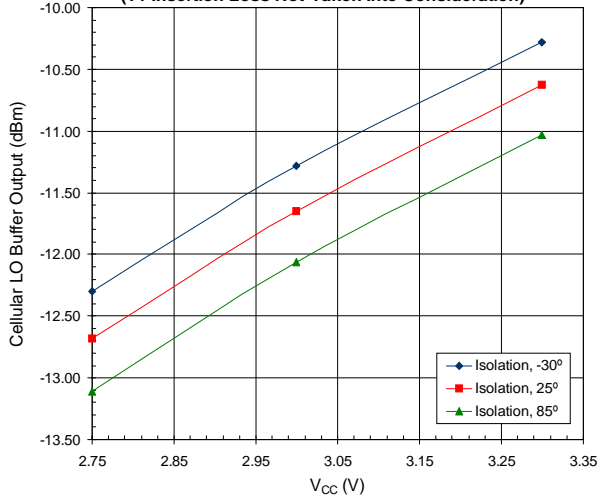

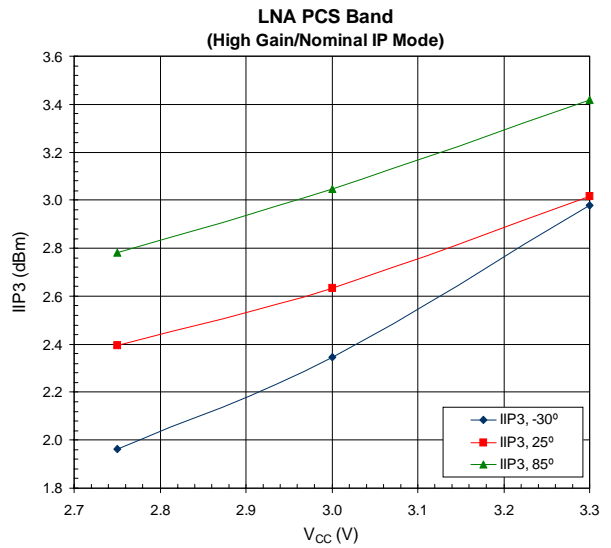
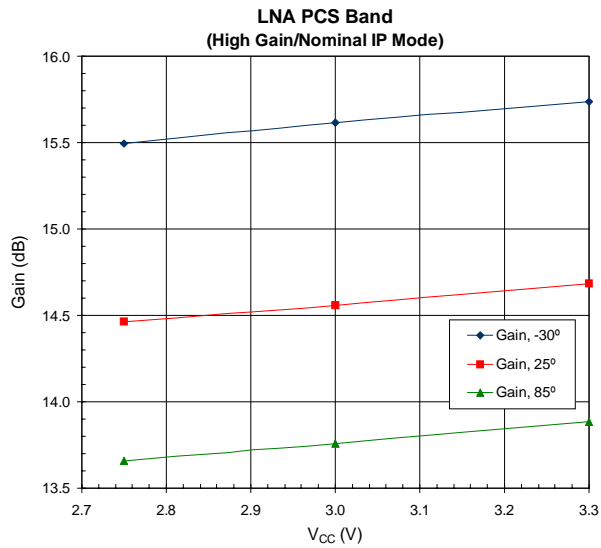
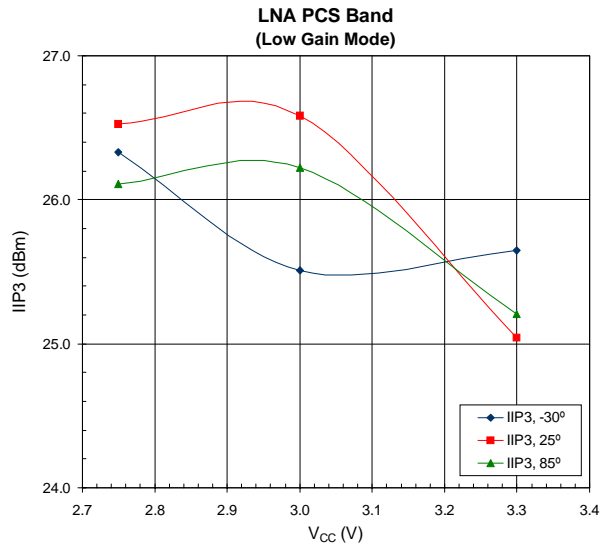
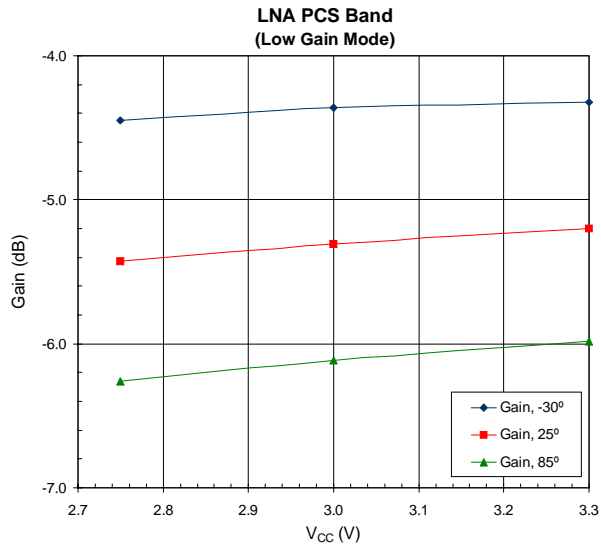

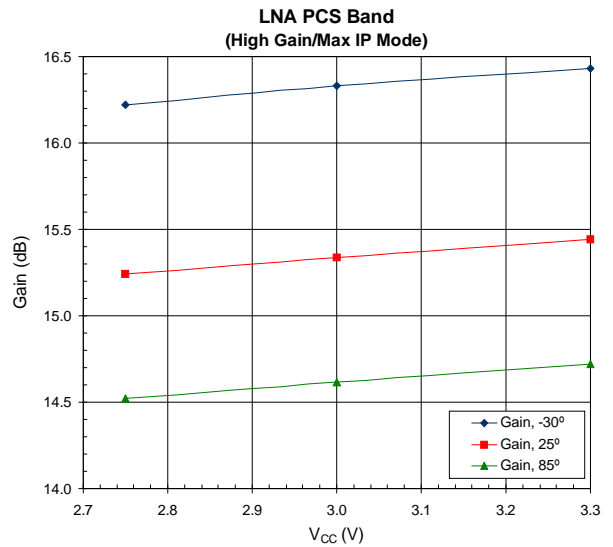
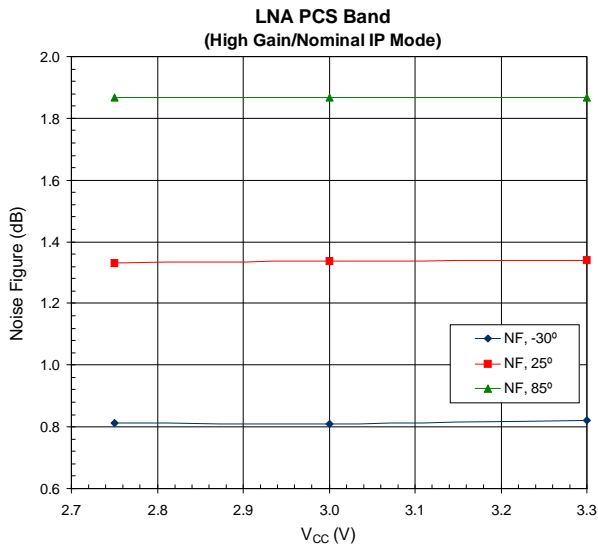
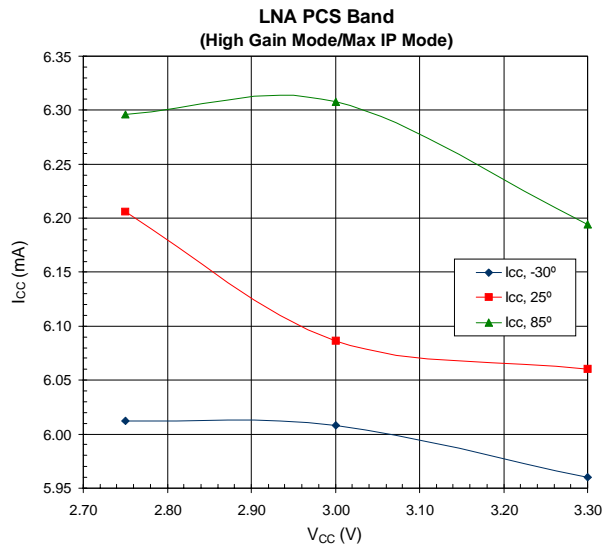
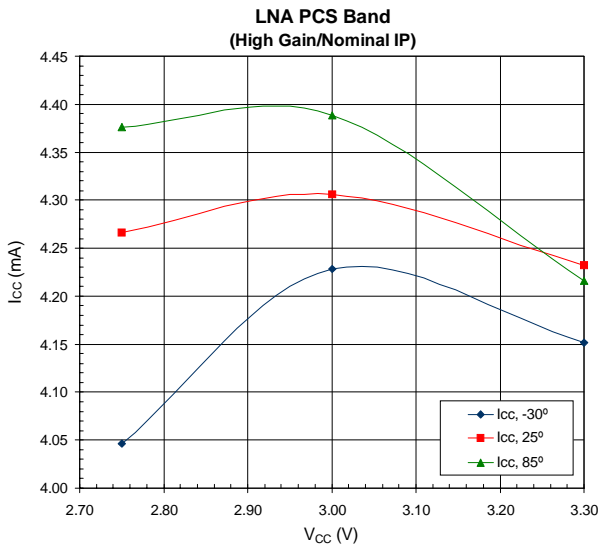
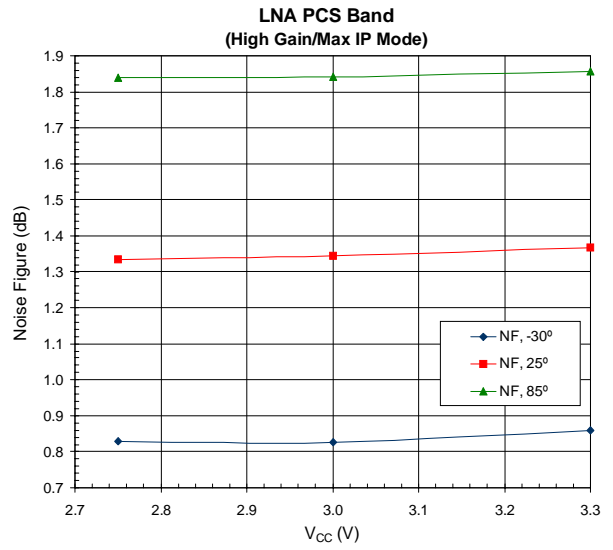
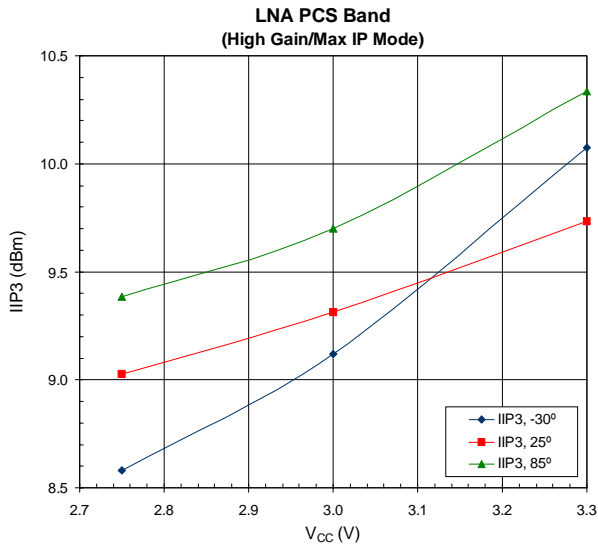

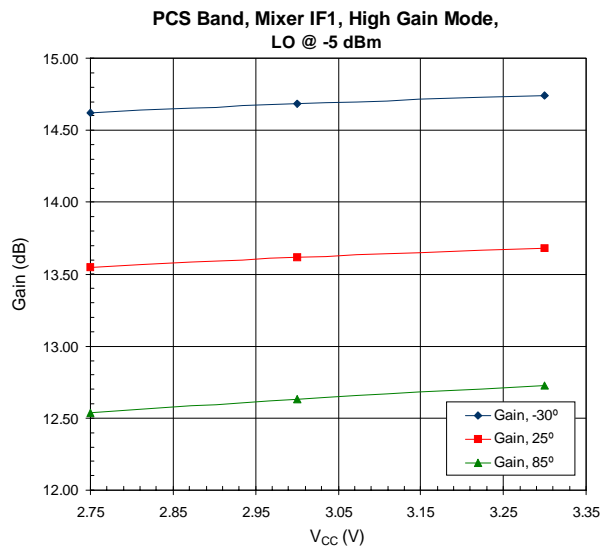
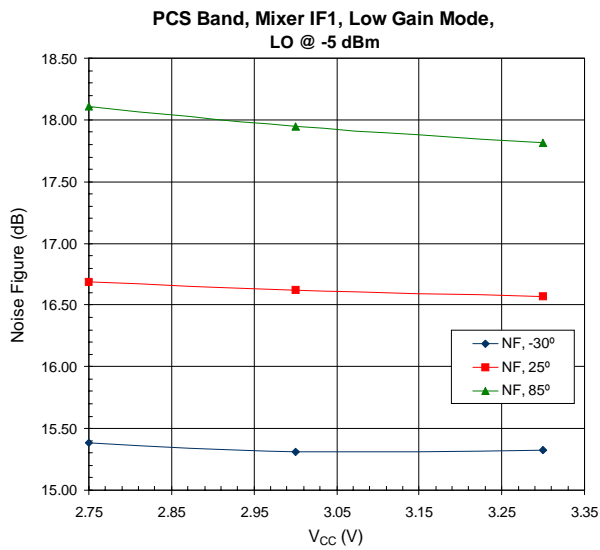

FRONT-ENDS

PCS Band, Mixer IF1, High Gain Mode,  
LO @ -5 dBm

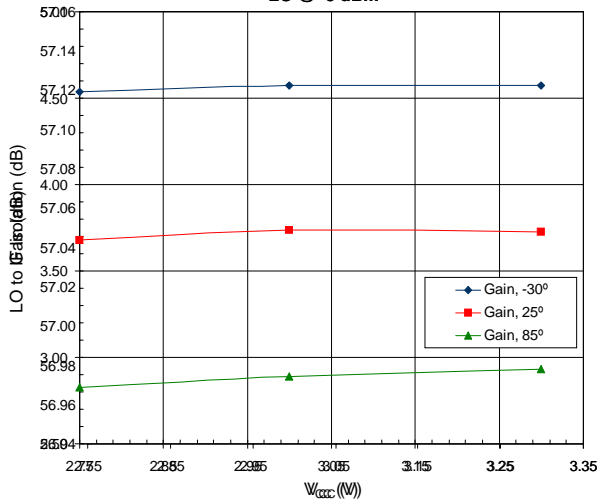

PCS Band, Mixer IF1, High Gain Mode,  
Vcc @ 2.75 V

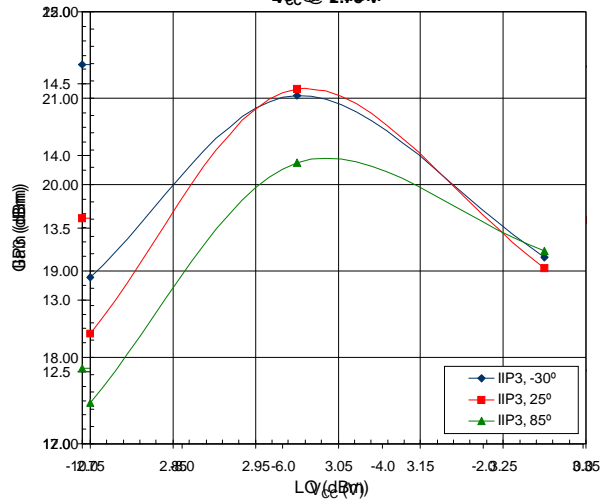

PCS Band, Mixer IF1, High Gain Mode,  
Vcc = 2.75 V

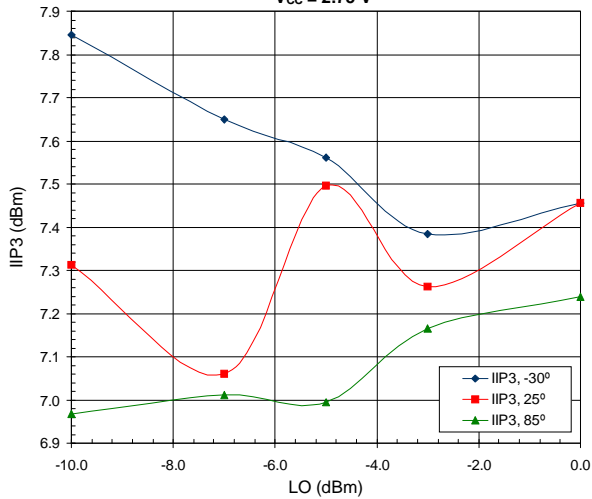

PCS Band, Mixer IF1, High Gain Mode,  
LO @ -5 dBm

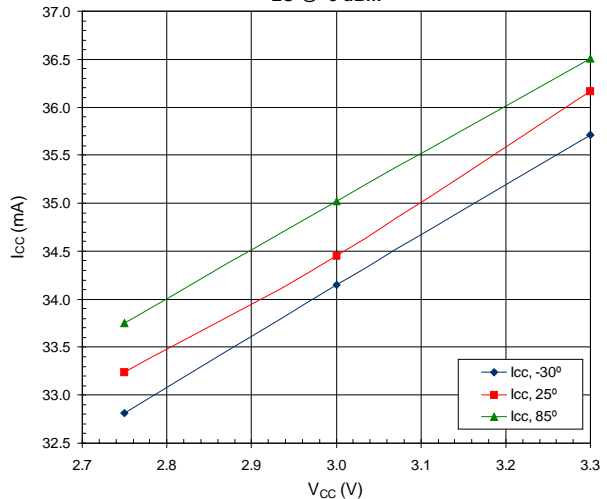

PCS Band, Mixer IF1, High Gain Mode,  
(T2 Insertion Loss Not Taken Into Consideration)

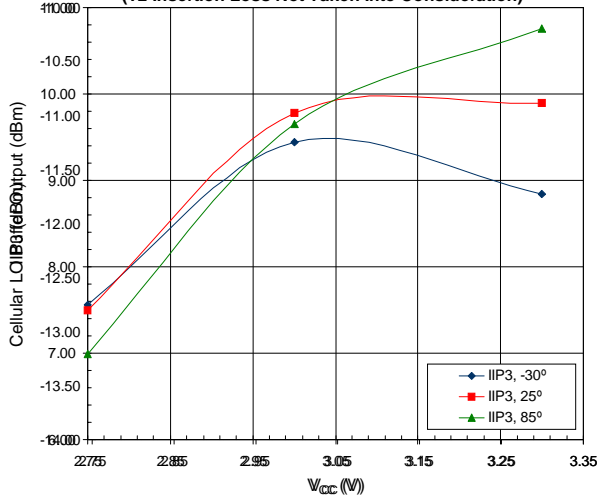

PCS Band, Mixer IF1, High Gain Mode,  
LO @ -5 dBm

