

SKM 300GB128D ...

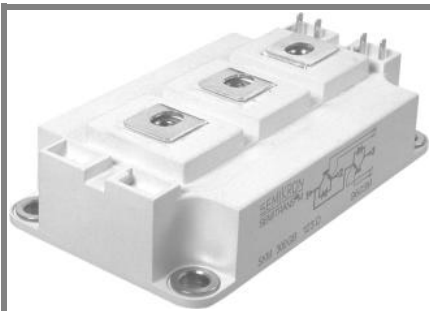

SEMITRANS® 3

SPT IGBT Module

SKM 300GB128D

SKM 300GAL128D

Features

- Homogeneous Si
- SPT = Soft-Punch-Through technology
- V_{CEsat} with positive temperature coefficient
- High short circuit capability, self limiting to $6 \times I_C$

Typical Applications

- AC inverter drives
- UPS
- Electronic welders at f_{sw} up to 20 kHz

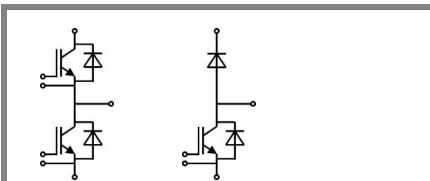

GB

GAL

Absolute Maximum Ratings		$T_C = 25\text{ }^\circ\text{C}$, unless otherwise specified		
Symbol	Conditions	Values		Units
IGBT				
V_{CES}	$T_j = 25\text{ }^\circ\text{C}$	1200		V
I_C	$T_j = 150\text{ }^\circ\text{C}$	$T_C = 25\text{ }^\circ\text{C}$	370	A
		$T_C = 80\text{ }^\circ\text{C}$	265	A
I_{CRM}	$I_{CRM} = 2 \times I_{Cnom}$	400		A
V_{GES}		± 20		V
t_{psc}	$V_{CC} = 600\text{ V}; V_{GE} \leq 20\text{ V}; T_j = 125\text{ }^\circ\text{C}$ $V_{CES} < 1200\text{ V}$	10		μs
Inverse Diode				
I_F	$T_j = 150\text{ }^\circ\text{C}$	$T_{case} = 25\text{ }^\circ\text{C}$	260	A
		$T_{case} = 80\text{ }^\circ\text{C}$	180	A
I_{FRM}	$I_{FRM} = 2 \times I_{Fnom}$	400		A
I_{FSM}	$t_p = 10\text{ ms}; \text{sin.}$	$T_j = 150\text{ }^\circ\text{C}$	1800	A
Freewheeling Diode				
I_F	$T_j = 150\text{ }^\circ\text{C}$	$T_{case} = 25\text{ }^\circ\text{C}$	260	A
		$T_{case} = 80\text{ }^\circ\text{C}$	180	A
I_{FRM}	$I_{FRM} = 2 \times I_{Fnom}$	400		A
I_{FSM}	$t_p = 10\text{ ms}; \text{sin.}$	$T_j = 150\text{ }^\circ\text{C}$	1800	A
Module				
$I_{t(RMS)}$		500		A
T_{vj}		- 40...+ 150		$^\circ\text{C}$
T_{stg}		- 40...+ 125		$^\circ\text{C}$
V_{isol}	AC, 1 min.	4000		V

Characteristics		$T_C = 25\text{ }^\circ\text{C}$, unless otherwise specified			
Symbol	Conditions	min.	typ.	max.	Units
IGBT					
$V_{GE(th)}$	$V_{GE} = V_{CE}, I_C = 8\text{ mA}$	4,5	5,5	6,5	V
I_{CES}	$V_{GE} = 0\text{ V}, V_{CE} = V_{CES}$		0,2	0,6	mA
V_{CE0}		$T_j = 25\text{ }^\circ\text{C}$	1	1,15	V
		$T_j = 125\text{ }^\circ\text{C}$	0,9	1,05	V
r_{CE}	$V_{GE} = 15\text{ V}$	$T_j = 25\text{ }^\circ\text{C}$	4,5	6	m Ω
		$T_j = 125\text{ }^\circ\text{C}$	6	7,5	m Ω
$V_{CE(sat)}$	$I_{Cnom} = 200\text{ A}, V_{GE} = 15\text{ V}$	$T_j = 25\text{ }^\circ\text{C}_{chiplev.}$	1,9	2,35	V
		$T_j = 125\text{ }^\circ\text{C}_{chiplev.}$	2,1	2,55	V
C_{ies}	$V_{CE} = 25, V_{GE} = 0\text{ V}$	$f = 1\text{ MHz}$	17		nF
C_{oes}			2		nF
C_{res}			1,9		nF
Q_G	$V_{GE} = -8\text{ V} - +20\text{ V}$	2400		nC	
R_{Gint}	$T_j = 25\text{ }^\circ\text{C}$	2		Ω	
$t_{d(on)}$	$R_{Gon} = 5\text{ }^\circ\Omega$	$V_{CC} = 600\text{ V}$ $I_{Cnom} = 200\text{ A}$	170		ns
			$T_j = 125\text{ }^\circ\text{C}$	55	ns
E_{on}	$R_{Goff} = 5\text{ }^\circ\Omega$	$V_{GE} = \pm 15\text{ V}$ $I_s = 20\text{ nH}$	22		mJ
$t_{d(off)}$			660		ns
t_f			60		ns
E_{off}	per IGBT		22		mJ
$R_{th(j-c)}$			0,085		K/W

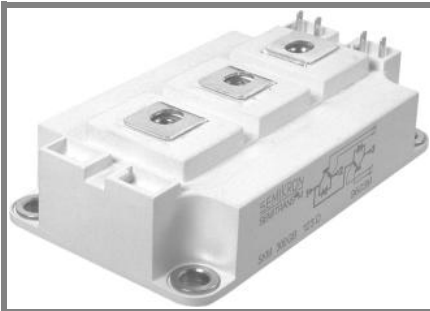

SEMITRANS® 3

SPT IGBT Module

SKM 300GB128D

SKM 300GAL128D

Features

- Homogeneous Si
- SPT = Soft-Punch-Through technology
- V_{CEsat} with positive temperature coefficient
- High short circuit capability, self limiting to $6 \times I_c$

Typical Applications

- AC inverter drives
- UPS
- Electronic welders at f_{sw} up to 20 kHz

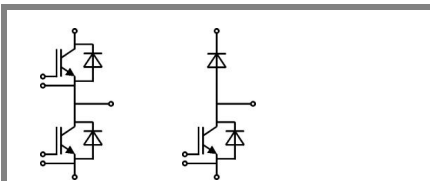

GB

GAL

Characteristics					
Symbol	Conditions	min.	typ.	max.	Units
Inverse Diode					
$V_F = V_{EC}$	$I_{Fnom} = 200 \text{ A}; V_{GE} = 0 \text{ V}$	$T_j = 25 \text{ }^\circ\text{C}_{chiplev.}$	2	2,5	V
		$T_j = 125 \text{ }^\circ\text{C}_{chiplev.}$	1,8		V
V_{F0}		$T_j = 25 \text{ }^\circ\text{C}$	1,1	1,2	V
r_F		$T_j = 25 \text{ }^\circ\text{C}$	4,5	6,5	mΩ
I_{RRM}	$I_{Fnom} = 200 \text{ A}$	$T_j = 125 \text{ }^\circ\text{C}$	280		A
Q_{rr}	$di/dt = 6300 \text{ A}/\mu\text{s}$	$L_S = 20 \text{ nH}$	33		μC
E_{rr}	$V_{GE} = -15 \text{ V}; V_{CC} = 600 \text{ V}$		11		mJ
$R_{th(j-c)D}$	per diode			0,18	K/W
FWD					
$V_F = V_{EC}$	$I_{Fnom} = 200 \text{ A}; V_{GE} = 0 \text{ V}$	$T_j = 25 \text{ }^\circ\text{C}_{chiplev.}$	2	2,5	V
		$T_j = 125 \text{ }^\circ\text{C}_{chiplev.}$	1,8		V
V_{F0}		$T_j = 25 \text{ }^\circ\text{C}$	1,1	1,2	V
r_F		$T_j = 25 \text{ }^\circ\text{C}$	4,5	6,5	V
I_{RRM}	$I_{Fnom} = 200 \text{ A}$	$T_j = 25 \text{ }^\circ\text{C}$	280		A
Q_{rr}	$di/dt = 6300 \text{ A}/\mu\text{s}$	$L_S = 20 \text{ nH}$	33		μC
E_{rr}	$V_{GE} = -15 \text{ V}; V_{CC} = 600 \text{ V}$		11		mJ
$R_{th(j-c)FD}$	per diode			0,18	K/W
Module					
L_{CE}			15	20	nH
$R_{CC+EE'}$	res., terminal-chip	$T_{case} = 25 \text{ }^\circ\text{C}$	0,35		mΩ
		$T_{case} = 125 \text{ }^\circ\text{C}$	0,5		mΩ
$R_{th(c-s)}$	per module			0,038	K/W
M_s	to heat sink M6		3	5	Nm
M_t	to terminals M6		2,5	5	Nm
w				325	g

This is an electrostatic discharge sensitive device (ESDS), international standard IEC 60747-1, Chapter IX.

This technical information specifies semiconductor devices but promises no characteristics. No warranty or guarantee expressed or implied is made regarding delivery, performance or suitability.

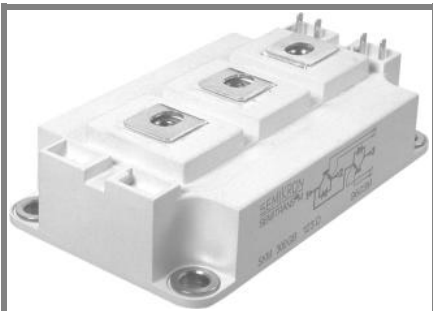

SEMITRANS® 3

SPT IGBT Module

SKM 300GB128D

SKM 300GAL128D

Features

- Homogeneous Si
- SPT = Soft-Punch-Through technology
- V_{CEsat} with positive temperature coefficient
- High short circuit capability, self limiting to $6 \times I_c$

Typical Applications

- AC inverter drives
- UPS
- Electronic welders at f_{sw} up to 20 kHz

Z_{th} Symbol	Conditions	Values	Units
$Z_{th(j-c)I}$			
$R_{\theta j-c}$	$i = 1$	55	mk/W
$R_{\theta j-c}$	$i = 2$	26	mk/W
$R_{\theta j-c}$	$i = 3$	3,5	mk/W
$R_{\theta j-c}$	$i = 4$	0,5	mk/W
$\tau_{\theta j-c}$	$i = 1$	0,04	s
$\tau_{\theta j-c}$	$i = 2$	0,189	s
$\tau_{\theta j-c}$	$i = 3$	0,0017	s
$\tau_{\theta j-c}$	$i = 4$	0,003	s
$Z_{th(j-c)D}$			
$R_{\theta j-c}$	$i = 1$	120	mk/W
$R_{\theta j-c}$	$i = 2$	48	mk/W
$R_{\theta j-c}$	$i = 3$	10	mk/W
$R_{\theta j-c}$	$i = 4$	2	mk/W
$\tau_{\theta j-c}$	$i = 1$	0,0727	s
$\tau_{\theta j-c}$	$i = 2$	0,006	s
$\tau_{\theta j-c}$	$i = 3$	0,0078	s
$\tau_{\theta j-c}$	$i = 4$	0,0002	s

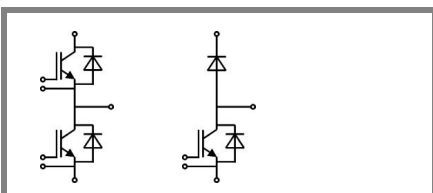

GB

GAL

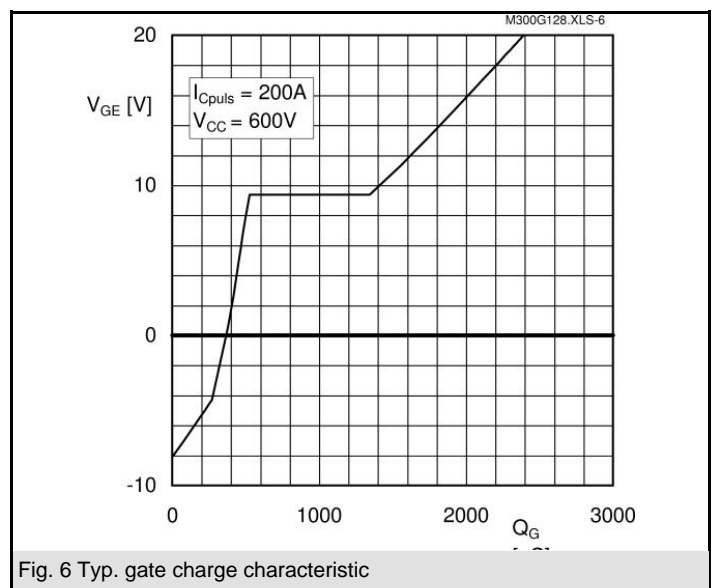
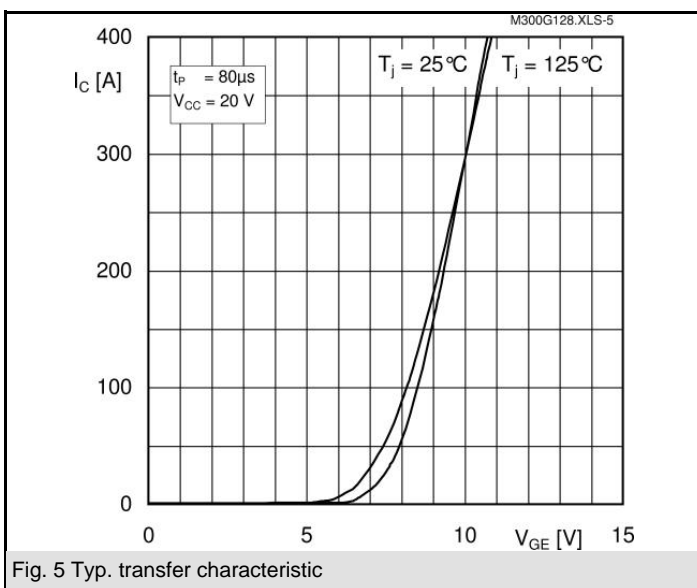
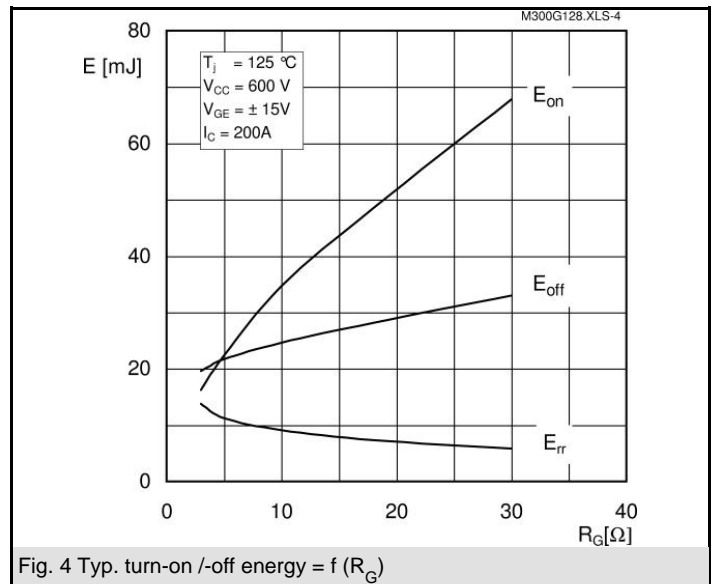
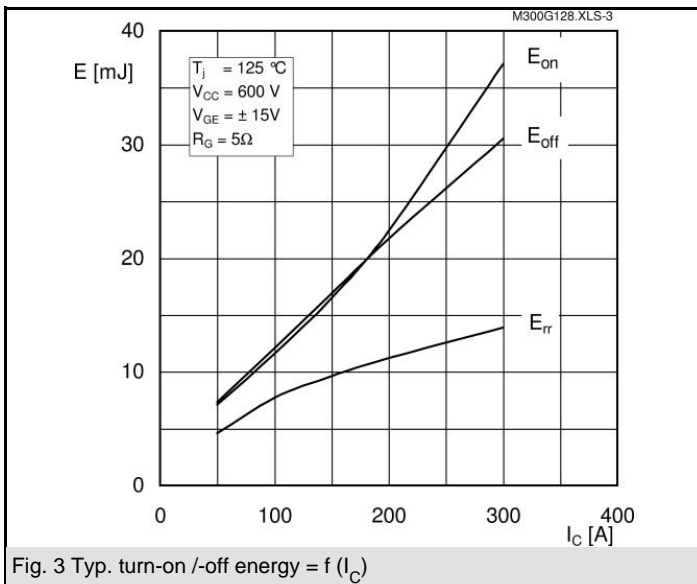
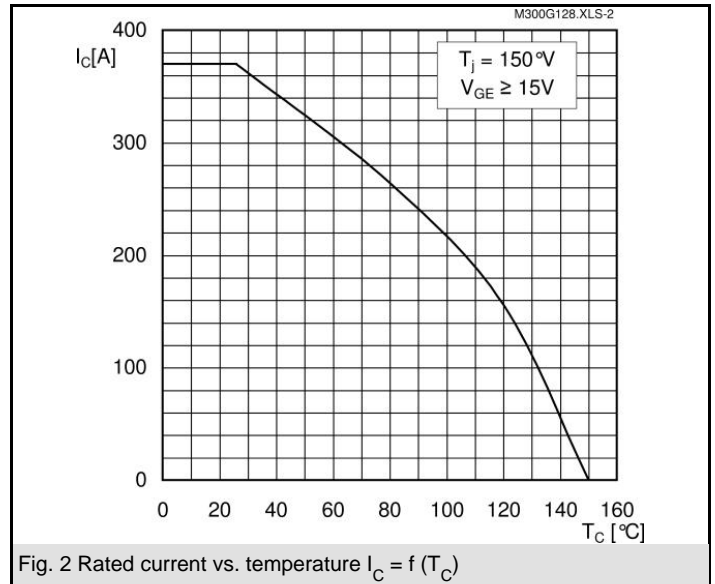
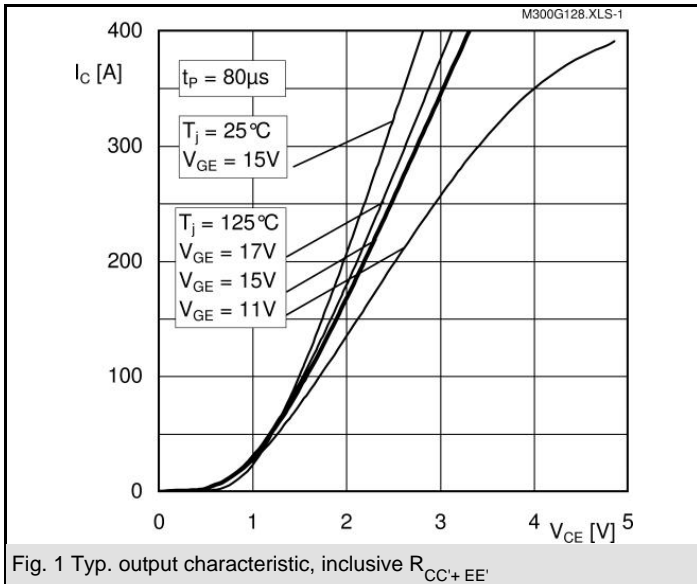

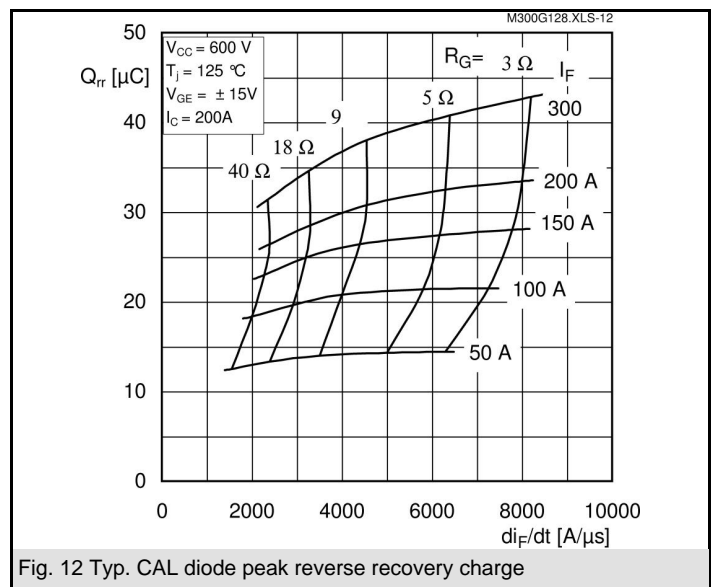
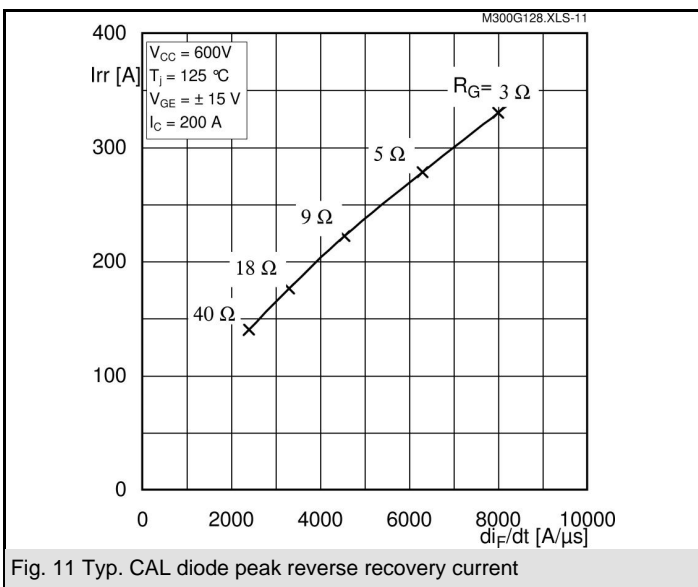
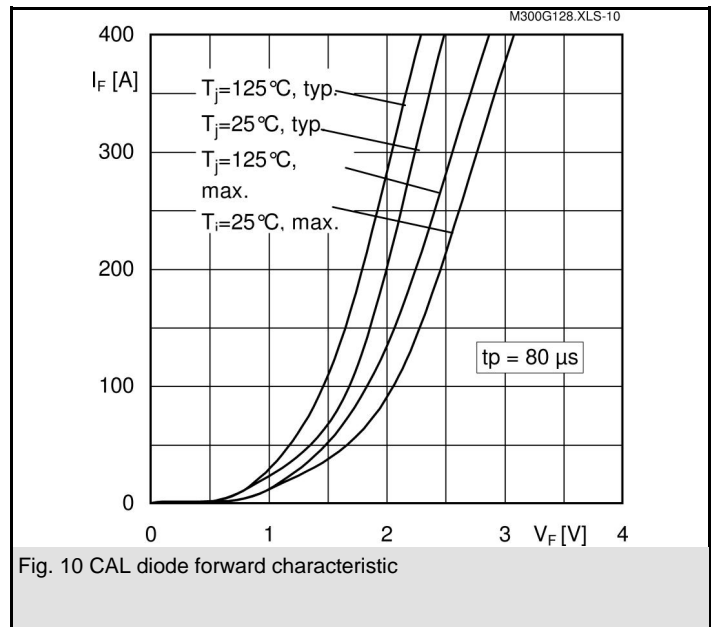
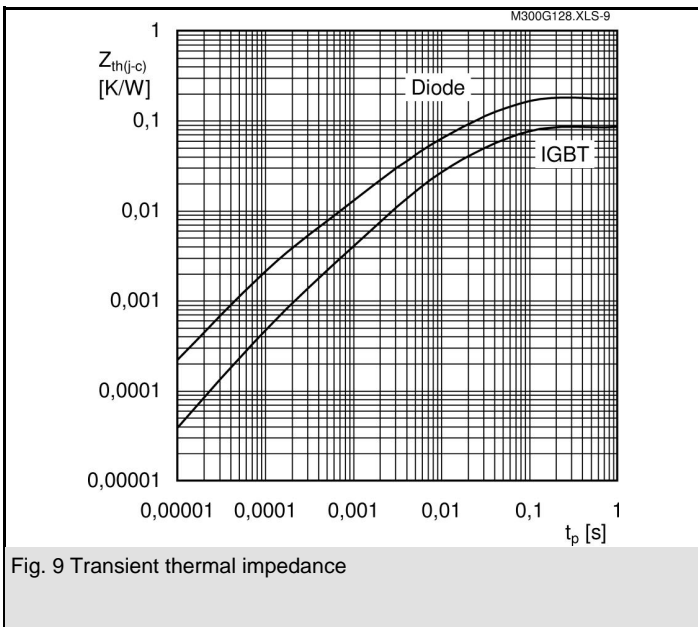
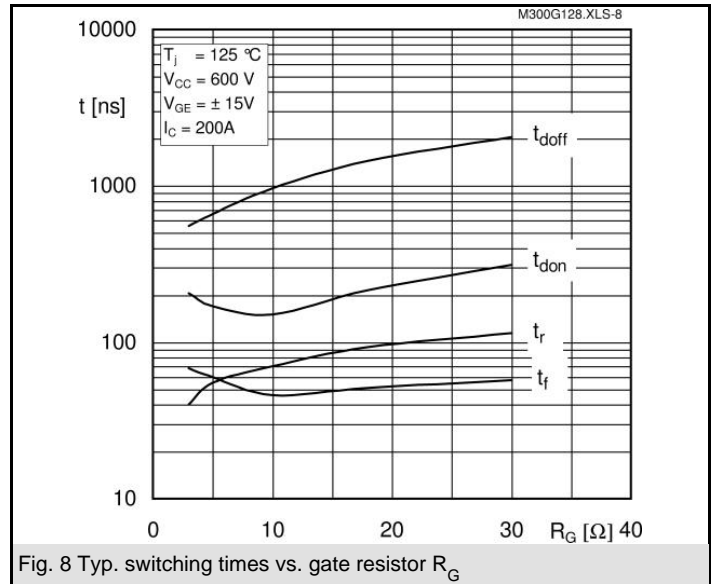
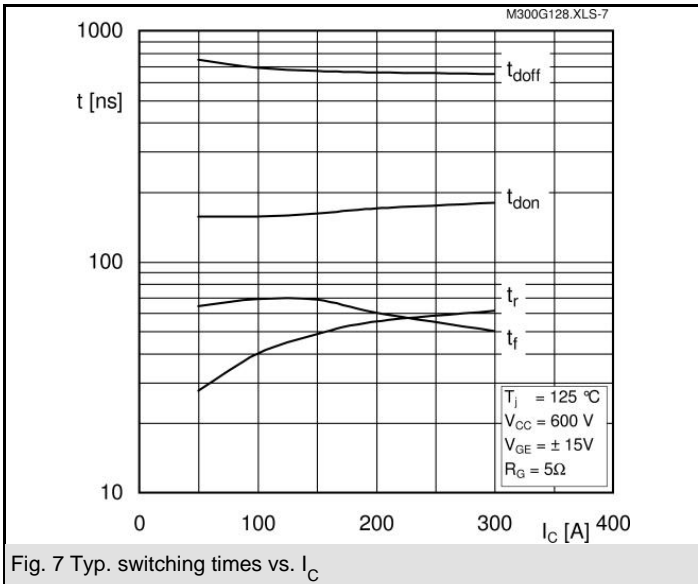

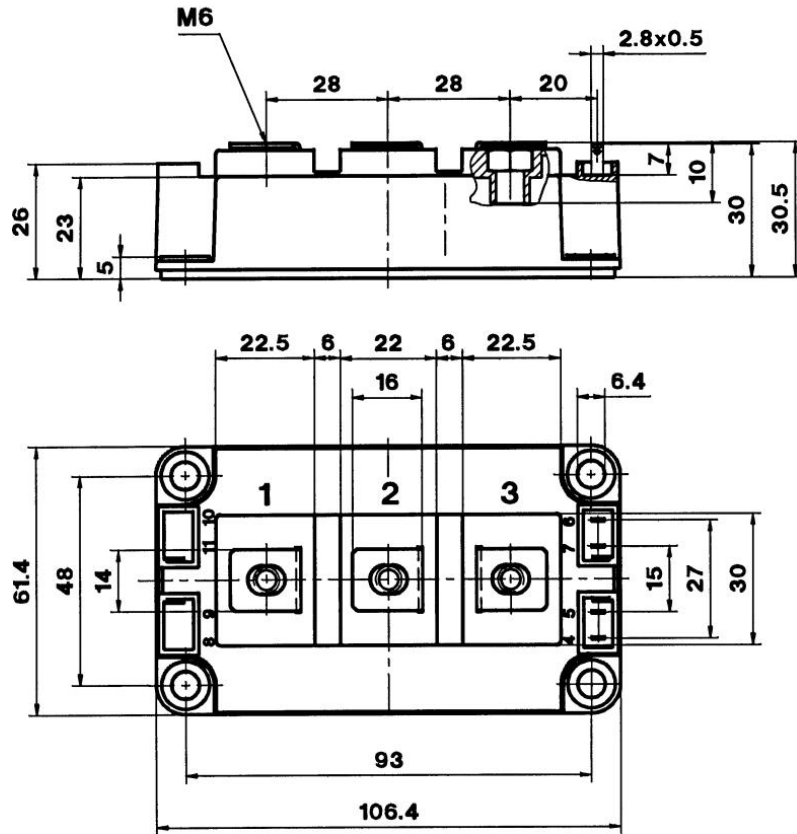

Case D 56

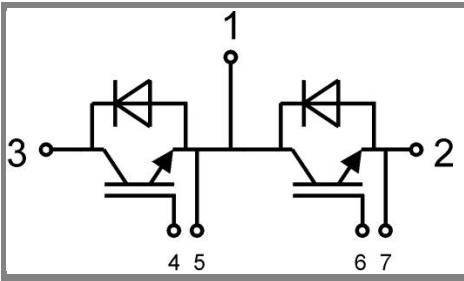

Case D56

GB

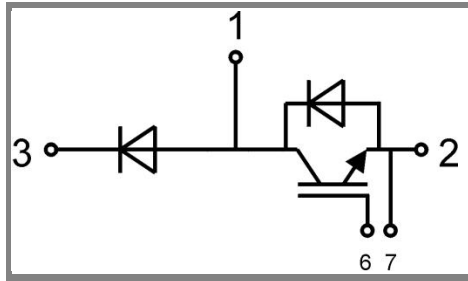

Case D57

GAL