

International IOR Rectifier

12CWQ10FNPbF

SCHOTTKY RECTIFIER

12 Amp

$I_{F(AV)} = 12\text{Amp}$
 $V_R = 100\text{V}$

Major Ratings and Characteristics

Characteristics	Values	Units
$I_{F(AV)}$ Rectangular waveform	12	A
V_{RRM}	100	V
I_{FSM} @ tp = 5 μ s sine	330	A
V_F @6 Apk, $T_J = 125^\circ\text{C}$ (per leg)	0.65	V
T_J range	-55 to 150	$^\circ\text{C}$

Description/ Features

The 12CWQ10FNPbF surface mount, center tap, Schottky rectifier series has been designed for applications requiring low forward drop and small foot prints on PC board. Typical applications are in disk drives, switching power supplies, converters, free-wheeling diodes, battery charging, and reverse battery protection.

- Popular D-PAK outline
- Center tap configuration
- Small foot print, surface mountable
- Low forward voltage drop
- High frequency operation
- Guard ring for enhanced ruggedness and long term reliability
- Lead-Free ("PbF" suffix)

Case Styles

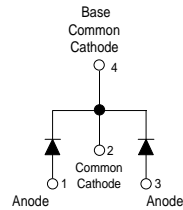

D-PAK (TO-252AA)

Voltage Ratings

Partnumber	12CWQ10FNPbF
V_R Max. DC Reverse Voltage (V)	100
V_{RWM} Max. Working Peak Reverse Voltage (V)	

Absolute Maximum Ratings

Parameters	12CWQ...	Units	Conditions
$I_{F(AV)}$ Max. Average Forward Current * See Fig. 5 (Per Leg) (Per Device)	6 12	A	50% duty cycle @ $T_C = 135^\circ\text{C}$, rectangular wave form
I_{FSM} Max. Peak One Cycle Non-Repetitive Surge Current * See Fig. 7 (Per Leg)	330	A	Following any rated load condition and with rated V_{RWM} applied
	110		
E_{AS} Non-Repetit. Avalanche Energy (Per Leg)	6	mJ	$T_J = 25^\circ\text{C}$, $I_{AS} = 1$ Amps, $L = 12$ mH
I_{AR} Repetitive Avalanche Current (Per Leg)	1	A	Current decaying linearly to zero in 1 μsec Frequency limited by $T_{J,max}$. $V_A = 1.5 \times V_R$ typical

Electrical Specifications

Parameters	12CWQ...	Units	Conditions
V_{FM} Max. Forward Voltage Drop (Per Leg) * See Fig. 1 (1)	0.80	V	@ 6A $T_J = 25^\circ\text{C}$
	0.95	V	@ 12A
	0.65	V	@ 6A $T_J = 125^\circ\text{C}$
	0.78	V	@ 12A
I_{RM} Max. Reverse Leakage Current (Per Leg) * See Fig. 2 (1)	1	mA	$T_J = 25^\circ\text{C}$
	4	mA	$T_J = 125^\circ\text{C}$ $V_R = \text{rated } V_R$
$V_{F(TO)}$ Threshold Voltage	0.47	V	$T_J = T_{J,max}$
r_t Forward Slope Resistance	20.68	m Ω	
C_T Typ. Junction Capacitance (Per Leg)	183	pF	$V_R = 5V_{DC}$, (test signal range 100Khz to 1Mhz) 25°C
L_S Typical Series Inductance (Per Leg)	5.0	nH	Measured lead to lead 5mm from package body

(1) Pulse Width < 300 μs , Duty Cycle <2%

Thermal-Mechanical Specifications

Parameters	12CWQ...	Units	Conditions
T_J Max. Junction Temperature Range (*)	-55 to 150	$^\circ\text{C}$	
T_{stg} Max. Storage Temperature Range	-55 to 150	$^\circ\text{C}$	
R_{thJC} Max. Thermal Resistance (Per Leg) Junction to Case (Per Device)	3.0	$^\circ\text{C/W}$	DC operation * See Fig. 4
	1.5		
wt Approximate Weight	0.3 (0.01)	g (oz.)	
Case Style	D-Pak		Similar to TO-252AA
Marking Device	12CWQ10FN		

(*) $\frac{dP_{tot}}{dT_J} < \frac{1}{R_{th(j-a)}}$ thermal runaway condition for a diode on its own heatsink

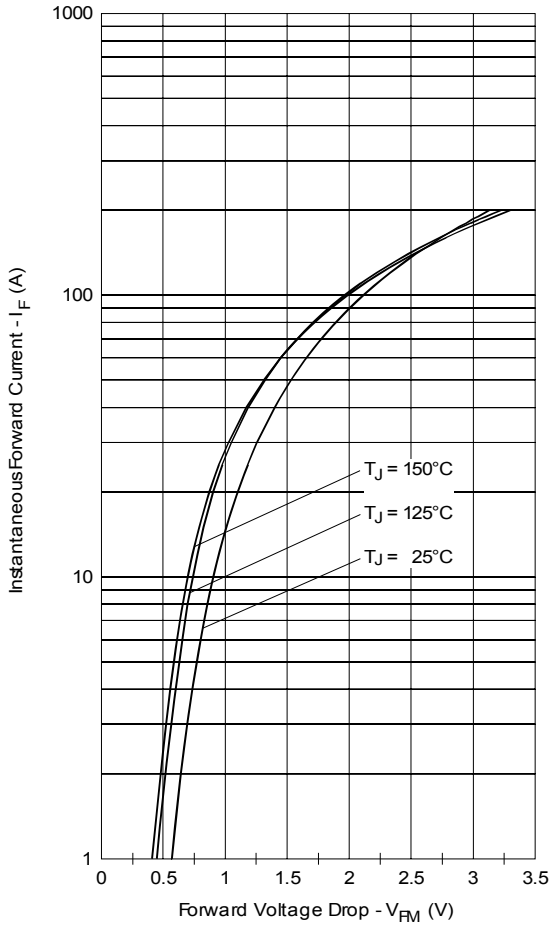

Fig. 1 - Max. Forward Voltage Drop Characteristics (Per Leg)

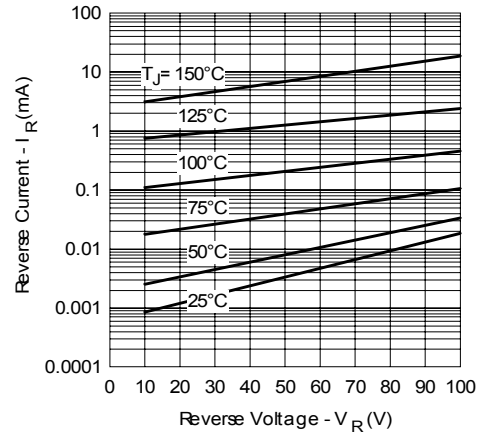

Fig. 2 - Typical Values Of Reverse Current Vs. Reverse Voltage (Per Leg)

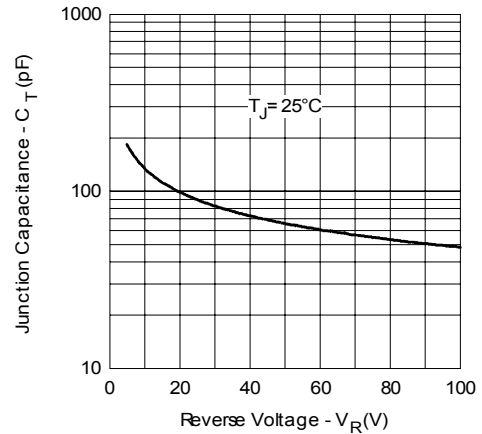

Fig. 3 - Typical Junction Capacitance Vs. Reverse Voltage (Per Leg)

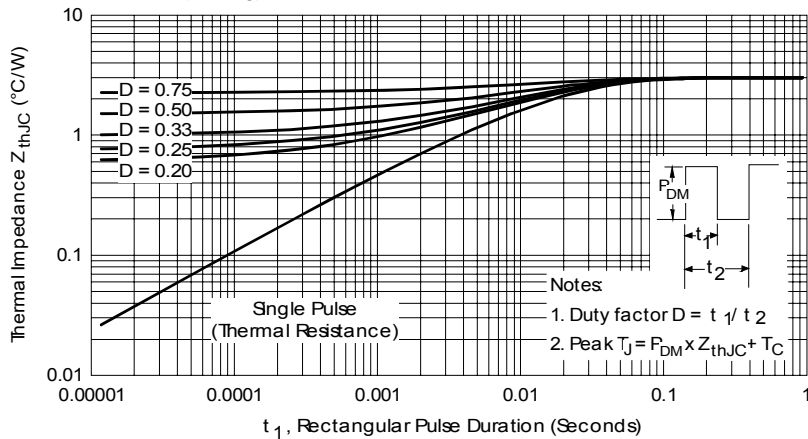

Fig. 4 - Max. Thermal Impedance Z_{thJC} Characteristics (Per Leg)

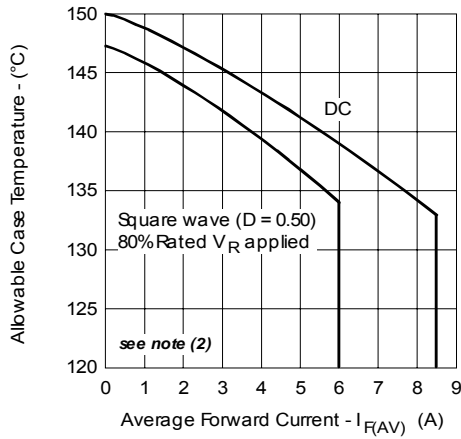

Fig. 5 - Max. Allowable Case Temperature Vs. Average Forward Current (Per Leg)

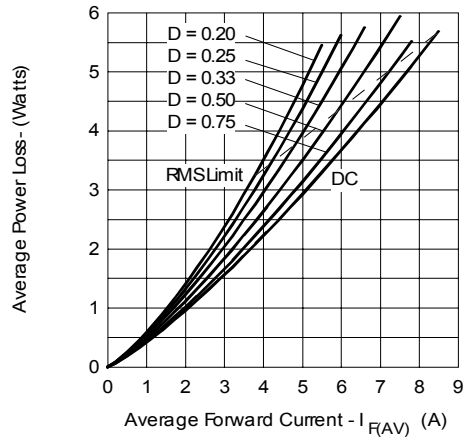

Fig. 6 - Forward Power Loss Characteristics (Per Leg)

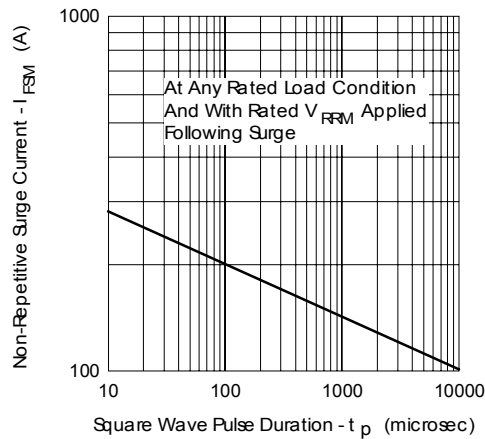

Fig. 7 - Max. Non-Repetitive Surge Current (Per Leg)

(2) Formula used: $T_c = T_j - (Pd + Pd_{REV}) \times R_{thJC}$;

Pd = Forward Power Loss = $I_{F(AV)} \times V_{FM} @ (I_{F(AV)} / D)$ (see Fig. 6);

Pd_{REV} = Inverse Power Loss = $V_{R1} \times I_R (1 - D)$; $I_R @ V_{R1} = 80\%$ rated V_R

Outline Table

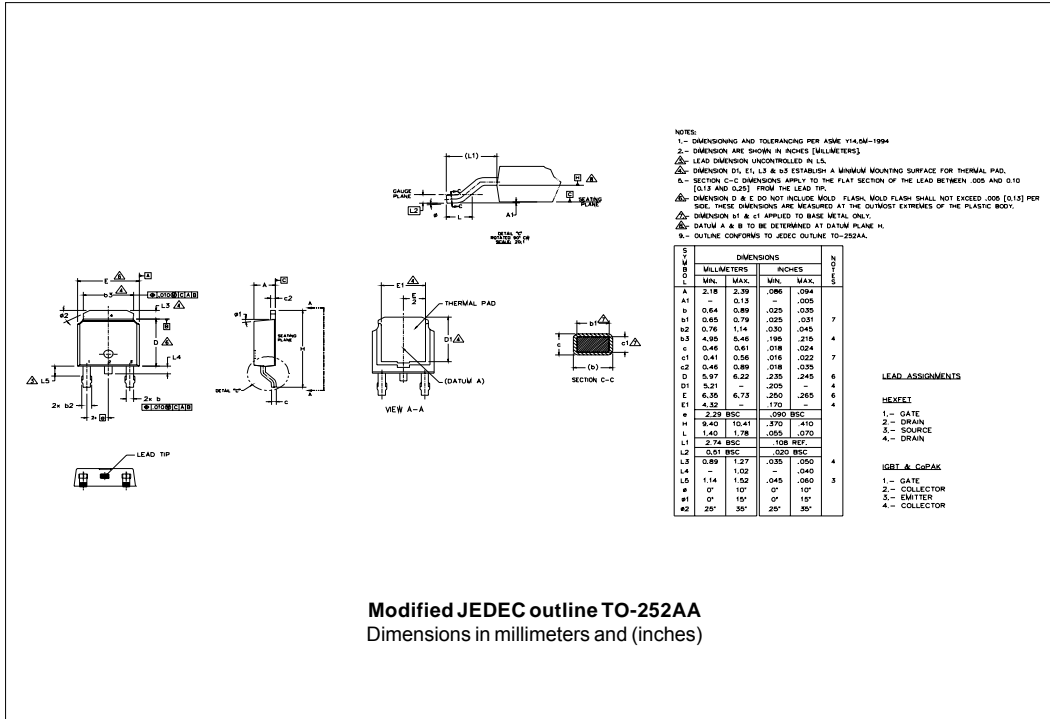

Modified JEDEC outline TO-252AA
Dimensions in millimeters and (inches)

Part Marking Information

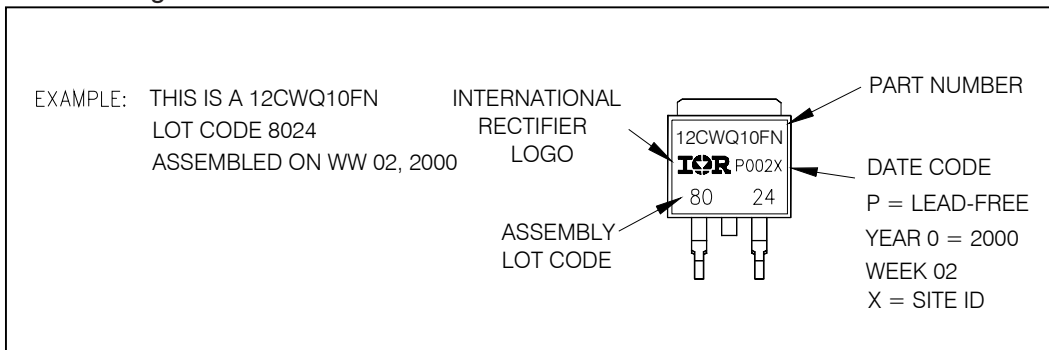

Tape & Reel Information

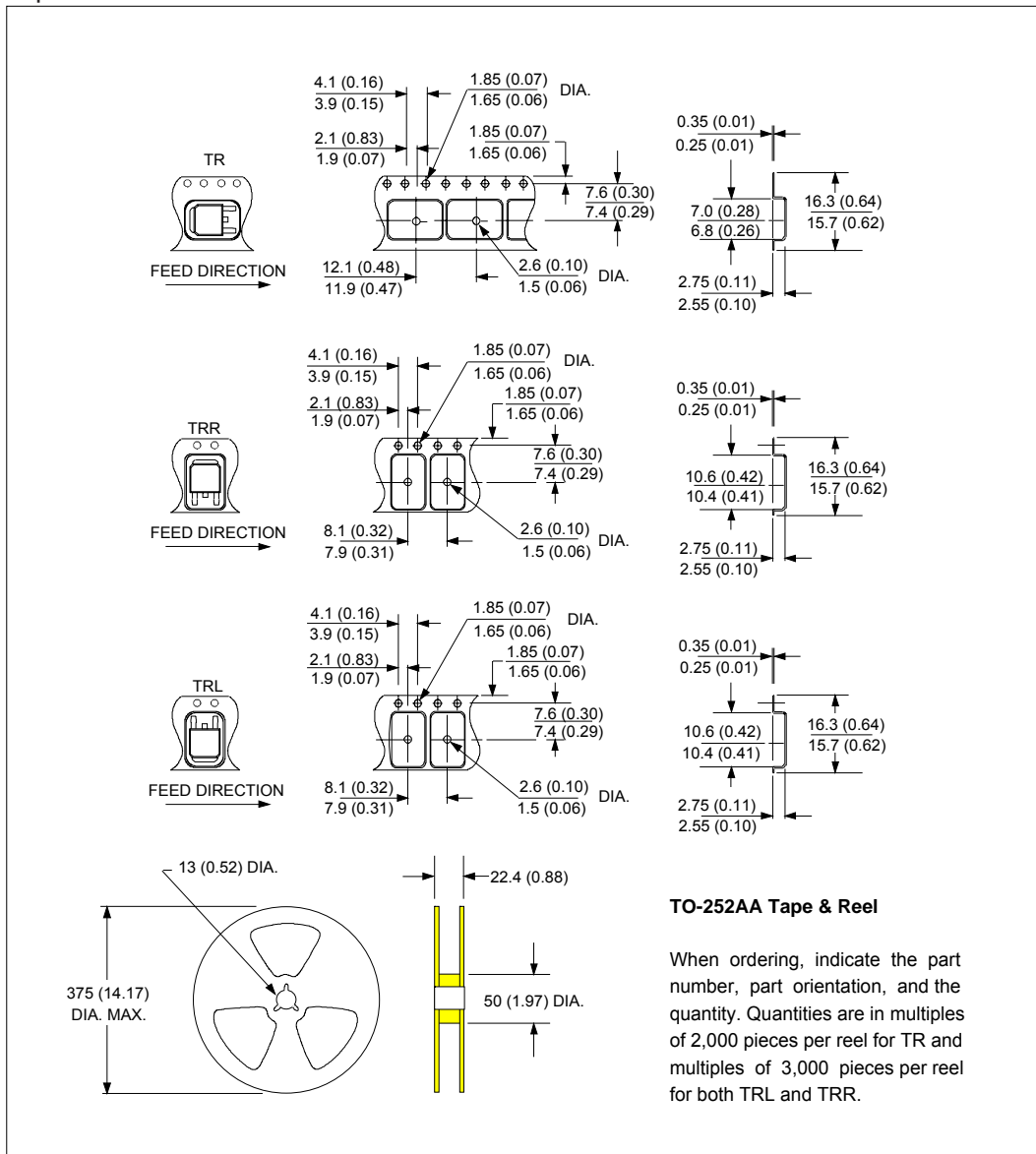

Ordering Information Table

Device Code	
12	C
W	Q
10	FN
TRL	PbF
(1)	(2)
(3)	(4)
(5)	(6)
(7)	(8)
1	- Current Rating (12A)
2	- Center Tap Configuration
3	- Package Identifier W = D-Pak
4	- Schottky "Q" Series
5	- Voltage Rating (10 = 100V)
6	- FN = TO-252AA
7	- <ul style="list-style-type: none"> • none = Tube (50 pieces) • TR = Tape & Reel • TRL = Tape & Reel (Left Oriented) • TRR = Tape & Reel (Right Oriented)
8	- <ul style="list-style-type: none"> • none = Standard Production • PbF = Lead-Free

Data and specifications subject to change without notice.
 This product has been designed and qualified for Consumer Level and Lead-Free.
 Qualification Standards can be found on IR's Web site.