

***Asymmetrical - Bridge  
MOSFET Power Module***

**$V_{DSS} = 100V$   
 $R_{DSon} = 4.5m\Omega$  typ @  $T_j = 25^\circ C$   
 $I_D = 278A$  @  $T_c = 25^\circ C$**

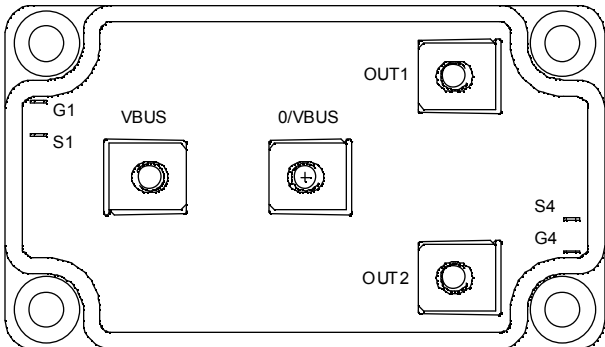
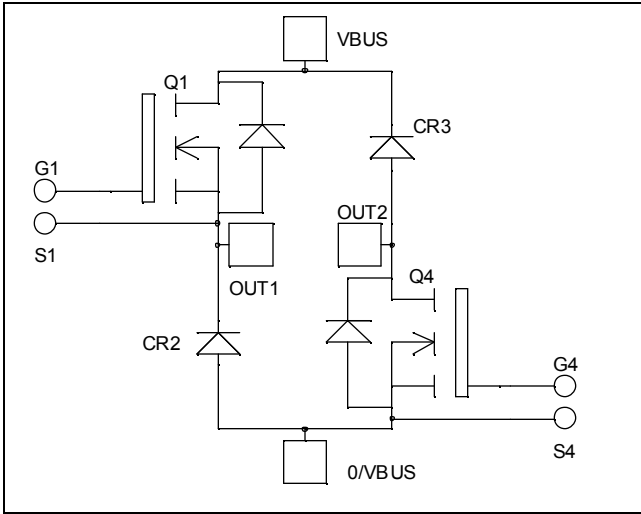

**Application**

- Welding converters
- Switched Mode Power Supplies
- Uninterruptible Power Supplies
- Motor control

**Features**

- Power MOS V<sup>®</sup> MOSFETs
  - Low  $R_{DSon}$
  - Low input and Miller capacitance
  - Low gate charge
  - Avalanche energy rated
  - Very rugged
- Kelvin source for easy drive
- Very low stray inductance
  - Symmetrical design
  - M5 power connectors
- High level of integration

**Benefits**

- Outstanding performance at high frequency operation
- Direct mounting to heatsink (isolated package)
- Low junction to case thermal resistance
- Low profile

**Absolute maximum ratings**

Symbol	Parameter	Max ratings	Unit
$V_{DSS}$	Drain - Source Breakdown Voltage	100	V
$I_D$	Continuous Drain Current	$T_c = 25^\circ C$	278
		$T_c = 80^\circ C$	207
$I_{DM}$	Pulsed Drain current	1100	
$V_{GS}$	Gate - Source Voltage	$\pm 30$	V
$R_{DSon}$	Drain - Source ON Resistance	5	$m\Omega$
$P_D$	Maximum Power Dissipation	$T_c = 25^\circ C$	780
$I_{AR}$	Avalanche current (repetitive and non repetitive)	100	A
$E_{AR}$	Repetitive Avalanche Energy	50	mJ
$E_{AS}$	Single Pulse Avalanche Energy	3000	

**CAUTION:** These Devices are sensitive to Electrostatic Discharge. Proper Handling Procedures Should Be Followed.

All ratings @  $T_j = 25^\circ\text{C}$  unless otherwise specified

## Electrical Characteristics

Symbol	Characteristic	Test Conditions	Min	Typ	Max	Unit
$I_{DSS}$	Zero Gate Voltage Drain Current	$V_{GS} = 0V, V_{DS} = 100V$			200	$\mu\text{A}$
		$V_{GS} = 0V, V_{DS} = 80V$			1000	
$R_{DS(on)}$	Drain – Source on Resistance	$V_{GS} = 10V, I_D = 125A$		4.5	5	$\text{m}\Omega$
$V_{GS(th)}$	Gate Threshold Voltage	$V_{GS} = V_{DS}, I_D = 5\text{mA}$	2		4	V
$I_{GSS}$	Gate – Source Leakage Current	$V_{GS} = \pm 30V, V_{DS} = 0V$			$\pm 200$	nA

## Dynamic Characteristics

Symbol	Characteristic	Test Conditions	Min	Typ	Max	Unit
$C_{iss}$	Input Capacitance	$V_{GS} = 0V$ $V_{DS} = 25V$ $f = 1\text{MHz}$		20		nF
$C_{oss}$	Output Capacitance			8		
$C_{rss}$	Reverse Transfer Capacitance			2.9		
$Q_g$	Total gate Charge	$V_{GS} = 10V$ $V_{Bus} = 50V$ $I_D = 250A$		700		nC
$Q_{gs}$	Gate – Source Charge			120		
$Q_{gd}$	Gate – Drain Charge			360		
$T_{d(on)}$	Turn-on Delay Time	<b>Resistive Switching</b> $V_{GS} = 15V$ $V_{Bus} = 66V$ $I_D = 250A$ $R_G = 2.5\Omega$		80		ns
$T_r$	Rise Time			165		
$T_{d(off)}$	Turn-off Delay Time			280		
$T_f$	Fall Time			135		
$E_{on}$	Turn-on Switching Energy ❶	<b>Inductive switching @ 25°C</b> $V_{GS} = 15V, V_{Bus} = 66V$ $I_D = 250A, R_G = 2.5\Omega$		1.1		mJ
$E_{off}$	Turn-off Switching Energy ❷			1.2		
$E_{on}$	Turn-on Switching Energy ❶	<b>Inductive switching @ 125°C</b> $V_{GS} = 15V, V_{Bus} = 66V$ $I_D = 250A, R_G = 2.5\Omega$		1.22		mJ
$E_{off}$	Turn-off Switching Energy ❷			1.28		

❶  $E_{on}$  includes diode reverse recovery.

❷ In accordance with JEDEC standard JESD24-1.

## Diode ratings and characteristics

Symbol	Characteristic	Test Conditions	Min	Typ	Max	Unit
$V_{RRM}$	Maximum Peak Repetitive Reverse Voltage		200			V
$I_{RM}$	Maximum Reverse Leakage Current	$V_R = 200V$	$T_j = 25^\circ\text{C}$		350	$\mu\text{A}$
			$T_j = 125^\circ\text{C}$		600	
$I_{F(AV)}$	Maximum Average Forward Current	50% duty cycle		200		A
$V_F$	Diode Forward Voltage	$I_F = 200A$		1		V
		$I_F = 400A$		1.4		
		$I_F = 200A$	$T_j = 125^\circ\text{C}$	0.9		
$t_{rr}$	Reverse Recovery Time	$I_F = 200A$ $V_R = 133V$ $di/dt = 600A/\mu\text{s}$	$T_j = 25^\circ\text{C}$		60	ns
			$T_j = 125^\circ\text{C}$		110	
$Q_{rr}$	Reverse Recovery Charge	$I_F = 200A$ $V_R = 133V$ $di/dt = 600A/\mu\text{s}$	$T_j = 25^\circ\text{C}$		400	nC
			$T_j = 125^\circ\text{C}$		1680	



**Typical Performance Curve**

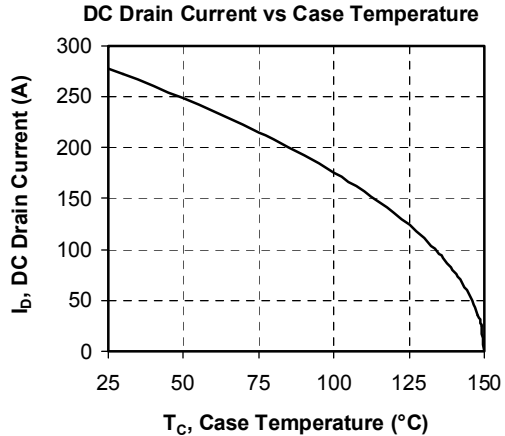
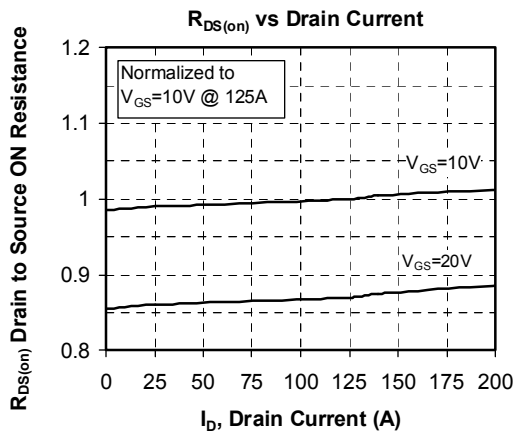
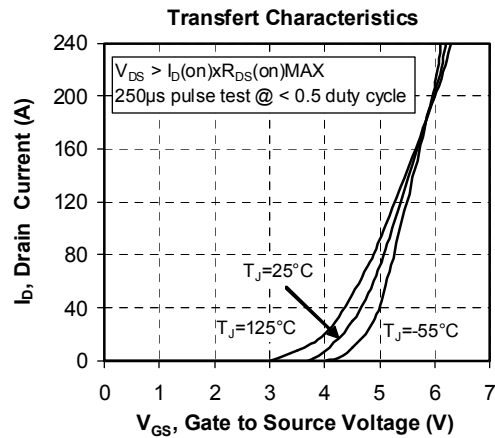
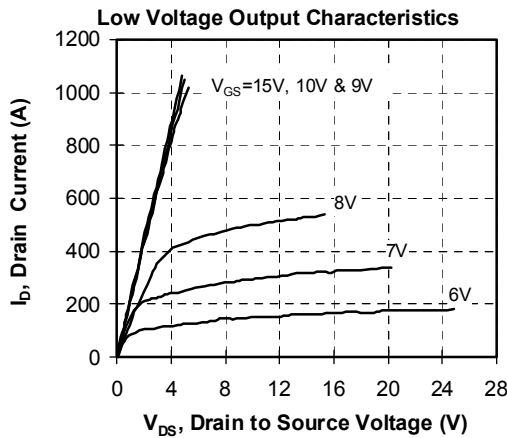
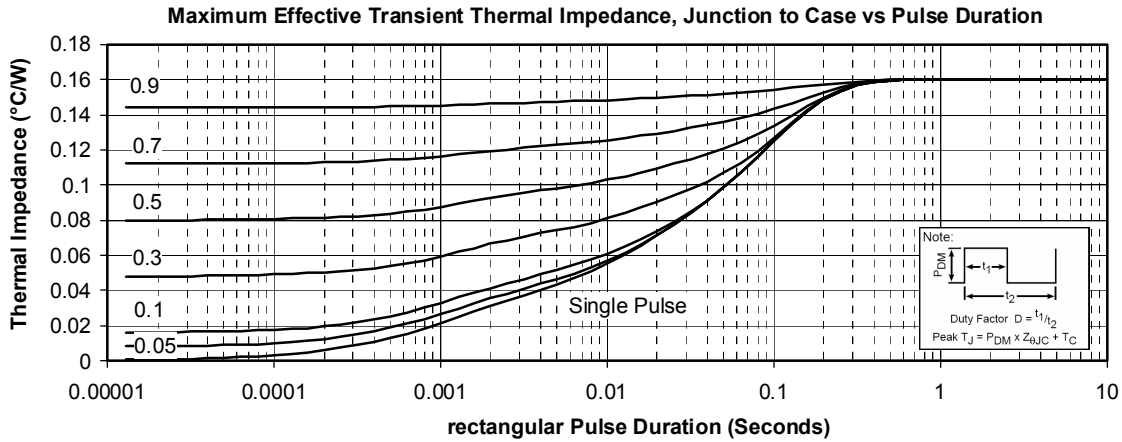

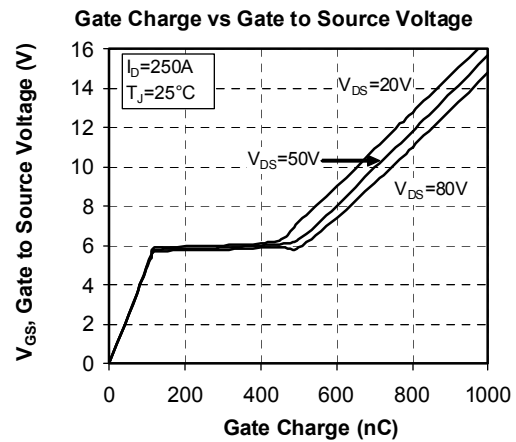
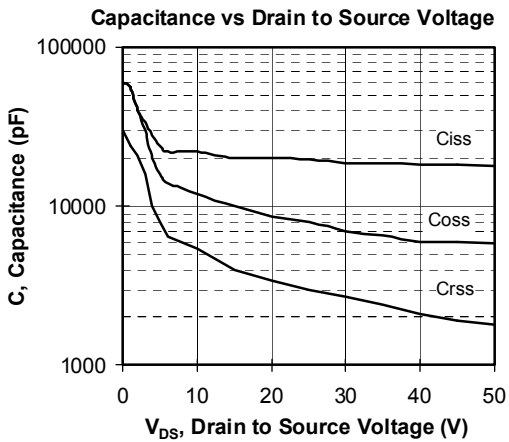
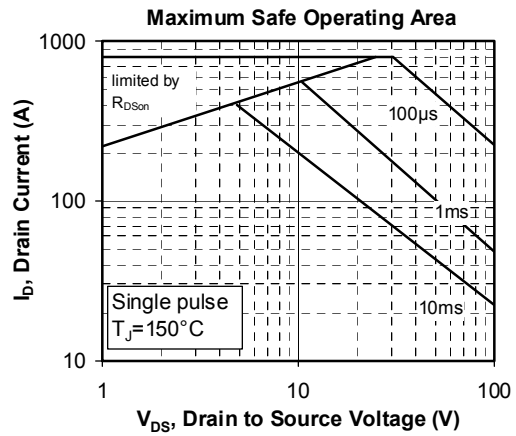
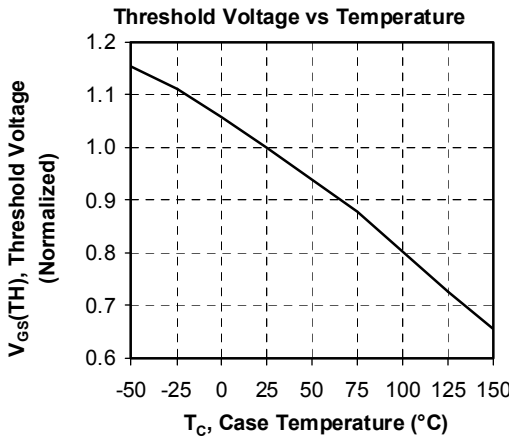
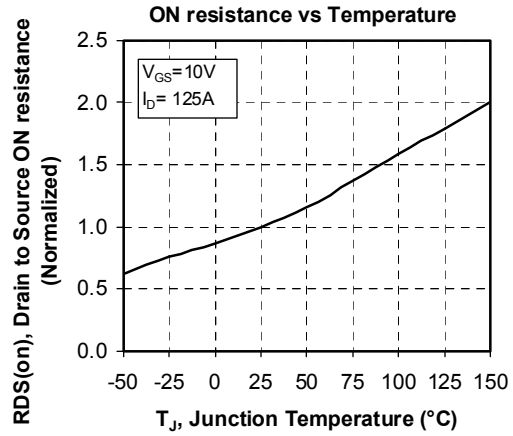

**Delay Times vs Current**

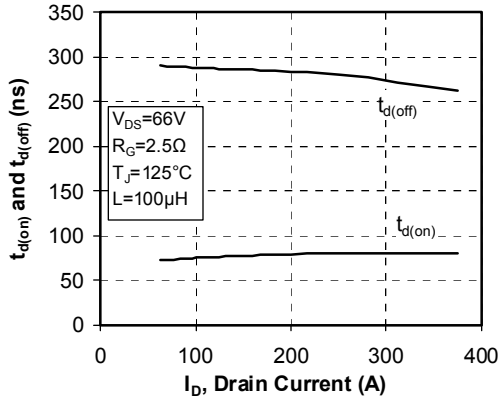

**Rise and Fall times vs Current**

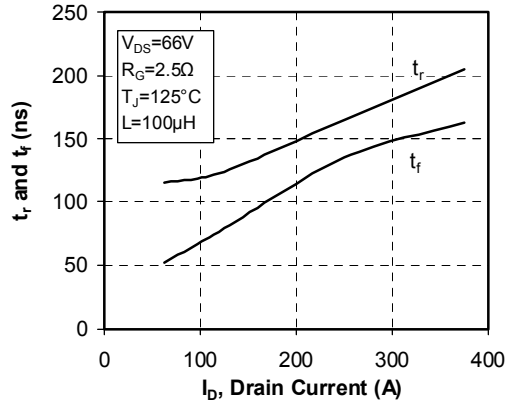

**Switching Energy vs Current**

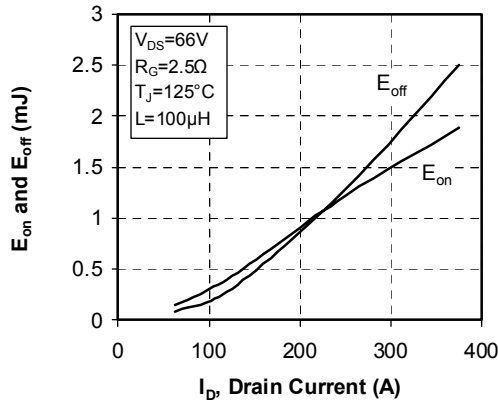

**Switching Energy vs Gate Resistance**

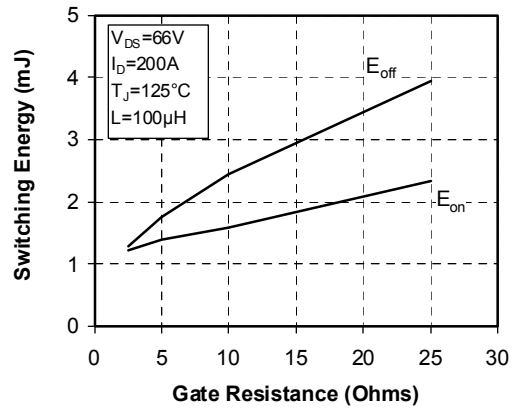

**Operating Frequency vs Drain Current**

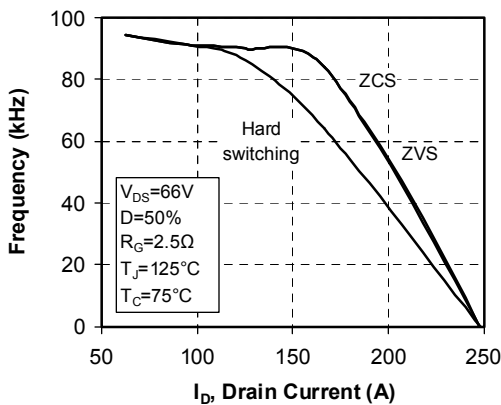

**Source to Drain Diode Forward Voltage**

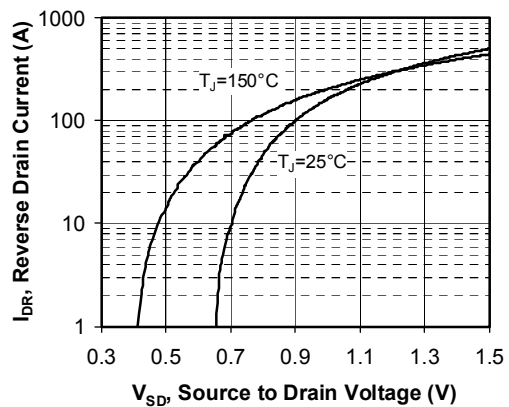

APT reserves the right to change, without notice, the specifications and information contained herein

APT's products are covered by one or more of U.S. patents 4,895,810 5,045,903 5,089,434 5,182,234 5,019,522 5,262,336 6,503,786 5,256,583 4,748,103 5,283,202 5,231,474 5,434,095 5,528,058 and foreign patents. U.S. and Foreign patents pending. All Rights Reserved.