

## *Mono 1.9W / Stereo 300mW Power Amplifier* *Low Voltage Operation, Pop Noise Free*

### FEATURES

- Operation range: 2.7V~5.5V
- Shutdown Current 18uA at 5V
- Output power, THD+N=1%  
BTL,  $R_L=3\Omega$ , 2.1W at 5V  
BTL,  $R_L=4\Omega$ , 1.9W at 5V, 0.83W at 3.3V, 500mW at 2.7V  
BTL,  $R_L=8\Omega$ , 1.2W at 5V, 0.54W at 3.3V, 350mW at 2.7V  
SE,  $R_L=8\Omega$ , 300mW at 5V, 125mW at 3.3V, 85mW at 2.7V  
SE,  $R_L=32\Omega$ , 90mW at 5V, 43mW at 3.3V, 25mW at 2.7V
- Headphone sense
- Unity-gain stable, pop noise free
- Space-saving MSOP10 (enhance thermal pad), TSSOP14

### APPLICATIONS

- Desktop computer's sound card
- Portable audio devices
- PDA's
- Handheld games
- Communication headsets
- Cross-reference:  
SSM2250, LM4853

### DESCRIPTION

The MS6853 is a low distortion power amplifier that can drive a set of 1.9W of continuous average power into a mono 4Ω bridged-tied load (BTL) or 2 \* 90mW into stereo 32Ω single ended (SE) loads headphone. It can automatically switch between mono BTL and stereo SE modes utilizing a headphone sense pin. The BTL configuration eliminates the need for external coupling capacitors on the output in most applications. The unity gain stable MS6853's gain is set by external gain-setting resistors.

The MS6853 has good feature for portable equipment, these features include the low voltage operation, micropower consumption shutdown mode, enhance thermal pad and small package MSOP10, TSSOP14, make the MS6853 ideally suited for use in portable digital audio equipments.

### BLOCK DIAGRAM

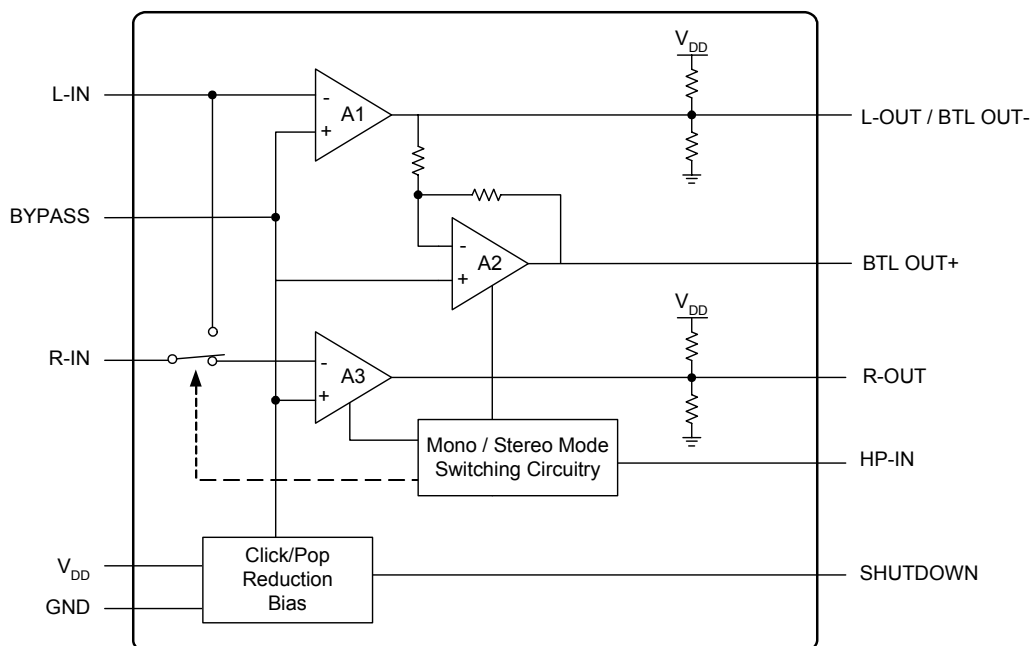

## PIN CONFIGURATION

Symbol	MSOP10 Pin	TSSOP14 Pin	Description
L-IN	1	2	Left channel input
SHUTDOWN	2	3	SHUTDOWN places the entire device in shutdown mode when held high. TTL compatible input.
HP-IN	3	4	Headphone input detection. A logical low sets BTL mode, a logical high sets SE mode.
GND	4	5	Ground
R-IN	5	6	Right channel input
R-OUT	6	9	Right channel output
BY PASS	7	10	BYPASS is the cap to the voltage divider for internal mid-supply bias. This terminal should be connected to a 0.1- $\mu$ F to 10- $\mu$ F capacitor C <sub>BP</sub> .
BTL OUT+	8	11	Bridged-tied load positive output
VDD	9	12	Supply voltage
L-OUT/BTL OUT-	10	13	Left channel output or bridged-tied load negative output
nc	-	1,7,8,14	No connected

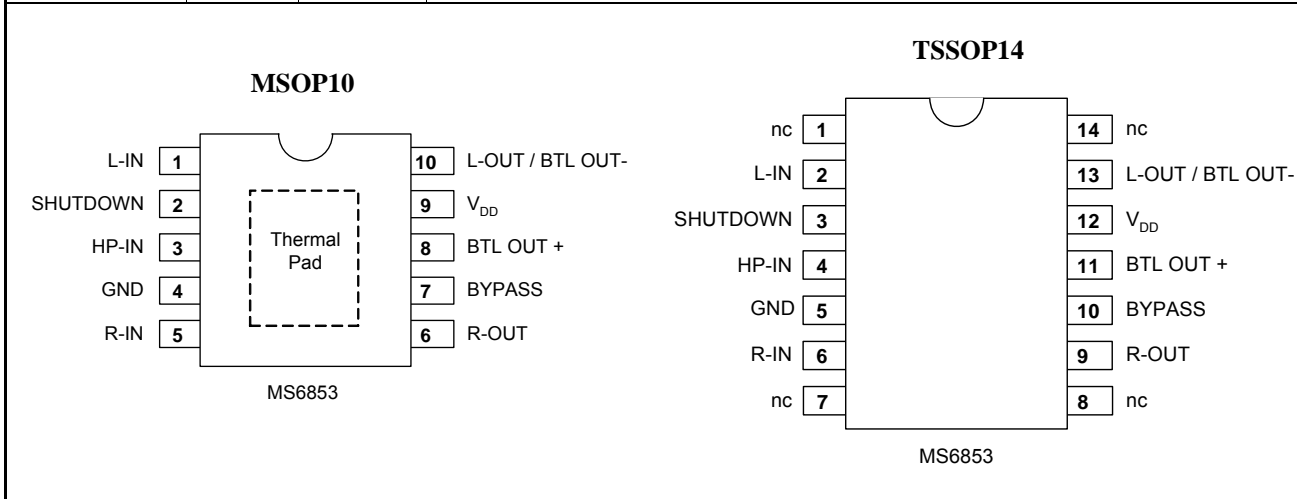

## ORDERING INFORMATION

Package	Part number	Packaging Marking	Transport Media
10-Pin MSOP	MS6853MTR	6853	3.5k Units Tape and Reel
10-Pin MSOP	MS6853MU	6853	80 Units Tube
10-Pin MSOP (lead free)	MS6853MGTR	6853G	3.5k Units Tape and Reel
10-Pin MSOP (lead free)	MS6853MGU	6853G	80 Units Tube
14Pin TSSOP	MS6853TTR	MS6853	2.5Units Tape and Reel
14Pin TSSOP	MS6853TU	MS6853	98Units Tube
14Pin TSSOP (lead free)	MS6853TGTR	MS6853G	2.5Units Tape and Reel
14Pin TSSOP (lead free)	MS6853TGU	MS6853G	98Units Tube

## ABSOLUTE MAXIMUM RATINGS

Symbol	Parameter	Rating	Unit
V <sub>DD</sub>	Supply voltage	6	V
V <sub>ESD</sub>	Electrostatic handling	3500	V
T <sub>STG</sub>	Storage temperature range	-65 to 150	°C
T <sub>A</sub>	Operating ambient temperature range	-40 to 85	°C
T <sub>J</sub>	Maximum junction temperature	150	°C
T <sub>S</sub>	Soldering temperature, 10 seconds	260	°C
R <sub>THJA</sub>	Thermal resistance from junction to ambient in free air MSOP10 (enhance thermal pad) TSSOP14	50 150	°C/W

## OPERATING RATINGS

Symbol	Parameter	Min	Typ	Max	Unit
V <sub>DD</sub>	Supply voltage	2.7	5	5.5	V

## 5V ELECTRICAL CHARACTERISTICS

T<sub>a</sub> = 25°C, V<sub>DD</sub> = 5V, f = 1kHz, BW < 30kHz, unless otherwise specified.

Symbol	Parameter	Conditions	Min	Typ	Max	Unit
I <sub>Q</sub>	Quiescent current	BTL Mode, V <sub>IN</sub> = 0V, I <sub>O</sub> = 0A	-	2.4	-	mA
		SE Mode, V <sub>IN</sub> = 0V, I <sub>O</sub> = 0A	-	1.6	-	mA
I <sub>SD</sub>	Shutdown current	SD Mode, V <sub>SD</sub> = V <sub>DD</sub>		18		µA
V <sub>SDH</sub>	Shutdown input voltage high		2.0	-	-	V
V <sub>SDL</sub>	Shutdown input voltage low		-	-	0.8	V
CS	Channel separation	SE Mode, R <sub>L</sub> = 32Ω	100	110	-	dB
PSRR	Power supply rejection ratio	BTL Mode, R <sub>L</sub> = 8Ω C <sub>BP</sub> = 1µF, f = 100Hz	-	73	-	dB
		SE Mode, R <sub>L</sub> = 32Ω C <sub>BP</sub> = 10µF, f = 100Hz	-	64	-	dB
THD+N	Total harmonic distortion plus noise	SE mode, R <sub>L</sub> = 32Ω, 60mW	-	-73	-68	dB
			-	0.022	0.04	%
S/N	Signal-to-noise ratio	SE mode, A-weighting	90	95	-	dB
P <sub>o</sub>	Output power	BTL Mode, R <sub>L</sub> = 3Ω THD+N = 1%	-	2.1	-	W
		BTL Mode, R <sub>L</sub> = 4Ω THD+N = 1%	-	1.9	-	W
		BTL Mode, R <sub>L</sub> = 8Ω THD+N = 1%	-	1.2	-	W
		SE Mode, R <sub>L</sub> = 8Ω THD+N = 1%	-	300m	-	W
		SE Mode, R <sub>L</sub> = 32Ω THD+N = 1%	-	90m	-	W

## 3.3 V ELECTRICAL CHARACTERISTICS

T<sub>a</sub> = 25°C, V<sub>DD</sub>=3.3V, f=1kHz, BW<30kHz, unless otherwise specified.

Symbol	Parameter	Conditions	Min	Typ	Max	Unit
I <sub>Q</sub>	Quiescent current	BTL Mode, V <sub>IN</sub> =0V, I <sub>O</sub> =0A	-	2.1	-	mA
		SE Mode, V <sub>IN</sub> =0V, I <sub>O</sub> =0A	-	1.5	-	mA
I <sub>SD</sub>	Shutdown current	SD Mode, V <sub>SD</sub> =V <sub>DD</sub>	-	12	-	uA
CS	Channel separation	SE Mode, R <sub>L</sub> =32Ω	100	110	-	dB
PSRR	Power supply rejection ratio	BTL Mode, R <sub>L</sub> =8Ω C <sub>BP</sub> =1uF, f=100Hz	-	73	-	dB
		SE Mode, R <sub>L</sub> =32Ω C <sub>BP</sub> =10uF, f=100Hz	-	67	-	dB
THD+N	Total harmonic distortion plus noise	SE mode, R <sub>L</sub> =32Ω, 25mW	-	-70	-65	dB
			0.032	0.056	%	
S/N	Signal-to-noise ratio	SE mode, A-weighting	89	94	-	dB
P <sub>o</sub>	Output power	BTL Mode, R <sub>L</sub> = 4Ω THD+N = 1%	-	0.83	-	W
		BTL Mode, R <sub>L</sub> = 8Ω THD+N = 1%	-	0.54	-	W
		SE Mode, R <sub>L</sub> = 8Ω THD+N = 1%	-	125m	-	W
		SE Mode, R <sub>L</sub> = 32Ω THD+N = 1%	-	43m	-	W

## 2.7 V ELECTRICAL CHARACTERISTICS

T<sub>a</sub> = 25°C, V<sub>DD</sub>=2.7V, f=1kHz, BW<30kHz, unless otherwise specified.

Symbol	Parameter	Conditions	Min	Typ	Max	Unit
I <sub>Q</sub>	Quiescent current	BTL Mode, V <sub>IN</sub> =0V, I <sub>O</sub> =0A	-	2	-	mA
		SE Mode, V <sub>IN</sub> =0V, I <sub>O</sub> =0A	-	1.4	-	mA
I <sub>SD</sub>	Shutdown current	SD Mode, V <sub>SD</sub> =V <sub>DD</sub>	-	7.5	-	uA
CS	Channel separation	SE Mode, R <sub>L</sub> =32Ω	100	110	-	dB
PSRR	Power supply rejection ratio	BTL Mode, R <sub>L</sub> =8Ω C <sub>BP</sub> =1uF, f=100Hz	-	73	-	dB
		SE Mode, R <sub>L</sub> =32Ω C <sub>BP</sub> =10uF, f=100Hz	-	67	-	dB
THD+N	Total harmonic distortion plus noise	SE mode, R <sub>L</sub> =32Ω, 15mW	-	-69	-64	dB
			0.036	0.063	%	
S/N	Signal-to-noise ratio	SE mode, A-weighting	87	92	-	dB
P <sub>o</sub>	Output power	BTL Mode, R <sub>L</sub> = 4Ω THD+N = 1%	-	0.51	-	W
		BTL Mode; R <sub>L</sub> = 8Ω THD+N = 1%	-	0.35	-	W
		SE Mode; R <sub>L</sub> = 8Ω THD+N = 1%	-	85m	-	W
		SE Mode; R <sub>L</sub> = 32Ω THD+N = 1%	-	25m	-	W

## TYPICAL PERFORMANCE CHARACTERISTICS

Ta = 25°C, BW < 30kHz, unless otherwise specified.

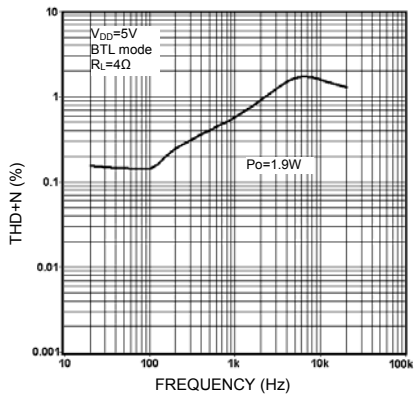

THD+N vs. frequency

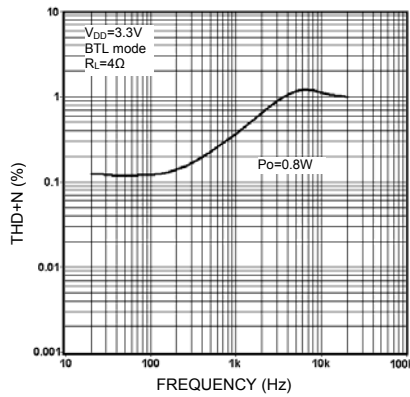

THD+N vs. frequency

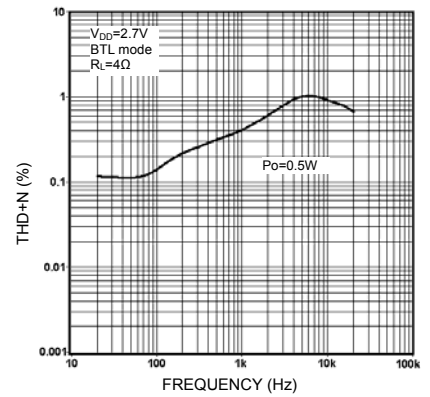

THD+N vs. frequency

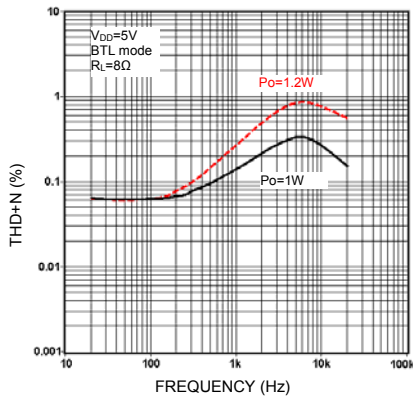

THD+N vs. frequency

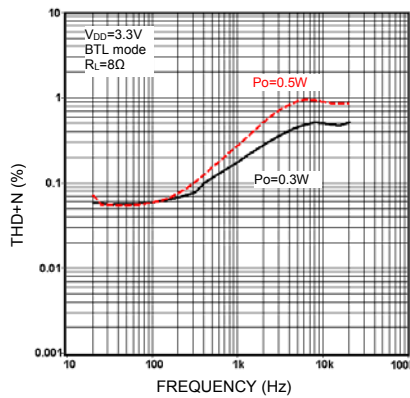

THD+N vs. frequency

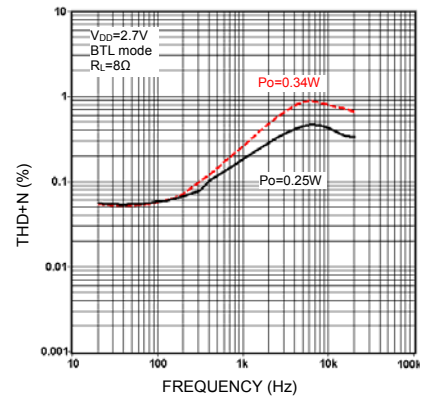

THD+N vs. frequency

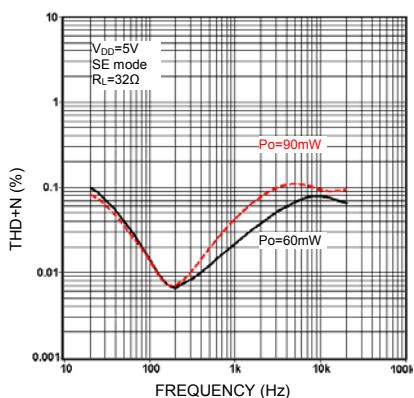

THD+N vs. frequency

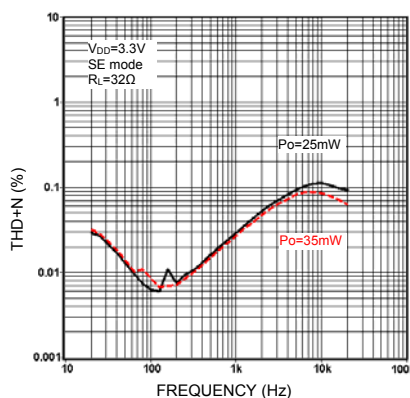

THD+N vs. frequency

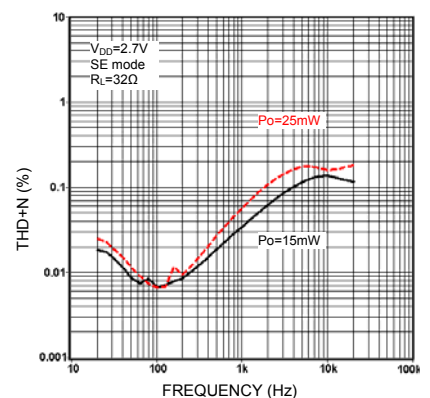

THD+N vs. frequency

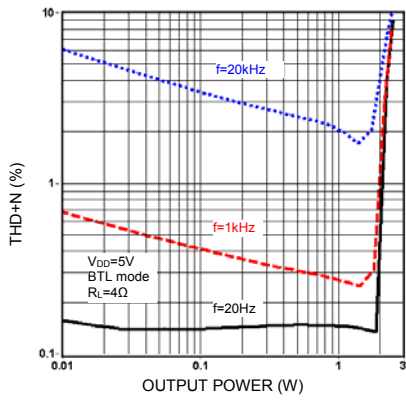

THD+N vs. output power

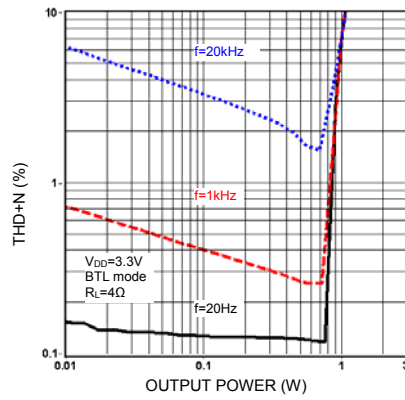

THD+N vs. output power

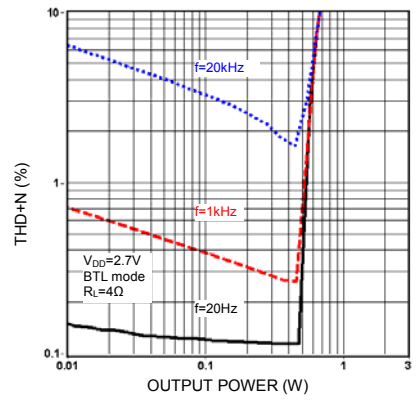

THD+N vs. output power

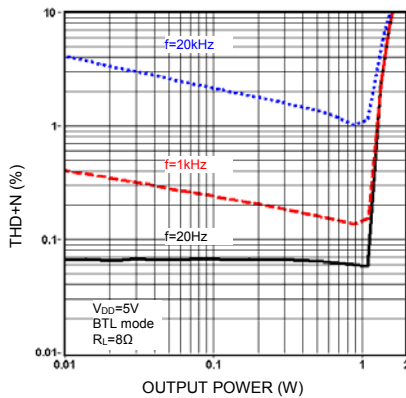

THD+N vs. output power

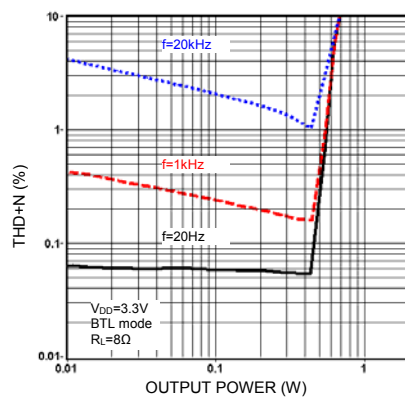

THD+N vs. output power

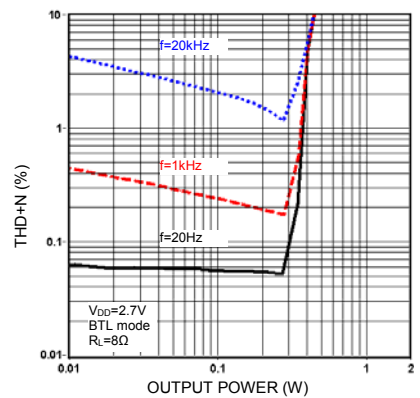

THD+N vs. output power

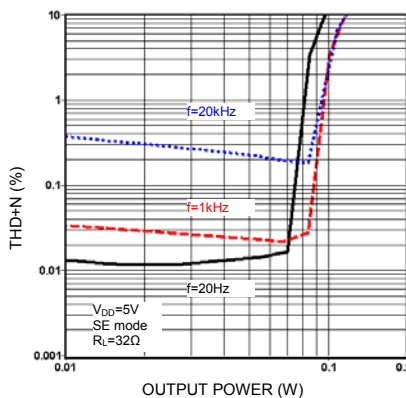

THD+N vs. output power

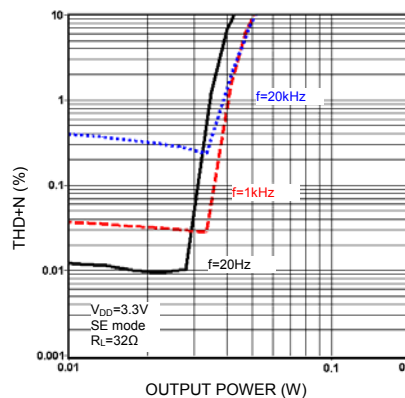

THD+N vs. output power

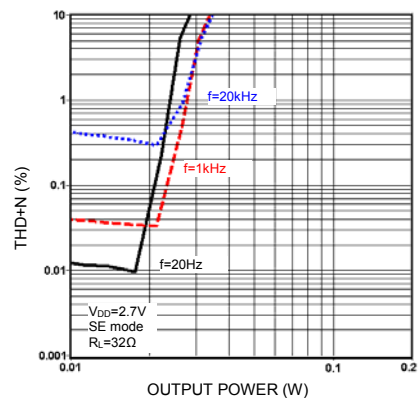

THD+N vs. output power

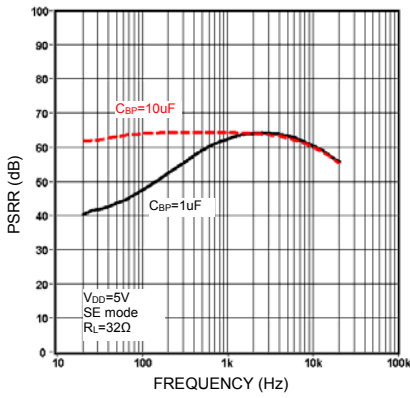

PSRR vs. frequency

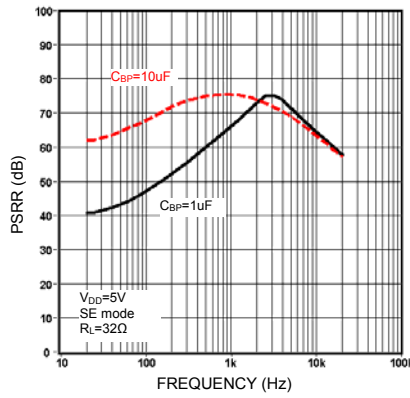

PSRR vs. frequency

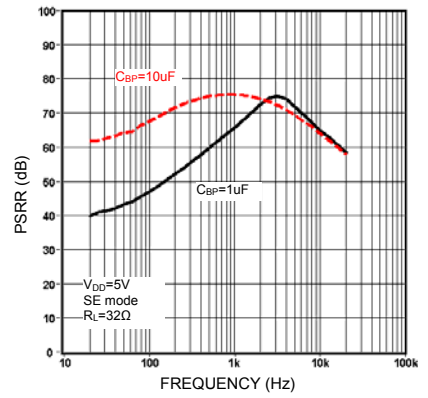

PSRR vs. frequency

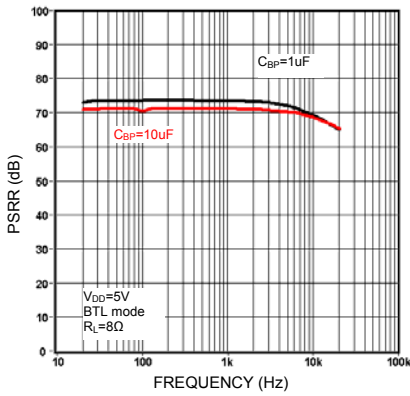

PSRR vs. frequency

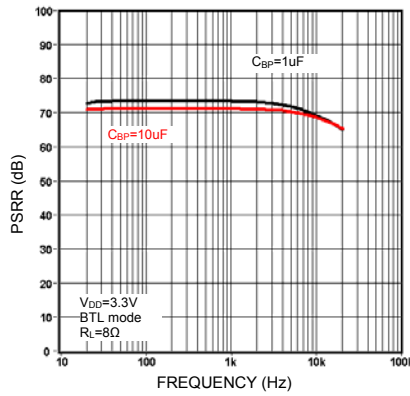

PSRR vs. frequency

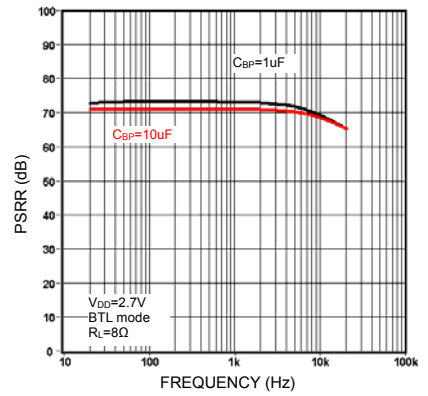

PSRR vs. frequency

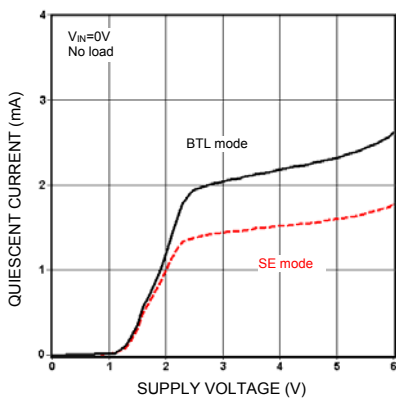

Quiescent current vs. supply voltage

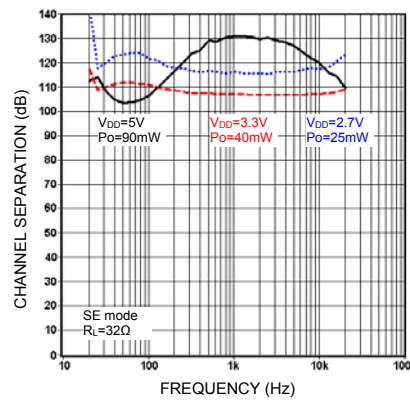

Channel separation vs. frequency

## APPLICATION INFORMATION

### Basic application example

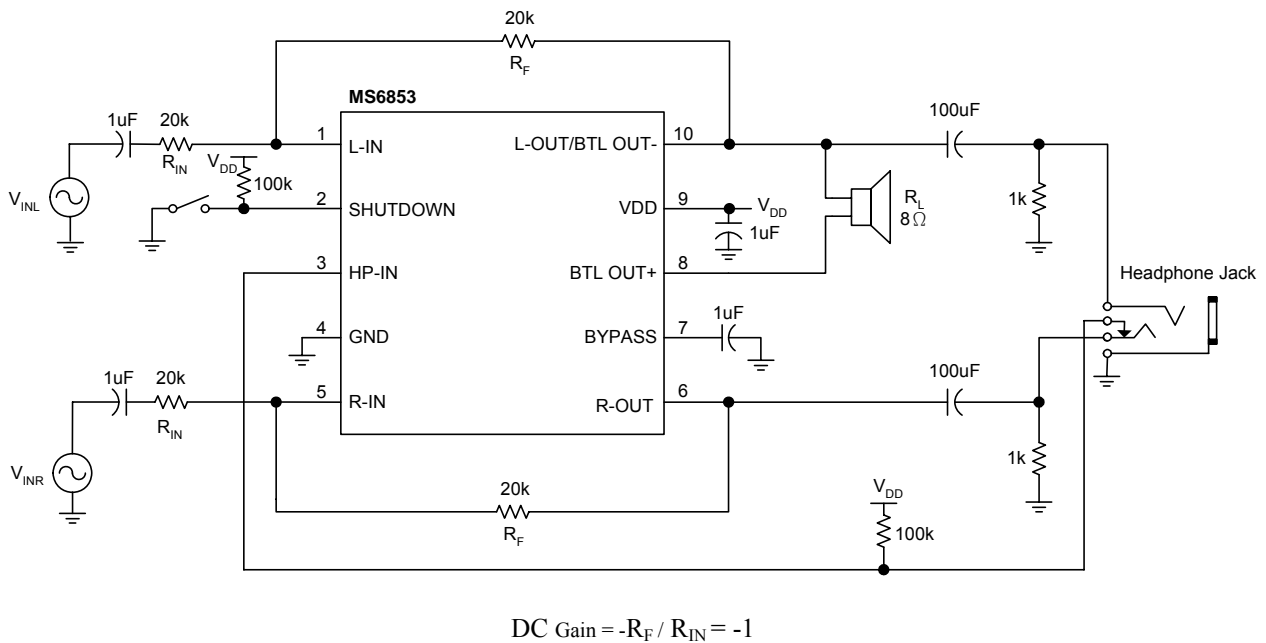

**Fig.1 A audio amplifier application circuit.**

### SE mode and BTL mode operation

As shown in block diagram and Fig.1, in the SE mode, the MS6853 operates as a high current output dual op amp. Amplifier A1 and A3 are independent amplifiers with an externally configured gain of  $A_V = -R_F/R_{IN}$ . Amplifier A2 is shut down to a high output impedance state.

In BTL mode, A3 is shutdown to a high impedance state. The audio signal from the R-IN pin is directed to the inverting input of A1. As a result, the L-IN and R-IN audio signals,  $V_{INL}$  and  $V_{INR}$ , are summed together at the input of A1. A2 is then activated with a closed-loop gain of  $A_V = -1$  fixed by two internal resistors. The outputs of A1 and A2 are then used to drive the mono bridged-tied load.

### HP-IN operation

The ability of the MS6853 is easily switched between mono BTL and stereo SE modes. The mode is switched by headphone control pin, HP-IN. A logic-high activates the SE mode when a set of headphones plugged into the system, on the other hand, a logical-low to HP-IN activates the BTL mode when no headphones.

### Thermal pad considerations

The thermal pad must be connected to ground. The package with thermal pad of the MS6853 requires special attention on thermal design. The thermal pad on the bottom of the MS6853 should be soldered down to a copper pad on the circuit board. Heat can be conducted away from the thermal pad through the copper plane to ambient. If the copper plane is not on the top surface of the circuit board, 9 vias of 13 mil or smaller in diameter should be used to thermally couple the thermal pad to the bottom plane. For good thermal conduction, the vias must be plated through and solder filled.



## EXTERNAL DIMENSIONS

### MSOP10 (Thermal Pad)

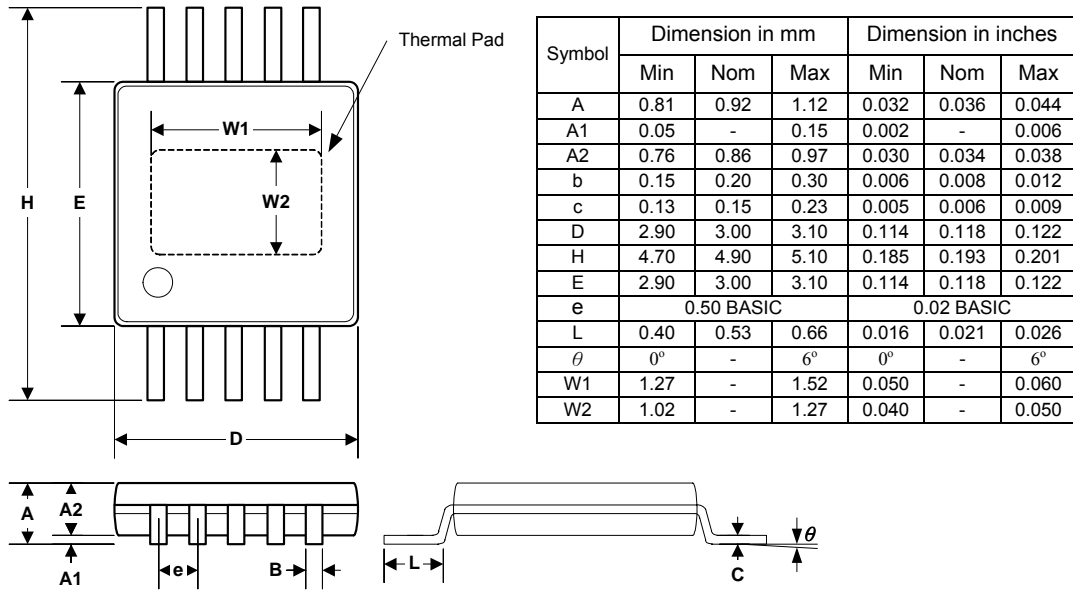

### TSSOP14

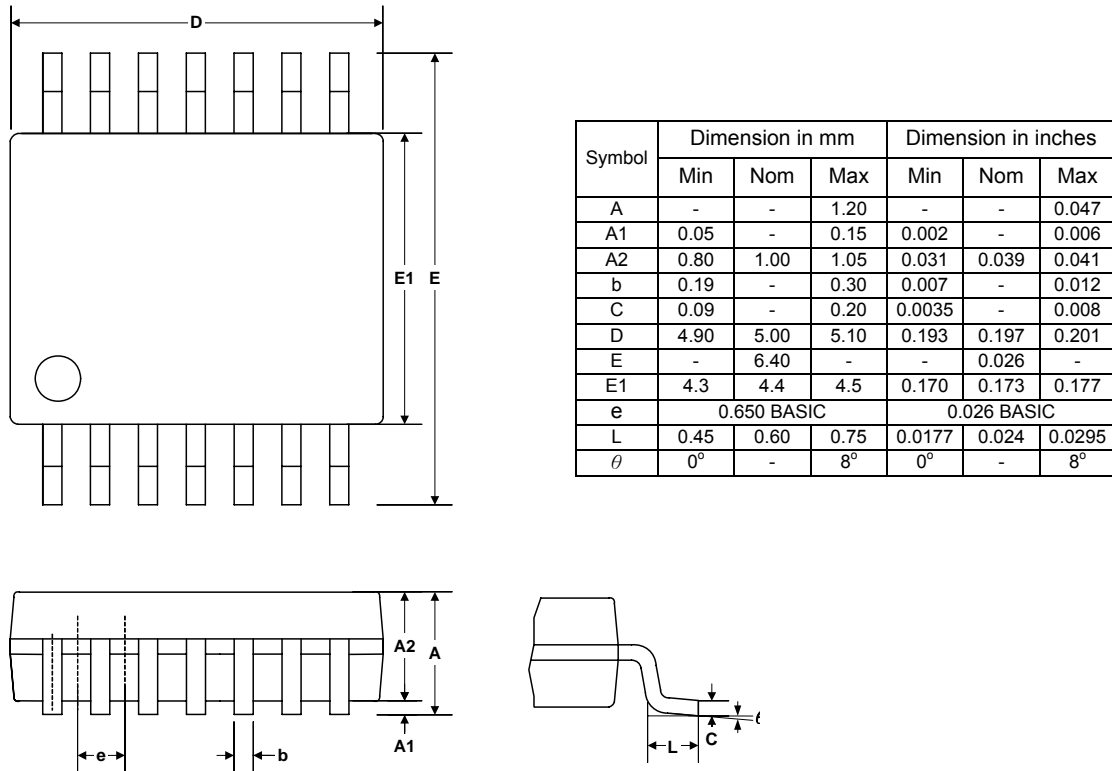

## TAPE AND REEL (Unit : mm)

### MSOP10

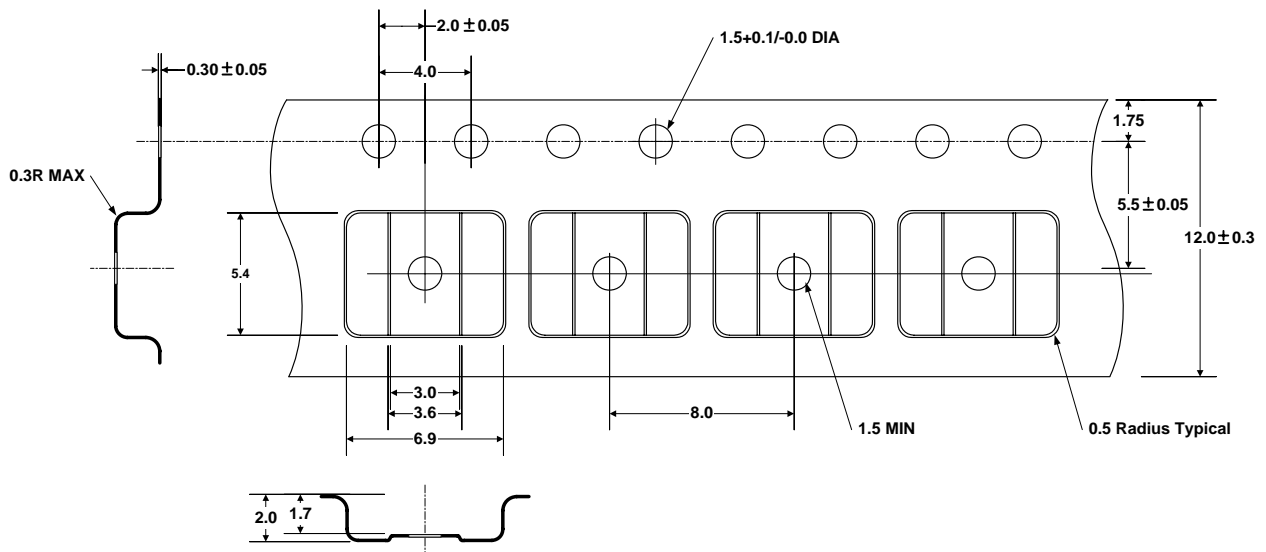

## DEMO BOARD

### MSOP10 (Thermal Pad)

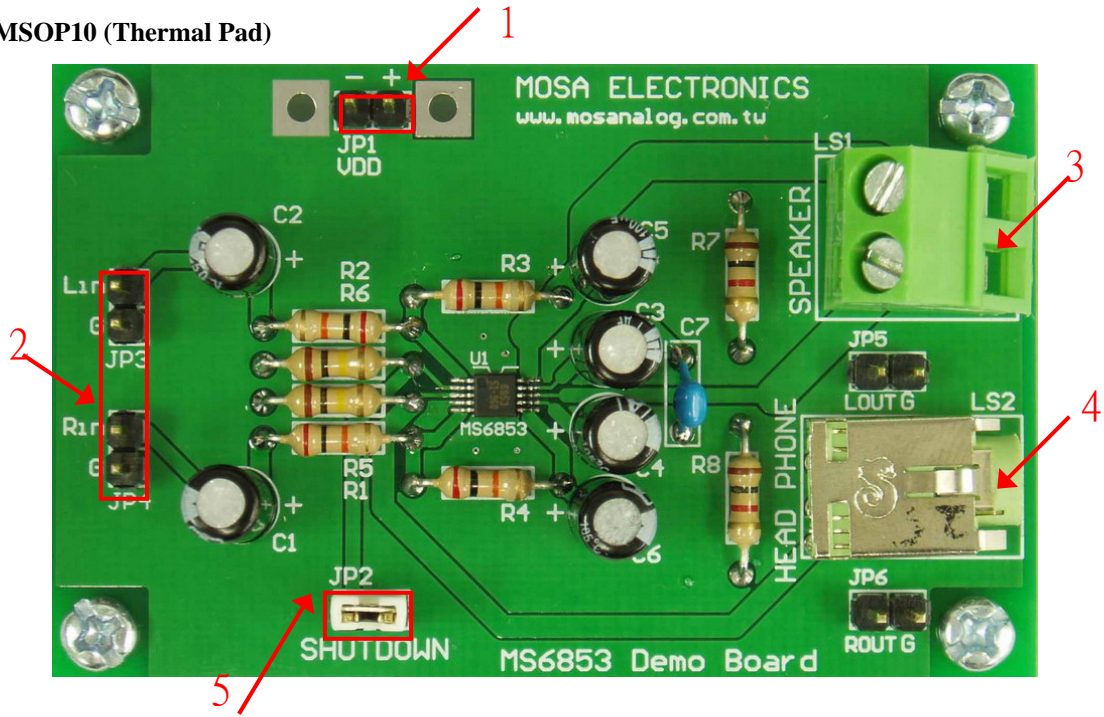

### TSSOP14

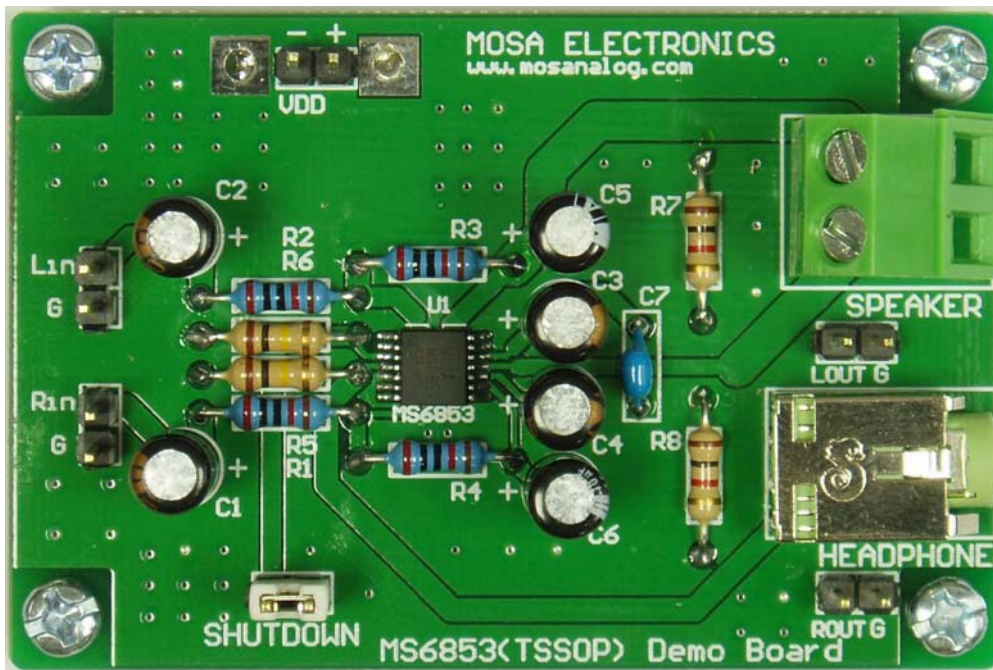

### **Function description**

#### Label 1: Supply Input

Supply voltage range is 2.7V to 5.5V, the right of jump is positive, the left of jump is negative.

#### Label 2: Signal Input

Connected to audio signals.

#### Label 3: Speaker Output

Connected to speaker with 8ohm or 4 ohm

#### Label 4: Headphone Jack

Used 3.5mm diameter of headphone with 32ohm

#### Label 5: Shutdown Control

System is active mode when jump is close, system enters shutdown mode when jump is open.

### **SE mode and BTL mode operation**

The headphone controls operational mode. System enters SE mode when headphone jack is empty. When a set of headphone plugged into the jack, the system switched to BTL mode.