



## N-Channel Enhancement Mode Field Effect Transistor

### PRODUCT SUMMARY

V <sub>DSS</sub>	I <sub>D</sub>	R <sub>DS(ON)</sub> (mΩ) Max
30V	24A	32 @ V <sub>GS</sub> = 10V
		57 @ V <sub>GS</sub> = 4.5V

### FEATURES

- Super high dense cell design for low R<sub>DS(ON)</sub>.
- Rugged and reliable.
- TO-252 and TO-251 Package.

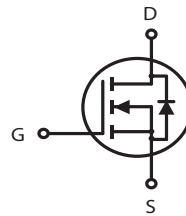

### ABSOLUTE MAXIMUM RATINGS (T<sub>A</sub>=25°C unless otherwise noted)

Parameter	Symbol	Limit	Unit
Drain-Source Voltage	V <sub>DS</sub>	30	V
Gate-Source Voltage	V <sub>GS</sub>	± 20	V
Drain Current-Continuous @ T <sub>J</sub> =125°C -Pulsed <sup>a</sup>	I <sub>D</sub>	24	A
	I <sub>DM</sub>	60	A
Drain-Source Diode Forward Current	I <sub>S</sub>	20	A
Maximum Power Dissipation @ T <sub>C</sub> =25°C	P <sub>D</sub>	50	W
Operating and Storage Temperature Range	T <sub>J</sub> , T <sub>STG</sub>	-55 to 175	°C

### THERMAL CHARACTERISTICS

Thermal Resistance, Junction-to-Case	R <sub>θJC</sub>	3	°C/W
Thermal Resistance, Junction-to-Ambient	R <sub>θJA</sub>	50	°C/W

# STU/D9410

ELECTRICAL CHARACTERISTICS (TA=25 °C unless otherwise noted)

Parameter	Symbol	Condition	Min	Typ <sup>c</sup>	Max	Unit
<b>OFF CHARACTERISTICS</b>						
Drain-Source Breakdown Voltage	BV <sub>DSS</sub>	V <sub>GS</sub> =0V, I <sub>D</sub> =250uA	30			V
Zero Gate Voltage Drain Current	I <sub>DSS</sub>	V <sub>DS</sub> =24V, V <sub>GS</sub> =0V			1	uA
Gate-Body Leakage	I <sub>GSS</sub>	V <sub>GS</sub> = ±20V, V <sub>DS</sub> =0V			±100	nA
<b>ON CHARACTERISTICS<sup>b</sup></b>						
Gate Threshold Voltage	V <sub>GS(th)</sub>	V <sub>DS</sub> =V <sub>GS</sub> , I <sub>D</sub> = 250uA	1	1.7	2.5	V
Drain-Source On-State Resistance	R <sub>DS(ON)</sub>	V <sub>GS</sub> =10V, I <sub>D</sub> =7A		27	32	m ohm
		V <sub>GS</sub> = 4.5V, I <sub>D</sub> = 3.5A		52	57	m ohm
On-State Drain Current	I <sub>D(ON)</sub>	V <sub>DS</sub> = 5V, V <sub>GS</sub> = 10V	45			A
Forward Transconductance	g <sub>FS</sub>	V <sub>DS</sub> = 5V, I <sub>D</sub> =7A		8		S
<b>DYNAMIC CHARACTERISTICS<sup>c</sup></b>						
Input Capacitance	C <sub>ISS</sub>	V <sub>DS</sub> =15V, V <sub>GS</sub> = 0V f=1.0MHz		599		pF
Output Capacitance	C <sub>OSS</sub>			110		pF
Reverse Transfer Capacitance	C <sub>RSS</sub>			81		pF
<b>SWITCHING CHARACTERISTICS<sup>c</sup></b>						
Turn-On Delay Time	t <sub>D(ON)</sub>	V <sub>DD</sub> = 15V I <sub>D</sub> = 1A V <sub>GS</sub> = 10V R <sub>GEN</sub> = 10 ohm		9.7		ns
Rise Time	t <sub>r</sub>			15.4		ns
Turn-Off Delay Time	t <sub>D(OFF)</sub>			17.2		ns
Fall Time	t <sub>f</sub>			10.8		ns
Total Gate Charge	Q <sub>g</sub>	V <sub>DS</sub> =15V, I <sub>D</sub> =1A, V <sub>GS</sub> =10V		13		nC
		V <sub>DS</sub> =15V, I <sub>D</sub> =1A, V <sub>GS</sub> =4.5V		6.8		nC
Gate-Source Charge	Q <sub>gs</sub>	V <sub>DS</sub> =15V, I <sub>D</sub> = 1A V <sub>GS</sub> =10V		2.4		nC
Gate-Drain Charge	Q <sub>gd</sub>			3.1		nC

# STU/D9410

## ELECTRICAL CHARACTERISTICS ( $T_A=25^{\circ}\text{C}$ unless otherwise noted)

Parameter	Symbol	Condition	Min	Typ <sup>c</sup>	Max	Unit
<b>DRAIN-SOURCE DIODE CHARACTERISTICS<sup>b</sup></b>						
Diode Forward Voltage	$V_{SD}$	$V_{GS} = 0V, I_s = 20A$		1	1.3	V

### Notes

- a. Surface Mounted on FR4 Board,  $t \leq 10\text{sec}$ .
- b. Pulse Test: Pulse Width  $\leq 300\mu\text{s}$ , Duty Cycle  $\leq 2\%$ .
- c. Guaranteed by design, not subject to production testing.

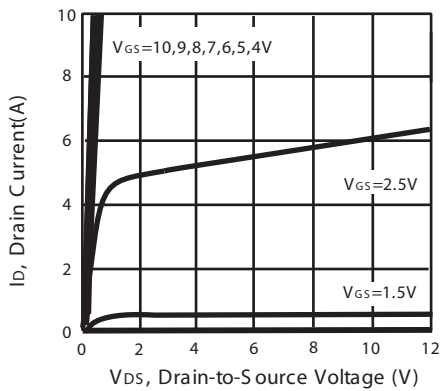

Figure 1. Output Characteristics

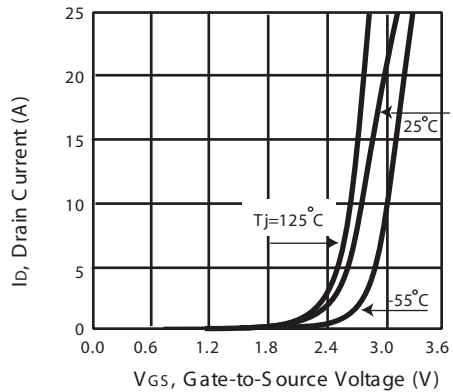

Figure 2. Transfer Characteristics

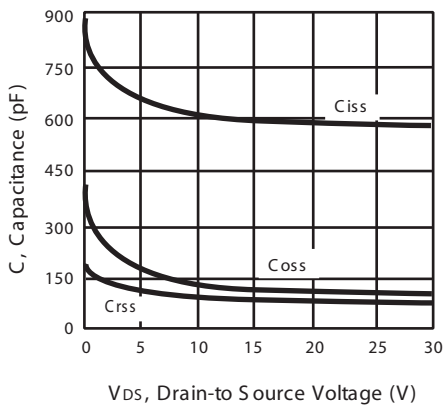

Figure 3. Capacitance

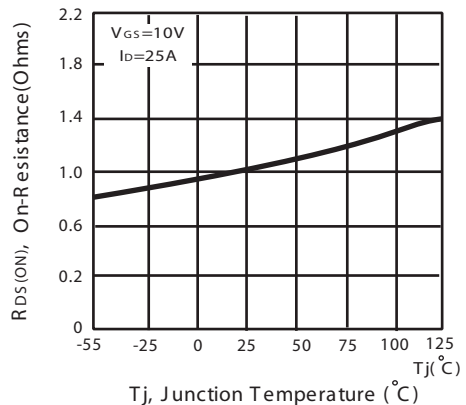

Figure 4. On-Resistance Variation with Drain Current and Temperature

# STU/D9410

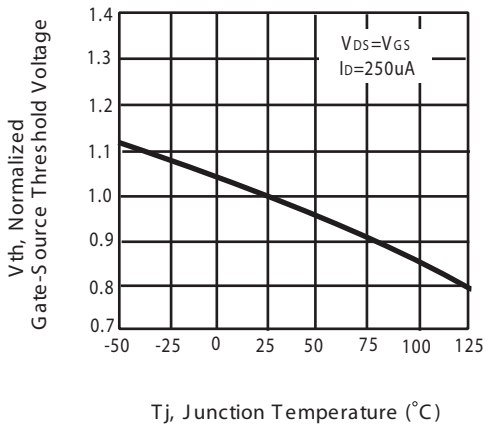

Figure 5. Gate Threshold Variation with Temperature

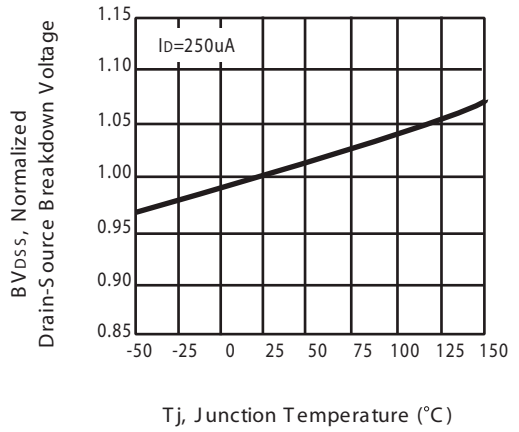

Figure 6. Breakdown Voltage Variation with Temperature

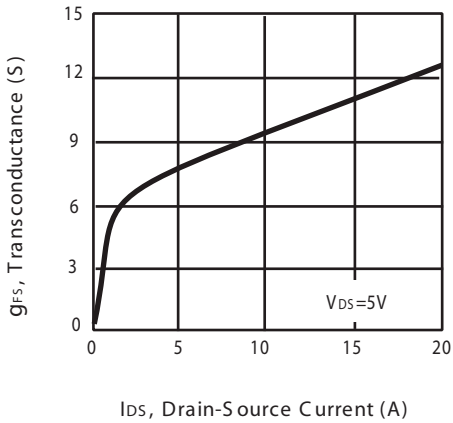

Figure 7. Transconductance Variation with Drain Current

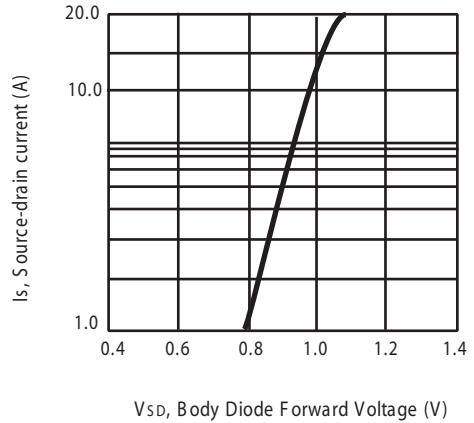

Figure 8. Body Diode Forward Voltage Variation with Source Current

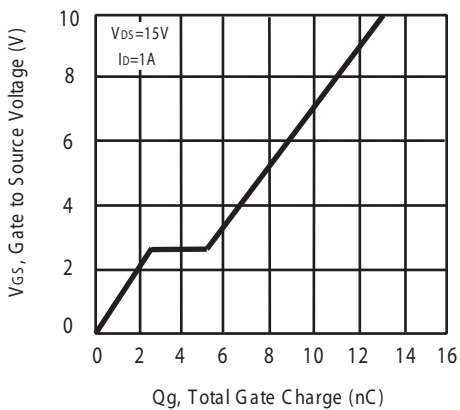

Figure 9. Gate Charge

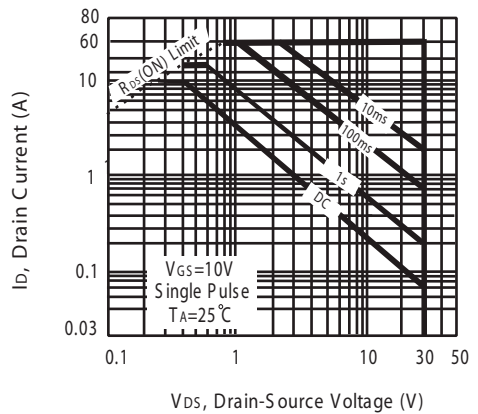

Figure 10. Maximum Safe Operating Area

# STU/D9410

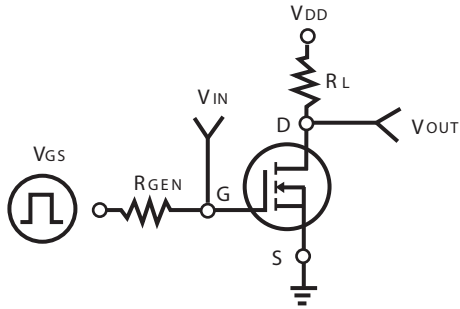

Figure 11. Switching Test Circuit

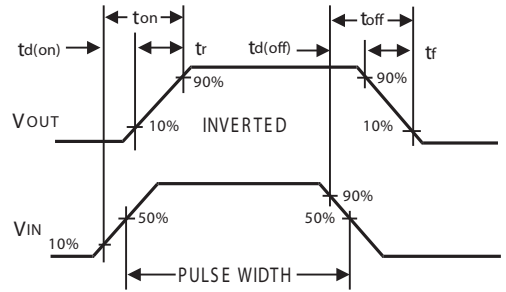

Figure 12. Switching Waveforms

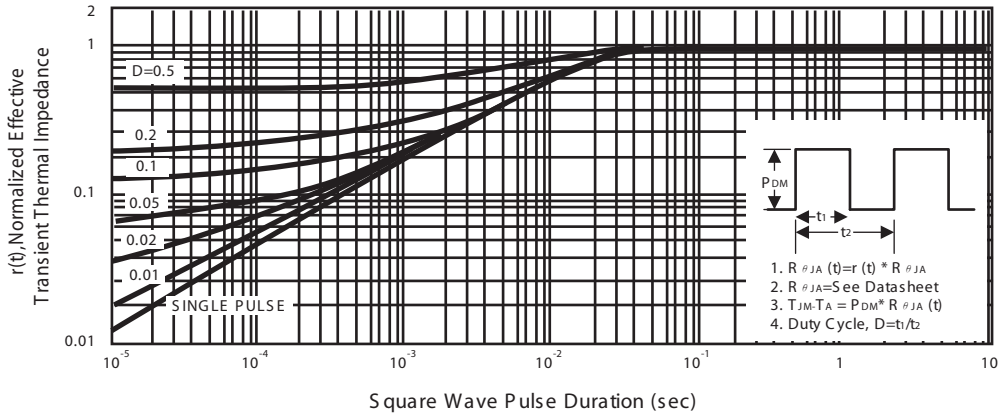
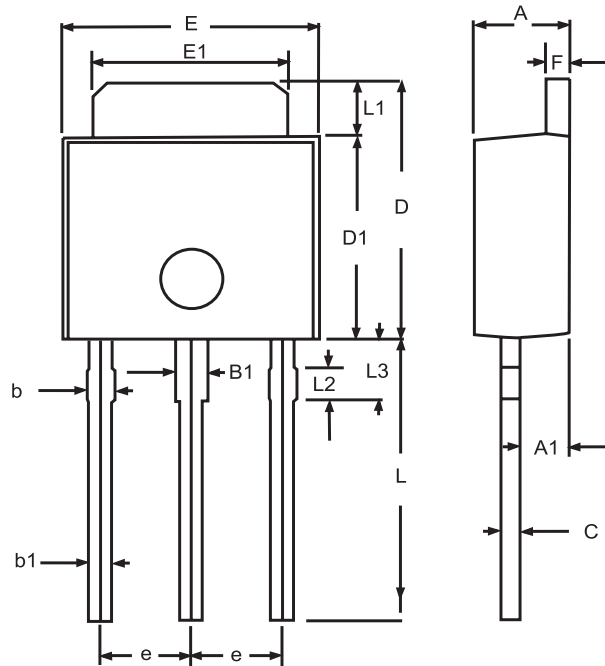

Figure 13. Normalized Thermal Transient Impedance Curve

# STU/D9410

## PACKAGE OUTLINE DIMENSIONS

### TO-251



SYMBOLS	MILLIMETERS		INCHES	
	MIN	MAX	MIN	MAX
A	2.20	2.40	0.087	0.095
A1	1.100	1.300	0.043	0.051
B1	0.650	1.050	0.026	0.041
b	0.500	0.900	0.020	0.035
b1	0.400	0.800	0.016	0.32
C	0.400	0.600	0.016	0.024
D	6.700	7.300	0.264	0.287
D1	5.400	5.650	0.213	0.222
E	6.40	6.650	0.252	0.262
e	2.100	2.500	0.083	0.098
F	0.400	0.600	0.016	0.024
L	7.000	8.000	0.276	0.315
L1	1.300	1.700	0.051	0.067
L2	0.700	0.900	0.028	0.035
L3	1.400	1.800	0.055	0.071

# STU/D9410

## PACKAGE OUTLINE DIMENSIONS

### TO-252

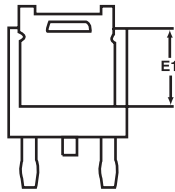
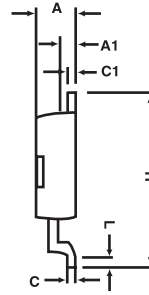
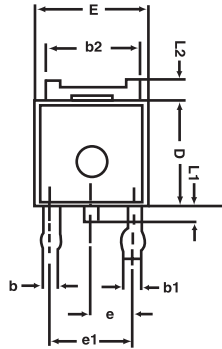

SYMBOLS	MILLIMETERS		INCHES	
	MIN	MAX	MIN	MAX
A	2.25	2.35	0.089	0.093
A1	0.95	1.05	0.037	0.041
b	0.77	0.85	0.030	0.033
b1	0.84	0.94	0.033	0.037
b2	5.30	5.45	0.209	0.215
C	0.49	0.53	0.019	0.021
D	6.00	6.20	0.236	0.244
E	6.40	6.60	0.252	0.260
E1	3.18	3.67	0.125	0.145
e	2.29	BSC	0.090	BSC
H	9.70	10.10	0.382	0.398
L	1.425	1.625	0.056	0.064
L1	0.650	0.850	0.026	0.033
L2	0.600	REF.	0.024	REF.

# STU/D9410

## TO251 Tube/TO-252 Tape and Reel Data

### TO-251 Tube



### TO-252 Carrier Tape

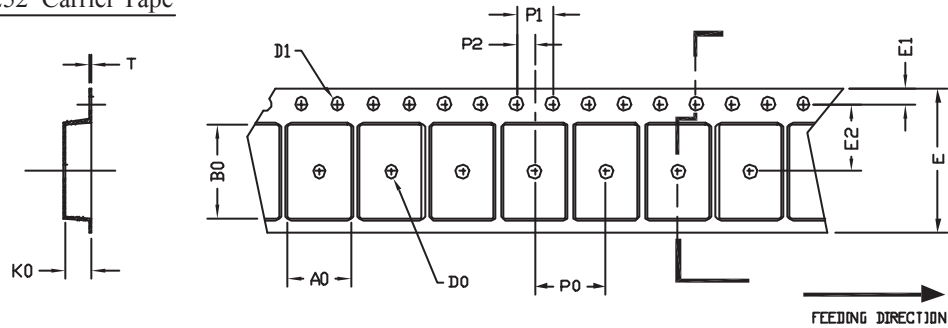

UNIT:mm

PACKAGE	A0	B0	K0	D0	D1	E	E1	E2	P0	P1	P2	T
TO-252 (16 mm)	6.80 $\pm 0.1$	10.3 $\pm 0.1$	2.50 $\pm 0.1$	$\phi 2$	$\phi 1.5$ $+ 0.1$ $- 0$	16.0 $0.3 \pm$	1.75 $0.1 \pm$	7.5 $\pm 0.15$	8.0 $\pm 0.1$	4.0 $\pm 0.1$	2.0 $\pm 0.15$	0.3 $\pm 0.05$

### TO-252 Reel



UNIT:mm

TAPE SIZE	REEL SIZE	M	N	W	T	H	K	S	G	R	V
16 mm	$\phi 330$	$\phi 330$ $\pm 0.5$	$\phi 97$ $\pm 1.0$	17.0 $+ 1.5$ $- 0$	2.2	$\phi 13.0$ $+ 0.5$ $- 0.2$	10.6	2.0 $\pm 0.5$	---	---	---