

### FEATURES

- Stable with low ESR Output Ceramic Capacitors
- Up to 99% On time
- 2A Output Current
- Wide Operating Input Voltage Range 5.5V to 32V
- Fixed 330 kHz Frequency
- Thermal Shutdown
- Cycle-by-cycle Over Current Protection
- Under Voltage Lockout
- 5V reference output
- Adjustable output from 0.6V

### APPLICATIONS

- Battery Chargers
- Portable (Notebook) Computers
- Industrial power supply
- Point of regulation for high performance electronics
- Consumer Electronics
- Audio Power Amplifiers
- Distributed Power Systems
- Pre-Regulator for Linear Regulators
- LCD TVs and LCD monitors
- Automotive electronics

### GENERAL DESCRIPTION

The AMS4154 is a step-down converter for high voltage applications. Current mode operation provides easier compensation and fast transient response. Internal cycle-by-cycle current limiting and thermal shutdown provides the necessary protection in faults situation. A 5V reference voltage is available that can supply up to 2mA current.

### ORDERING INFORMATION

OUTPUT	PACKAGE TYPE	TEMP. RANGE
VOLTAGE	8 Lead SOIC	
Adjustable	AMS4154S	-25°C to 125°C

### TYPICAL APPLICATION

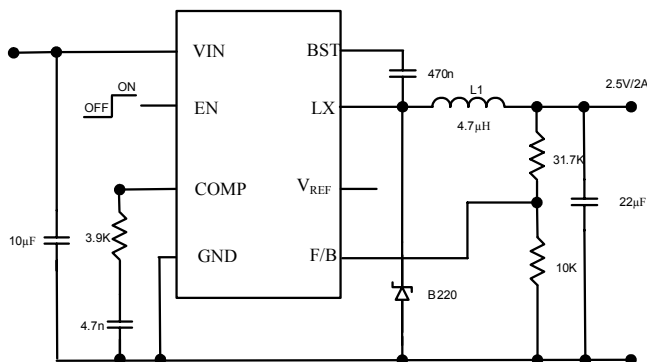

### PIN CONNECTIONS

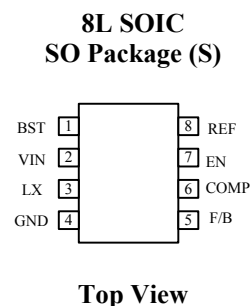

## PIN DESCRIPTION

AMS4154		
PIN NUMBERS	NAME	DESCRIPTION
1	BST	Bootstrap. A capacitor is needed to drive the power switch's drive above the supply voltage. It is connected between LX and BST pins to form a floating supply across the power switch driver.
2	VIN	Supply Voltage. The AMS4154 operates from a+5.5V to +32V unregulated input. C1 is needed to prevent large voltage spikes from appearing at the input.
3	LX	Switch. This connects the inductor to VIN through the internal power switch.
4	GND	Ground. This pin is the ground for voltage reference and for the regulated output voltage. For this reason care must be taken in its layout.
5	FB	Feedback. An external resistor divider from the output to GND, tapped to the FB pin sets the output voltage.
6	COMP	Compensation. This node is the output of the transconductance error amplifier and the input to the current comparator. Frequency compensation is done at this node by connecting a series R-C to ground.
7	EN	Enable. A voltage greater than 2.5V enables operation. For complete low current shutdown the EN pin voltage needs to be less than 2.3V.
8	REF	5V reference voltage capable of supplying 1mA for other external circuits.

## ABSOLUTE MAXIMUM RATINGS

Input Supply Voltage	-0.3V to +34V	Junction Temperature	+150°C
SW Voltage	-1V to $V_{IN} + 0.3V$	Storage Temperature	-65°C to +150°C
BS Voltage	$V_{LX} - 0.3V$ to $V_{LX} + 6V$	Lead Temperature	260°C
All Other Pins	-0.3V to +6V		

## ELECTRICAL CHARACTERISTICS

Electrical Characteristics at  $T_A = 25^\circ\text{C}$  and  $V_{IN} = 12V$  (unless otherwise noted).

PARAMETER	TEST CONDITIONS	AMS4154			Units
		Min.	Typ.	Max.	
Feedback Voltage	$0.6V \leq V_{IN} \leq 32V, V_{COMP} < 2V$	0.588	0.600	0.612	V
Supply Current	$V_{EN} = 5V, V_{FB} = 1.4V$		1.0	1.2	mA
Shutdown Supply Current	$V_{EN} = 0V$		0.5	1	$\mu\text{A}$
Current Limit		2.5	3.6	4.9	A
Current Sense to COMP Transconductance			3.5		A/V
Oscillation Frequency		280	330	380	KHz
Maximum Duty Cycle	$V_{FB} = 1.0V$		90	99	%
Minimum Duty Cycle	$V_{FB} = 1.5V$		0		%
EN Threshold Voltage	$V_{EN}$ Rising, Output ON	2.5	2.6	2.8	V
EN Threshold Voltage	$V_{EN}$ Falling, Output OFF		2.2	2.3	V
EN Threshold Hysteresis			250		mV
Enable Current	$V_{EN} = 0V$		1.8		$\mu\text{A}$
Thermal Shutdown			160		$^\circ\text{C}$
5V REF Voltage	$I_{REF} = 0$	4.8	5.0	5.2	V
REF Load Regulation	$\Delta I_{REF} = 0$ to 1mA		100		mV
REF Line Regulation	$I_{REF} = 100\mu\text{A}, V_{IN} = 6.5$ to 32V		30		mV

## TYPICAL WAVEFORM

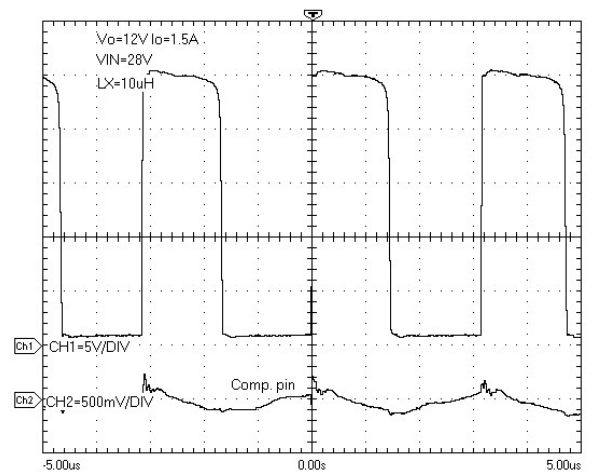
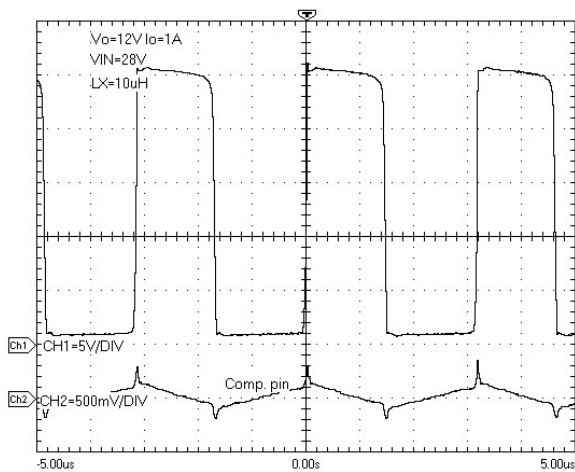
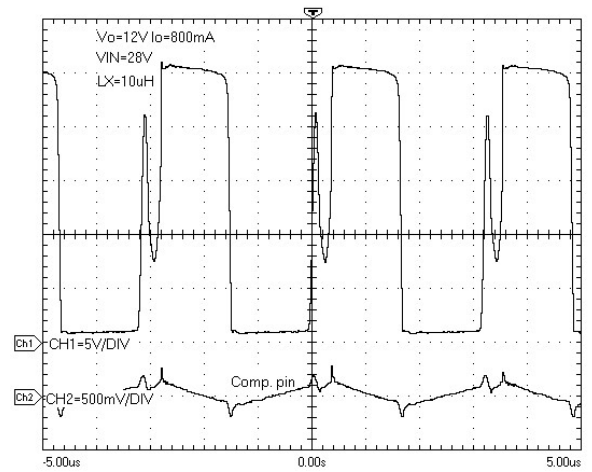
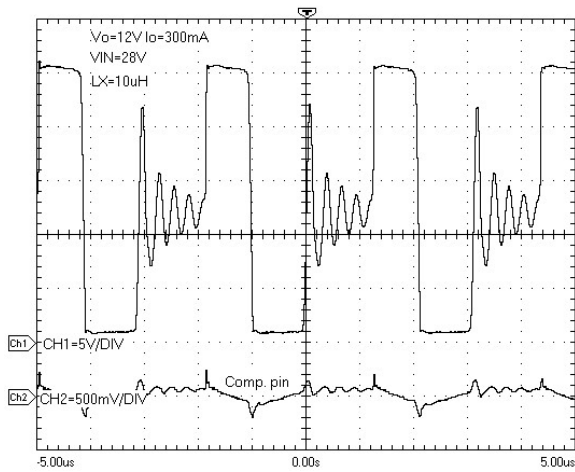

**PACKAGE DIMENSIONS** inches (millimeters) unless otherwise noted.

## 8 LEAD SOIC PLASTIC PACKAGE (S)

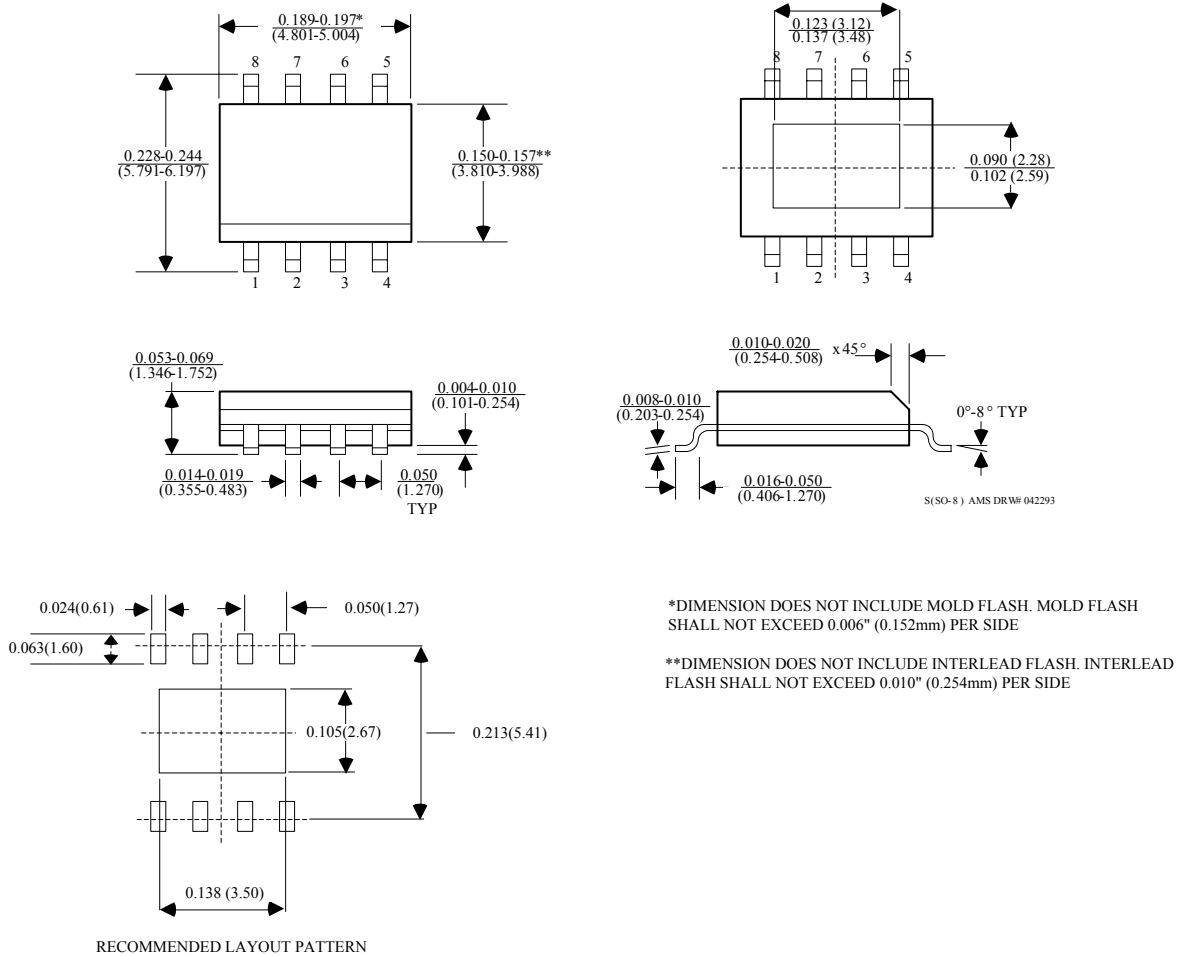

\*DIMENSION DOES NOT INCLUDE MOLD FLASH. MOLD FLASH SHALL NOT EXCEED 0.006" (0.152mm) PER SIDE

\*\*DIMENSION DOES NOT INCLUDE INTERLEAD FLASH. INTERLEAD FLASH SHALL NOT EXCEED 0.010" (0.254mm) PER SIDE

S(SO-8) AMS DRW 042293