

POWER MOS 7® IGBT

The POWER MOS 7® IGBT is a new generation of high voltage power IGBTs. Using Punch Through Technology this IGBT is ideal for many high frequency, high voltage switching applications and has been optimized for high frequency switchmode power supplies.

- Low Conduction Loss
- Low Gate Charge
- Ultrafast Tail Current shutoff
- SSOA rated

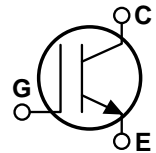
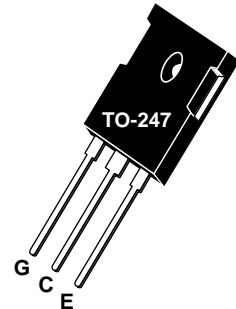

MAXIMUM RATINGS

 All Ratings: $T_C = 25^\circ\text{C}$ unless otherwise specified.

Symbol	Parameter	APT32GU30B	UNIT
V_{CES}	Collector-Emitter Voltage	300	Volts
V_{GE}	Gate-Emitter Voltage	± 20	
V_{GEM}	Gate-Emitter Voltage Transient	± 30	
I_{C1}	Continuous Collector Current @ $T_C = 25^\circ\text{C}$	55	Amps
I_{C2}	Continuous Collector Current @ $T_C = 100^\circ\text{C}$	32	
I_{CM}	Pulsed Collector Current ^① @ $T_C = 150^\circ\text{C}$	120	
SSOA	Switching Safe Operating Area @ $T_J = 150^\circ\text{C}$	120A @ 300V	
P_D	Total Power Dissipation	250	Watts
T_J, T_{STG}	Operating and Storage Junction Temperature Range	-55 to 150	$^\circ\text{C}$
T_L	Max. Lead Temp. for Soldering: 0.063" from Case for 10 Sec.	300	

STATIC ELECTRICAL CHARACTERISTICS

Symbol	Characteristic / Test Conditions	MIN	TYP	MAX	UNIT
BV_{CES}	Collector-Emitter Breakdown Voltage ($V_{GE} = 0V, I_C = 250\mu\text{A}$)	300			Volts
$V_{GE(TH)}$	Gate Threshold Voltage ($V_{CE} = V_{GE}, I_C = 1\text{mA}, T_J = 25^\circ\text{C}$)	3	4.5	6	
$V_{CE(ON)}$	Collector-Emitter On Voltage ($V_{GE} = 15V, I_C = 15A, T_J = 25^\circ\text{C}$)		1.5	2.0	
	Collector-Emitter On Voltage ($V_{GE} = 15V, I_C = 15A, T_J = 125^\circ\text{C}$)		1.5		
I_{CES}	Collector Cut-off Current ($V_{CE} = V_{CES}, V_{GE} = 0V, T_J = 25^\circ\text{C}$) ^②			250	μA
	Collector Cut-off Current ($V_{CE} = V_{CES}, V_{GE} = 0V, T_J = 125^\circ\text{C}$) ^②			2500	
I_{GES}	Gate-Emitter Leakage Current ($V_{GE} = \pm 20V$)			± 100	nA

 **CAUTION:** These Devices are Sensitive to Electrostatic Discharge. Proper Handling Procedures Should Be Followed.

DYNAMIC CHARACTERISTICS

APT32GU30B

Symbol	Characteristic	Test Conditions	MIN	TYP	MAX	UNIT
C_{ies}	Input Capacitance	Capacitance $V_{GE} = 0V, V_{CE} = 25V$ $f = 1 \text{ MHz}$		1660		pF
C_{oes}	Output Capacitance			170		
C_{res}	Reverse Transfer Capacitance			13		
V_{GEP}	Gate-to-Emitter Plateau Voltage	Gate Charge $V_{GE} = 15V$ $V_{CE} = 150V$ $I_C = 15A$		7.0		V
Q_g	Total Gate Charge ^③			57		nC
Q_{ge}	Gate-Emitter Charge			11		
Q_{gc}	Gate-Collector ("Miller") Charge			17		
SSOA	Switching Safe Operating Area	$T_J = 150^\circ\text{C}, R_G = 5\Omega, V_{GE} = 15V, L = 100\mu\text{H}, V_{CE} = 300V$	120			A
$t_{d(on)}$	Turn-on Delay Time	Inductive Switching (25°C) $V_{CC} = 200V$ $V_{GE} = 15V$ $I_C = 15A$ $R_G = 20\Omega$ $T_J = +25^\circ\text{C}$		28		ns
t_r	Current Rise Time			13		
$t_{d(off)}$	Turn-off Delay Time			127		
t_f	Current Fall Time			63		
E_{on1}	Turn-on Switching Energy ^④				TBD	μJ
E_{on2}	Turn-on Switching Energy (Diode) ^⑤				36	
E_{off}	Turn-off Switching Energy ^⑥				66	
$t_{d(on)}$	Turn-on Delay Time	Inductive Switching (125°C) $V_{CC} = 200V$ $V_{GE} = 15V$ $I_C = 15A$ $R_G = 20\Omega$ $T_J = +125^\circ\text{C}$		28		ns
t_r	Current Rise Time			13		
$t_{d(off)}$	Turn-off Delay Time			155		
t_f	Current Fall Time			119		
E_{on1}	Turn-on Switching Energy ^④				TBD	μJ
E_{on2}	Turn-on Switching Energy (Diode) ^⑤				76	
E_{off}	Turn-off Switching Energy ^⑥				111	

THERMAL AND MECHANICAL CHARACTERISTICS

Symbol	Characteristic	MIN	TYP	MAX	UNIT
$R_{\theta JC}$	Junction to Case (IGBT)			0.50	°C/W
$R_{\theta JC}$	Junction to Case (DIODE)			N/A	
W_T	Package Weight			5.90	gm

① Repetitive Rating: Pulse width limited by maximum junction temperature.

② For Combi devices, I_{ces} includes both IGBT and FRED leakages

③ See MIL-STD-750 Method 3471.

④ E_{on1} is the clamped inductive turn-on-energy of the IGBT only, without the effect of a commutating diode reverse recovery current adding to the IGBT turn-on loss. (See Figure 24.)

⑤ E_{on2} is the clamped inductive turn-on energy that includes a commutating diode reverse recovery current in the IGBT turn-on switching loss. A Combi device is used for the clamping diode as shown in the E_{on2} test circuit. (See Figures 21, 22.)

⑥ E_{off} is the clamped inductive turn-off energy measured in accordance with JEDEC standard JESD24-1. (See Figures 21, 23.)

APT Reserves the right to change, without notice, the specifications and information contained herein.

TYPICAL PERFORMANCE CURVES

APT32GU30B

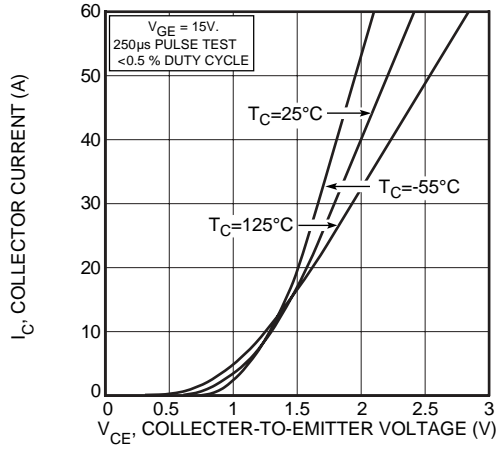

FIGURE 1, Output Characteristics ($V_{GE} = 15V$)

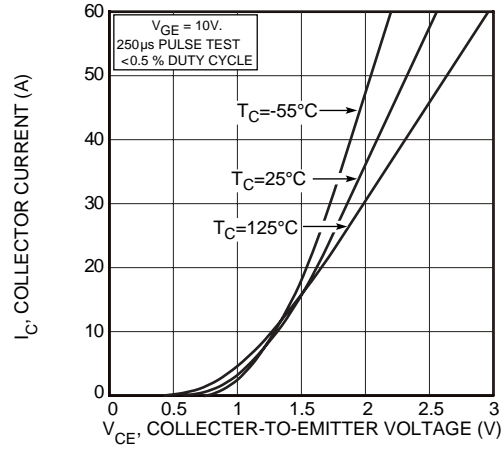

FIGURE 2, Output Characteristics ($V_{GE} = 10V$)

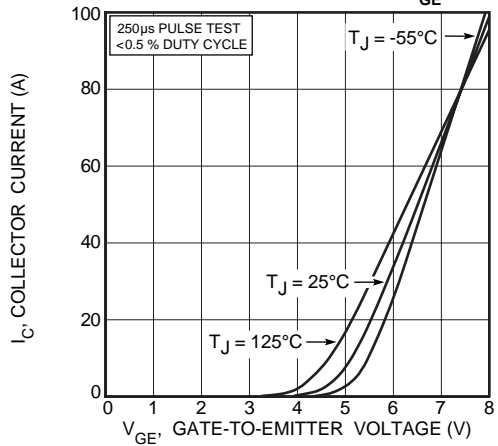

FIGURE 3, Transfer Characteristics

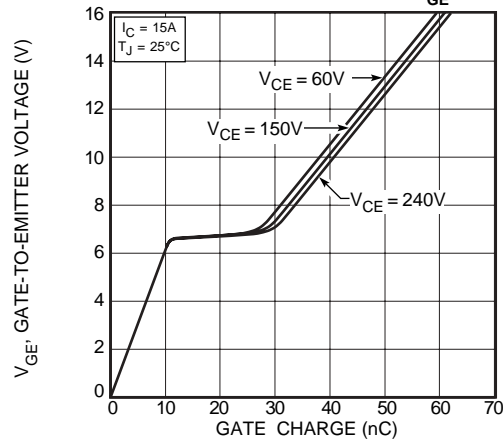

FIGURE 4, Gate Charge

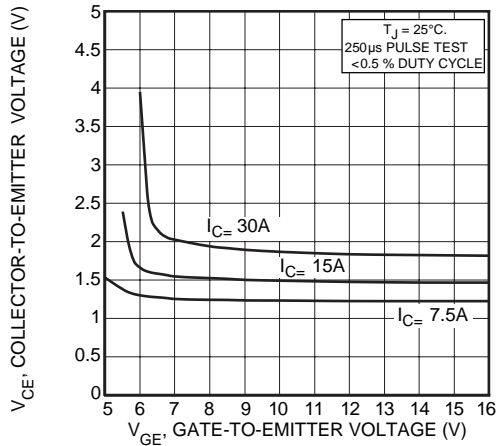

FIGURE 5, On State Voltage vs Gate-to-Emitter Voltage

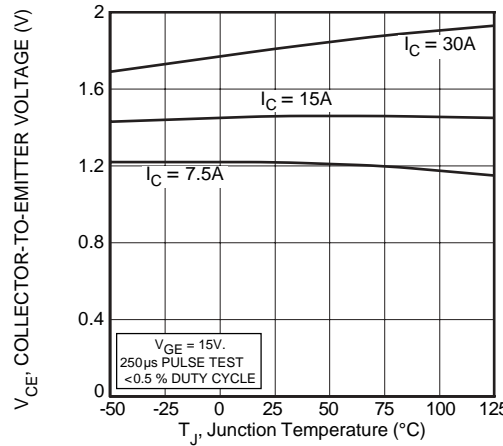

FIGURE 6, On State Voltage vs Junction Temperature

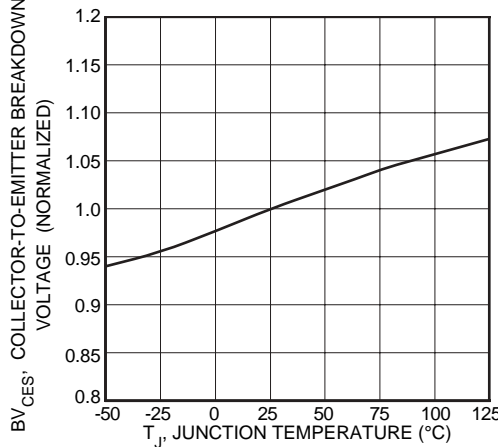

FIGURE 7, Breakdown Voltage vs. Junction Temperature

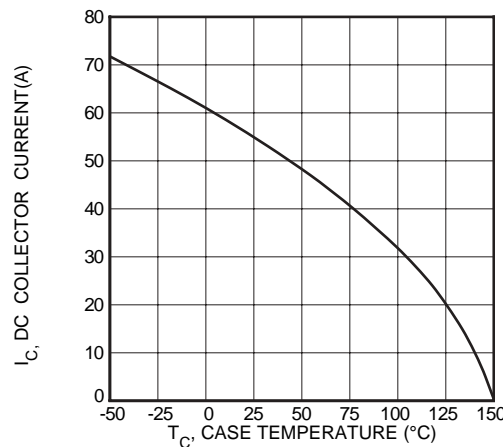

FIGURE 8, DC Collector Current vs Case Temperature

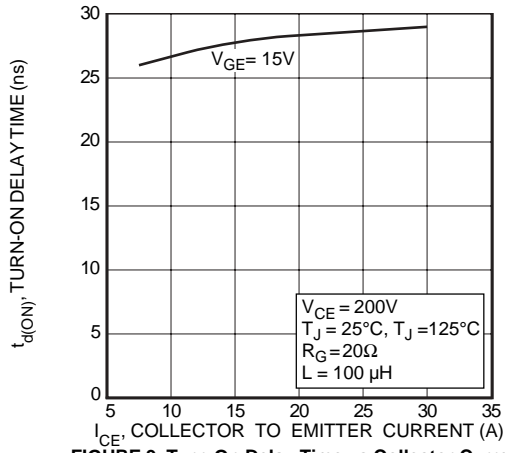

FIGURE 9, Turn-On Delay Time vs Collector Current

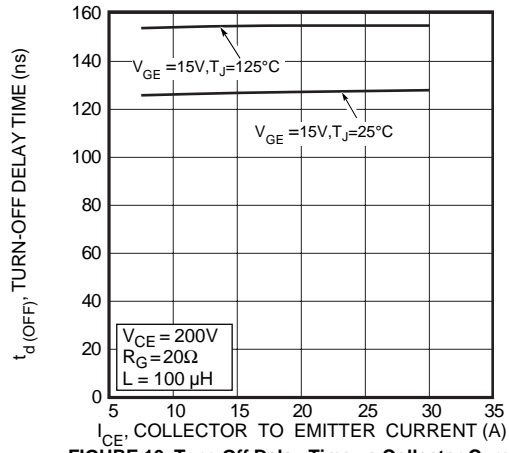

FIGURE 10, Turn-Off Delay Time vs Collector Current

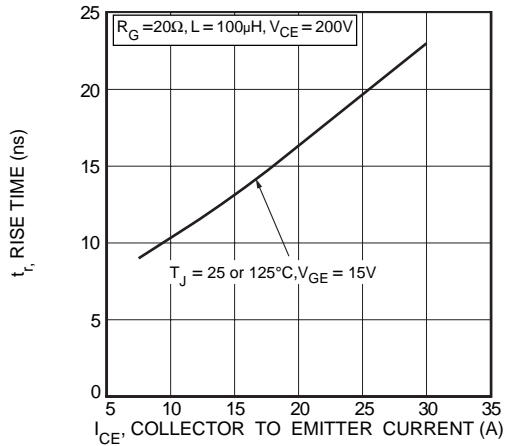

FIGURE 11, Current Rise Time vs Collector Current

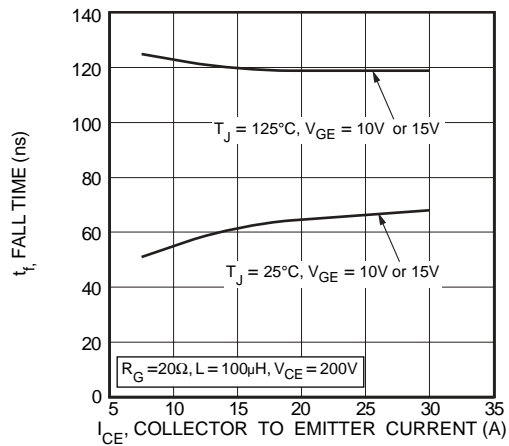

FIGURE 12, Current Fall Time vs Collector Current

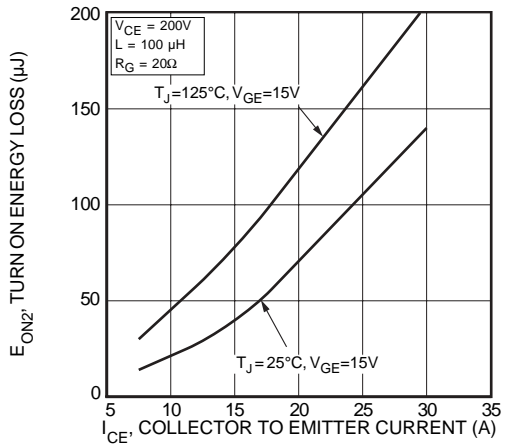

FIGURE 13, Turn-On Energy Loss vs Collector Current

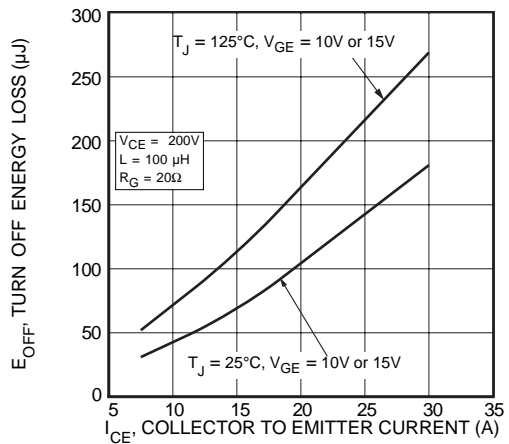

FIGURE 14, Turn Off Energy Loss vs Collector Current

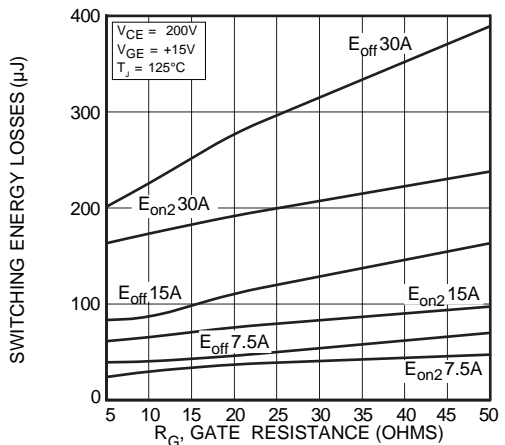

FIGURE 15, Switching Energy Losses vs. Gate Resistance

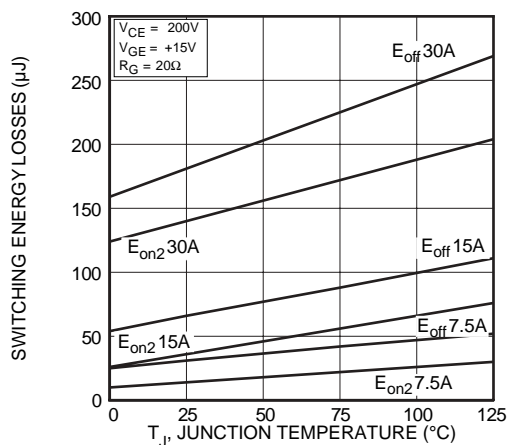

FIGURE 16, Switching Energy Losses vs Junction Temperature

TYPICAL PERFORMANCE CURVES

APT32GU30B

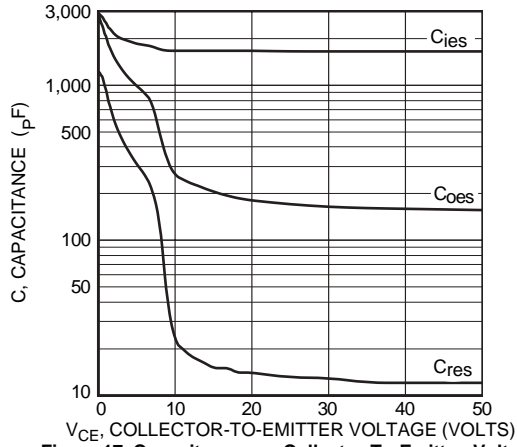

Figure 17, Capacitance vs Collector-To-Emitter Voltage

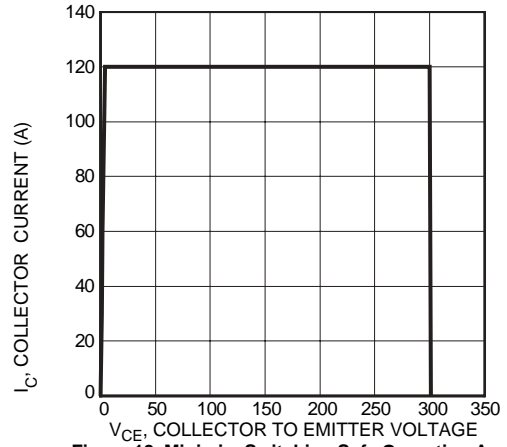

Figure 18, Minimum Switching Safe Operating Area

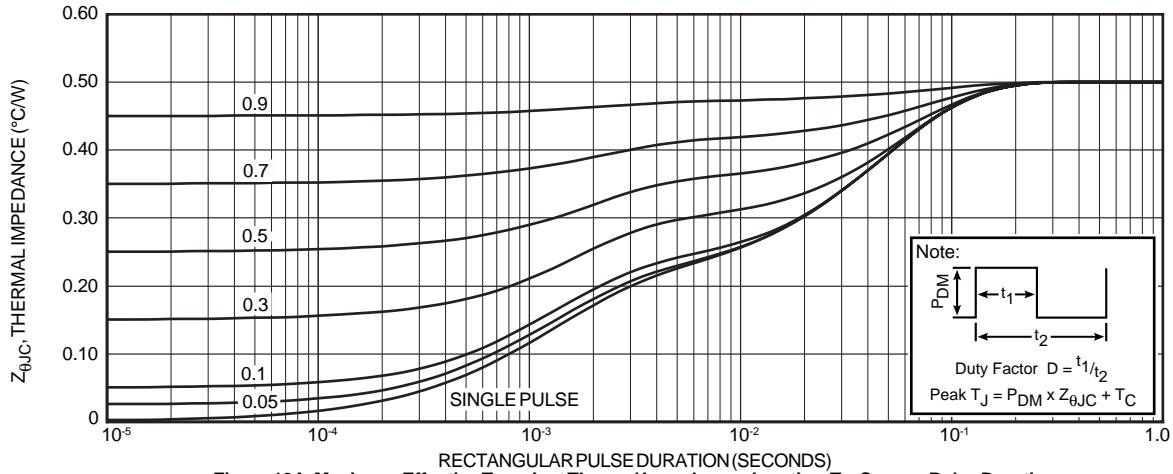

Figure 19A, Maximum Effective Transient Thermal Impedance, Junction-To-Case vs Pulse Duration

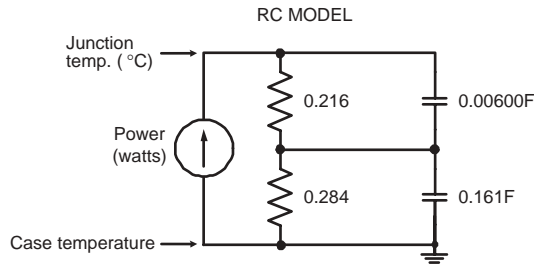

FIGURE 19B, TRANSIENT THERMAL IMPEDANCE MODEL

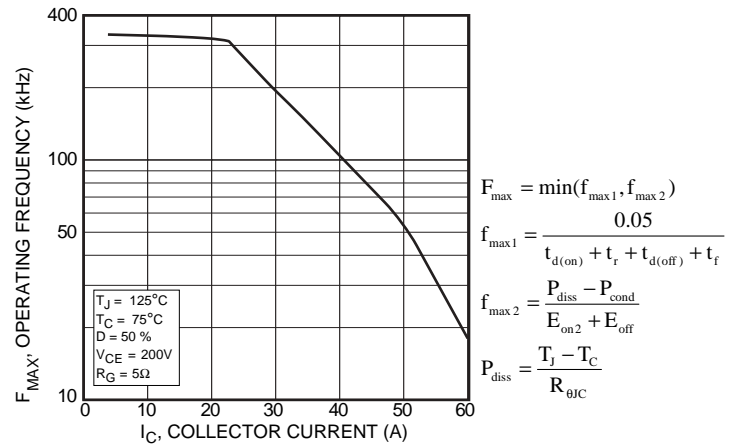

Figure 20, Operating Frequency vs Collector Current

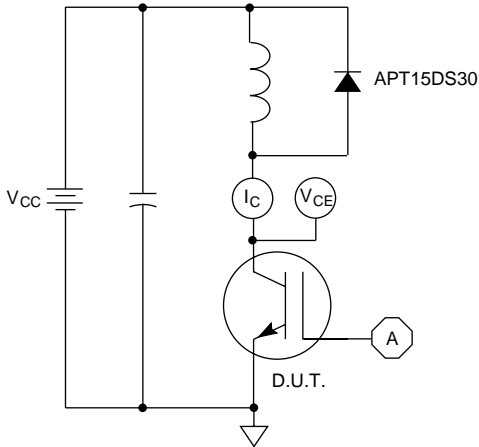

Figure 21, Inductive Switching Test Circuit

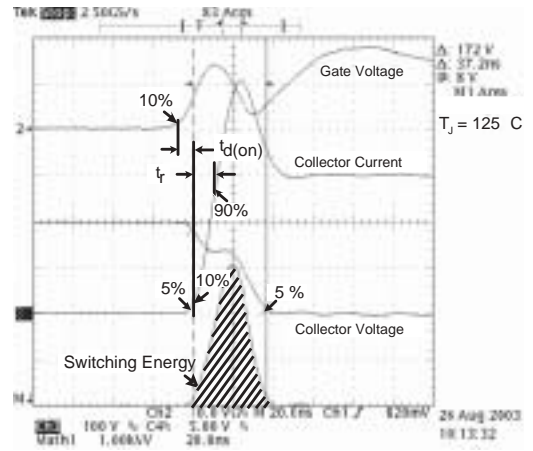

Figure 22, Turn-on Switching Waveforms and Definitions

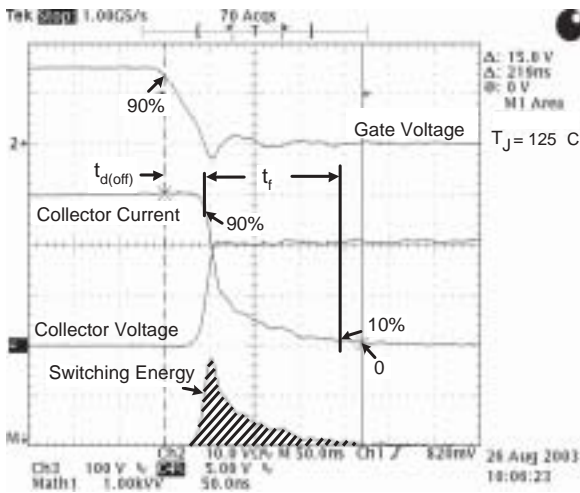

Figure 23, Turn-off Switching Waveforms and Definitions

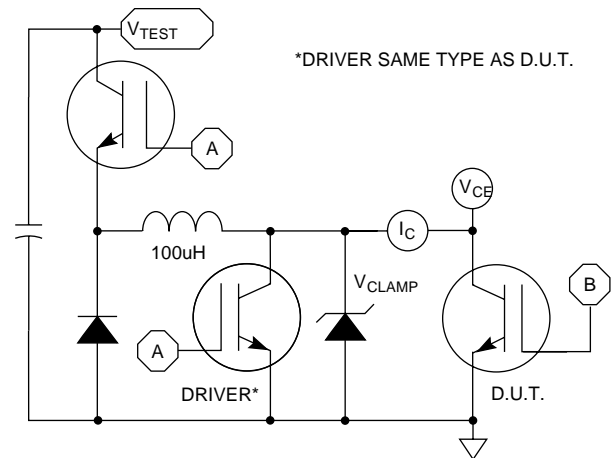
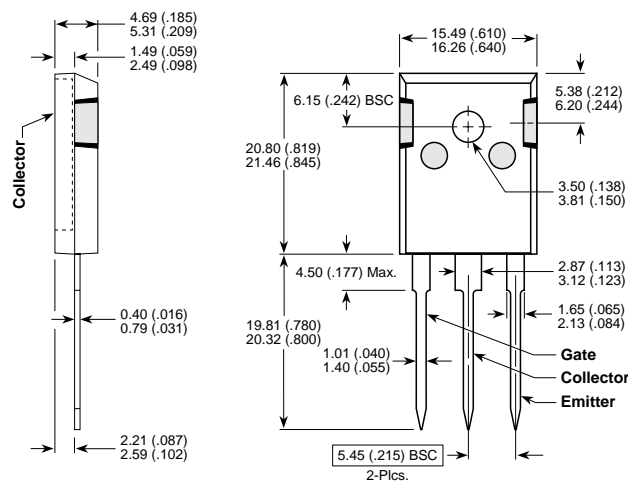

Figure 24, E_{ON1} Test Circuit

T0-247 Package Outline



Dimensions in Millimeters and (Inches)