

ULTRAFAST SOFT RECOVERY RECTIFIER DIODE
PRODUCT APPLICATIONS

- Anti-Parallel Diode
 - Switchmode Power Supply
 - Inverters
- Free Wheeling Diode
 - Motor Controllers
 - Converters
 - Inverters
- Snubber Diode
- PFC

PRODUCT FEATURES

- Ultrafast Recovery Times
- Soft Recovery Characteristics
- Popular TO-220 Isolated Full Package
- Low Forward Voltage
- Low Leakage Current
- Avalanche Energy Rated

PRODUCT BENEFITS

- Low Losses
- Low Noise Switching
- Cooler Operation
- Higher Reliability Systems
- Increased System Power Density

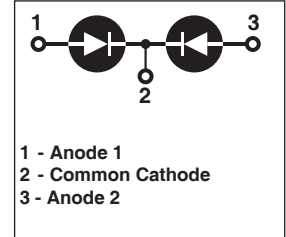
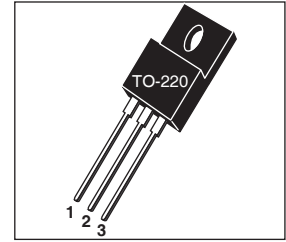
MAXIMUM RATINGS

 All Ratings Per Leg: $T_C = 25^\circ\text{C}$ unless otherwise specified.

Symbol	Characteristic / Test Conditions	APT8DQ60K3CT(G)	UNIT
V_R	Maximum D.C. Reverse Voltage	600	Volts
V_{RRM}	Maximum Peak Repetitive Reverse Voltage		
V_{RWM}	Maximum Working Peak Reverse Voltage		
$I_{F(AV)}$	Maximum Average Forward Current ($T_C = 82^\circ\text{C}$, Duty Cycle = 0.5)	8	Amps
$I_{F(RMS)}$	RMS Forward Current (Square wave, 50% duty)	10	
I_{FSM}	Non-Repetitive Forward Surge Current ($T_J = 45^\circ\text{C}$, 8.3ms)	110	
E_{AVL}	Avalanche Energy (1A, 40mH)	20	mJ
T_J, T_{STG}	Operating and Storage Temperature Range	-55 to 175	°C
T_L	Lead Temperature for 10 Sec.	300	

STATIC ELECTRICAL CHARACTERISTICS

Symbol	Characteristic / Test Conditions	MIN	TYP	MAX	UNIT
V_F	Forward Voltage	$I_F = 8\text{A}$	2.0	2.4	Volts
		$I_F = 16\text{A}$	2.5		
		$I_F = 8\text{A}, T_J = 125^\circ\text{C}$	1.5		
I_{RM}	Maximum Reverse Leakage Current	$V_R = 600\text{V}$		25	μA
		$V_R = 600\text{V}, T_J = 125^\circ\text{C}$		500	
C_T	Junction Capacitance, $V_R = 200\text{V}$		16		pF

DYNAMIC CHARACTERISTICS

APT8DQ60K3CT(G)

Symbol	Characteristic	Test Conditions	MIN	TYP	MAX	UNIT
t_{rr}	Reverse Recovery Time	$I_F = 1A, di_F/dt = -100A/\mu s, V_R = 30V, T_J = 25^\circ C$	-	14		ns
t_{rr}	Reverse Recovery Time		-	19		
Q_{rr}	Reverse Recovery Charge	$I_F = 8A, di_F/dt = -200A/\mu s, V_R = 400V, T_C = 25^\circ C$	-	17		nC
I_{RRM}	Maximum Reverse Recovery Current		-	2	-	Amps
t_{rr}	Reverse Recovery Time	$I_F = 8A, di_F/dt = -200A/\mu s, V_R = 400V, T_C = 125^\circ C$	-	90		ns
Q_{rr}	Reverse Recovery Charge		-	160		nC
I_{RRM}	Maximum Reverse Recovery Current		-	3	-	Amps
t_{rr}	Reverse Recovery Time	$I_F = 8A, di_F/dt = -1000A/\mu s, V_R = 400V, T_C = 125^\circ C$	-	43		ns
Q_{rr}	Reverse Recovery Charge		-	250		nC
I_{RRM}	Maximum Reverse Recovery Current		-	11		Amps

THERMAL AND MECHANICAL CHARACTERISTICS

Symbol	Characteristic / Test Conditions	MIN	TYP	MAX	UNIT
$R_{\theta JC}$	Junction-to-Case Thermal Resistance			5.4	$^\circ C/W$
W_T	Package Weight		0.07		oz
			1.9		g
Torque	Maximum Mounting Torque			10	lb•in
				1.1	N•m

APT Reserves the right to change, without notice, the specifications and information contained herein.

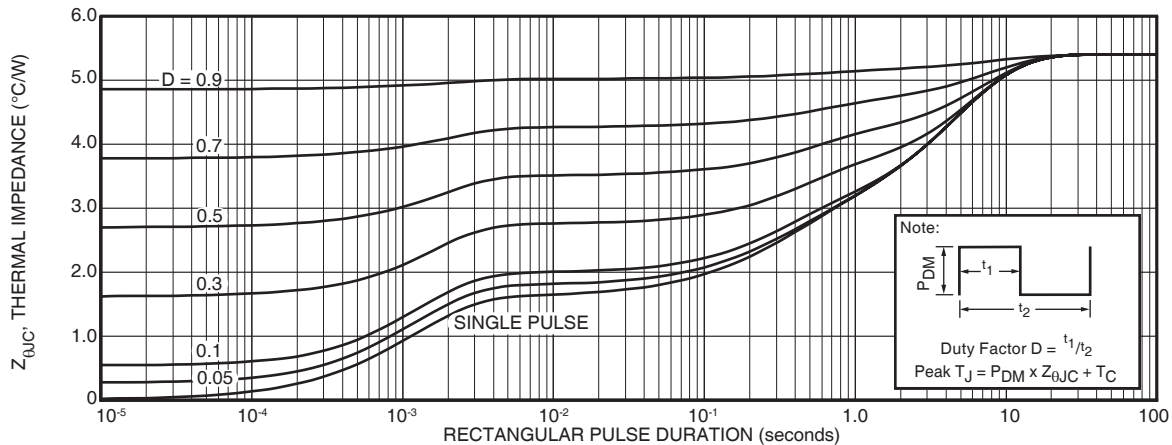

FIGURE 1a. MAXIMUM EFFECTIVE TRANSIENT THERMAL IMPEDANCE, JUNCTION-TO-CASE vs. PULSE DURATION

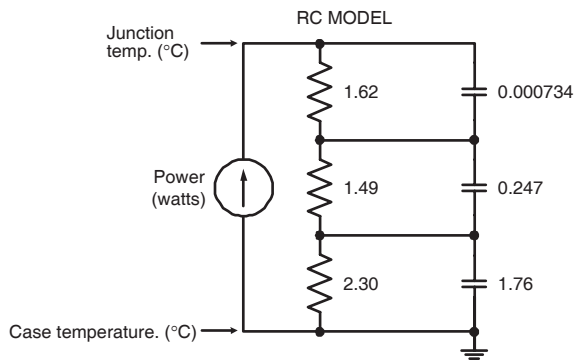

FIGURE 1b. TRANSIENT THERMAL IMPEDANCE MODEL

TYPICAL PERFORMANCE CURVES

APT8DQ60K3CT(G)

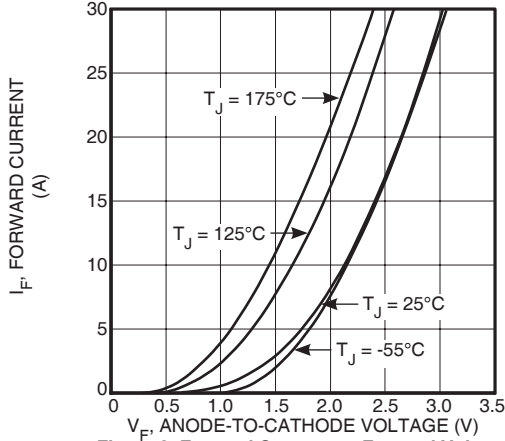

Figure 2. Forward Current vs. Forward Voltage

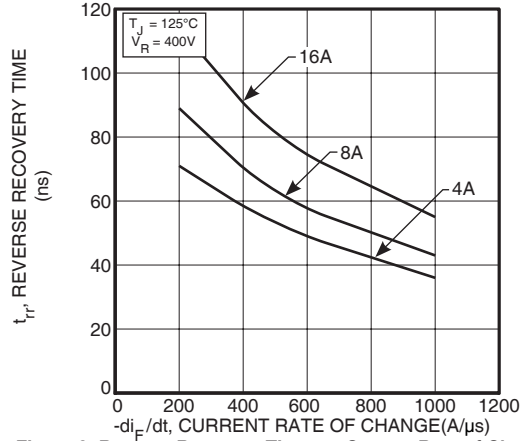

Figure 3. Reverse Recovery Time vs. Current Rate of Change

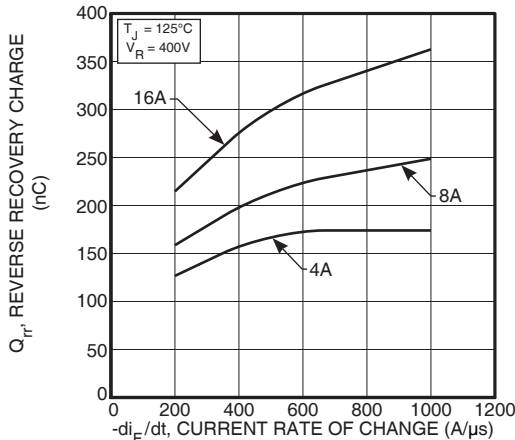

Figure 4. Reverse Recovery Charge vs. Current Rate of Change

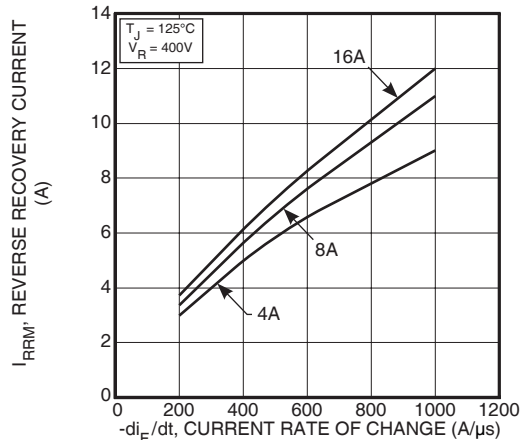

Figure 5. Reverse Recovery Current vs. Current Rate of Change

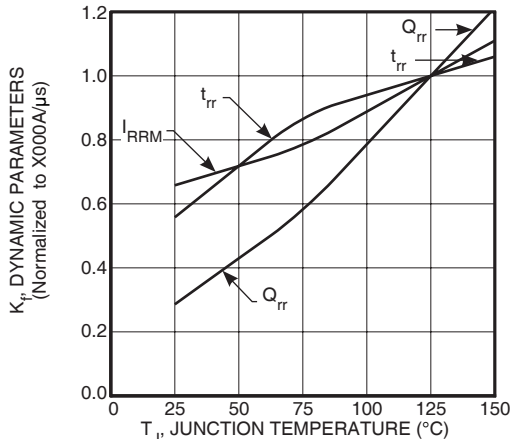

Figure 6. Dynamic Parameters vs. Junction Temperature

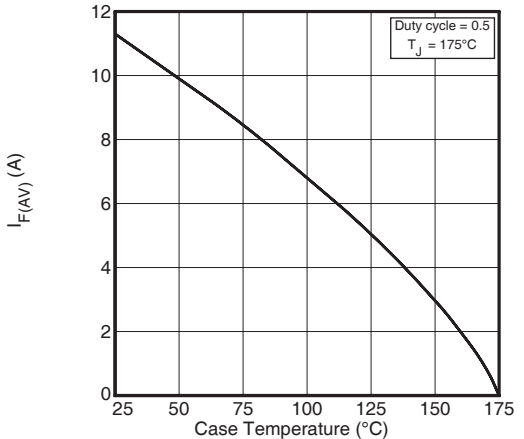

Figure 7. Maximum Average Forward Current vs. Case Temperature

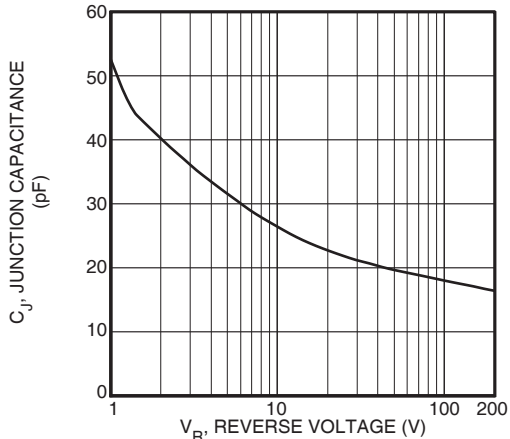

Figure 8. Junction Capacitance vs. Reverse Voltage

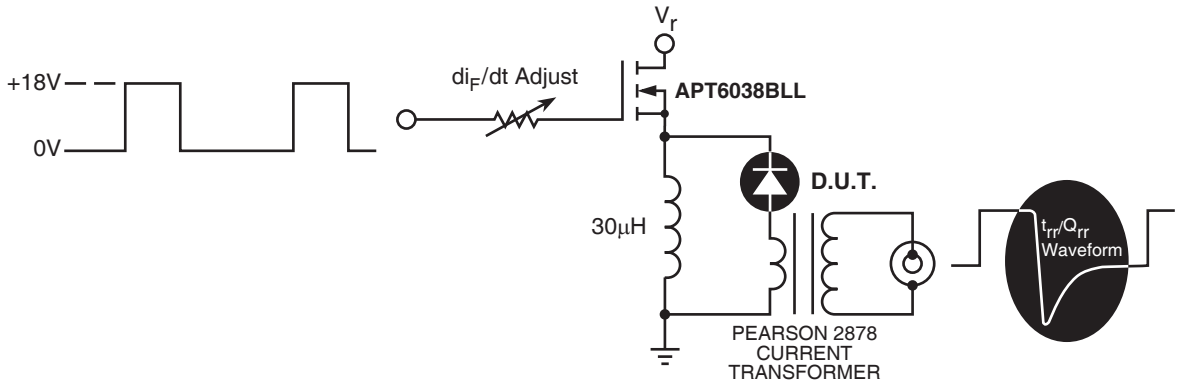

Figure 9. Diode Test Circuit

- 1 I_F - Forward Conduction Current
- 2 di_F/dt - Rate of Diode Current Change Through Zero Crossing.
- 3 I_{RRM} - Maximum Reverse Recovery Current.
- 4 t_{rr} - Reverse Recovery Time, measured from zero crossing where diode current goes from positive to negative, to the point at which the straight line through I_{RRM} and $0.25 \cdot I_{RRM}$ passes through zero.
- 5 Q_{rr} - Area Under the Curve Defined by I_{RRM} and t_{rr} .

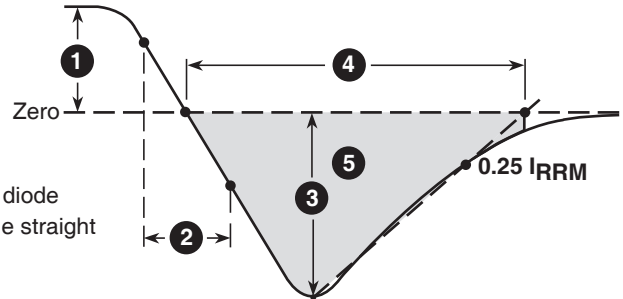
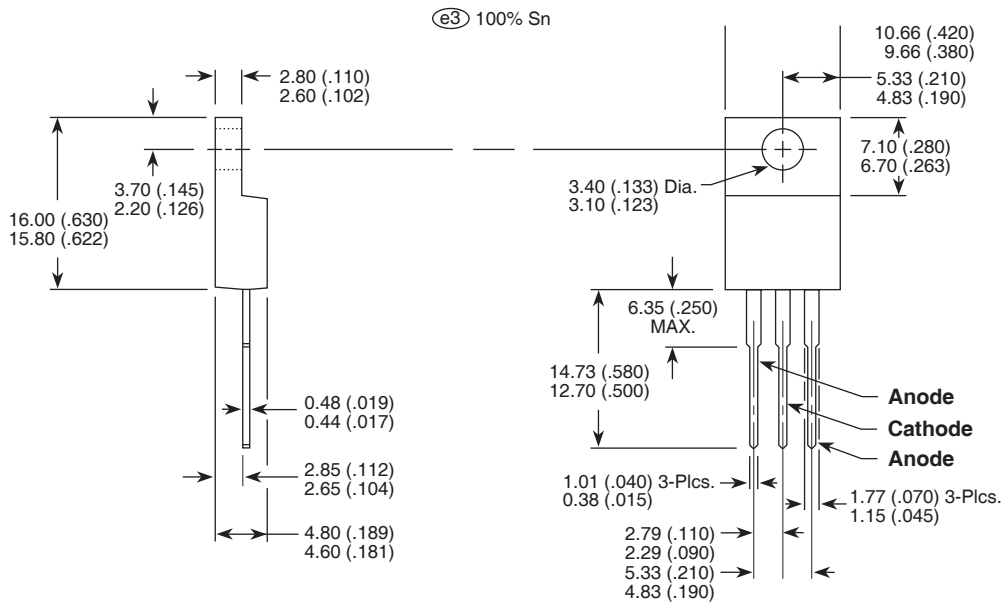

Figure 10, Diode Reverse Recovery Waveform and Definitions

TO-220 (K3CT) Package Outline



Dimensions in Millimeters and (Inches)

APT's products are covered by one or more of U.S. patents 4,895,810 5,045,903 5,089,434 5,182,234 5,019,522 5,262,336 6,503,786 5,256,583 4,748,103 5,283,202 5,231,474 5,434,095 5,528,058 and foreign patents. US and Foreign patents pending. All Rights Reserved.