

Features

- 3 3/4 digits manual and bargraph display
- Multiple function system
 - ◆ Logic probe, logic high level 4.0V, 2.4V, 1.5V selectable, 20 MHz
 - ◆ Analog to digital converter
 - ◆ Frequency counter (400 MHz)
 - ◆ OP amplifier
- Full scale range change by $\times 2$, $\times 10$, $\times 20$, $\div 5$, $\div 10$
- Peak hold, catch the P_{MAX} and P_{MIN} (<10 us)
- Data hold, MAX/MIN hold, Relative data function
- ZOOM function of bargraph
- Overrange outputs, can be controlled by RANGE pin
- PH1~PH4 for capacitor measurement
- RS232
- Low battery detect for 3V/9V battery
- Crystal or on chip RC oscillator
- Auto-power-off then hold the final data and re-power-on function
- Reset function
- Back light function
- Voltage reference for resistor measurement
- Point setting, bargraph disable
- On chip buzzer driver
- LCD segment check
- 3V DC power supply
- 100 Pin flat-package

Description

The ES51961 is a 3 3/4 digits and bargraph LCD display measurement system which combines integrated analog-to-digital converter (ADC), frequency counter, logic level tester and OP amplifier, which is operated with 3V DC power supply.

The ES51961 is suited to voltage, current, resistance, diode, continuity, temperature, logic probe and frequency measurement to 400 MHz. The frequency counter can automatically adjust its range to match the input frequency or manual setting, over six ranges selectable.

The logic level probe permits ES51961 to function as a logic probe and display logic high voltage level on the LCD display and turn on a piezoelectric buzzer.

The other functions are provided for MAX and MIN holding, data holding, peak data holding, relative data, low battery detection, backlight, zoom, reset, range, auto-power-off, re-power-on circuit and RS232 data output.

Absolute Maximum Ratings

Characteristics	Ratings
Supply Voltage (V- to AGND)	-4V
Analog Input Voltage	V+ to V-
Digital Input	V- to DGND
Power Dissipation, Flat Package	500mW
Operating Temperature	0°C to 70°C
Storage Temperature	-25°C to 125°C

Electrical Characteristics

TA=25°C, V- = -3V

Symbol	Parameter	Test Condition	Min.	Typ.	Max.	unit
V-	Power Supply		-3.5	-3.0	-2.2	V
I _{dd}	Operating Supply Current	Normal Power On	-	1.3	2.0	mA
I _{ss}		Auto-power-off	-	5	10	uA
REV	Rollover Error (Voltage x 1)	1M input Resistor	-	-	± 0.1	% F.S.
REB	Rollover Error (Bargraph)		-	-	± 0.5	% F.S.
NLV	Nonlinearity (Voltage x 1)	Best Case	-	-	± 0.1	% F.S.
NLB	Nonlinearity (Bargraph)	Straight Line	-	-	± 0.5	% F.S.
	Input Leakage		-	1	10	pA
	Internal Low Battery Flag Voltage (for 3V battery)	V- to AGND	-2.5	-2.3	-2.1	V
	Zero Input Reading	1MΩ Input Resistor	-000	000	+000	count
V12	Reference Voltage	100KΩ Between V12 and AGND	-1.3	-1.2	-1.1	V
V05	Reference Voltage	100KΩ Between V05 and AGND	-0.57	-0.50	-0.43	V
	LCD Drive Voltage, ANNUNC	-3.5 ≤ V- ≤ -2.2	2.9	3.2	3.5	V
	Counter Time Base Period	fosc=4MHz	-	1	-	Sec
	Internal Pull High to 0V Current	BKLIT,RANGE,SET, DP1,DP2,BDIS, BUZIN,XTAL,RESET, FC1,FC2,FC3,M2, M10,D10,ZOOM, PEAK,REL,MAX/MIN HOLD (which is connected to V-)	-	1.2	-	uA

Electrical Characteristics (cont.)

TCRF	Reference Voltage Temperature Coefficient	100K Ω Between V12 and AGND 0°C < TA < 70°C	-	50	-	ppm/ °C
	Buzzer frequency	Fosc = 4M HZ		2.5		KHZ
	LCD drive frequency			78		HZ
V _L L	Logic low reference voltage	Logic test DC		0.8		V
V _L H1 V _L H2 V _L H3	Logic high reference voltage	Logic test DC		4.0 2.4 1.5		V V V
	Maximum and minimum peak value accuracy (10 uS)	使用 10nF 聚乙酯薄膜 電容(polyester, Mylar)		±2% ±10		F.S. count

Pin Description

Pin	Symbol	Type	Description
1	AGND	G	Analog ground.
2	AGND	G	Analog ground.
3	V+	P	Positive supply voltage, output of on-chip DC-DC converter.
4	V+	P	Positive supply voltage, output of on-chip DC-DC converter.
5	ZH	O	Output to RC filter for ZOOM mode
6	ZL	I	Input from RC filter for ZOOM mode
7	CH+	I/O	High speed positive connection for reference capacitor.
8	CH-	I/O	High speed negative connection for reference capacitor.
9	CIH	O	High speed integrator output. Connected to integration capacitor.
10	BUFHD10	O	Integration resistor (1 M Ω) connection for high speed buffer $\div 10$ output.
11	BUFH	O	Integration resistor (100 k Ω) connection for high speed buffer output.
12	BUFHM10	O	Integration resistor (10 k Ω) connection for high speed buffer $\times 10$ output.
13	CAZH	O	High speed auto-zero capacitor connection
14	CL+	I/O	High resolution positive connection for reference capacitor.
15	CL-	I/O	High resolution negative connection for reference capacitor.
16	CIL	O	High resolution integrator output. Connected to integration capacitor.
17	CAZL	O	High resolution auto-zero capacitor connection.
18	BUFLD10	O	Integration resistor (1 M Ω) connection for high resolution buffer $\div 10$ output.
19	BUFL	O	Integration resistor (100 k Ω) connection for high resolution buffer output.
20	BUFLM10	O	Integration resistor (10 k Ω) connection for high resolution buffer $\times 10$ output.

Pin	Symbol	Type	Description
21	V05	O	Reference voltage output -0.5V to AGND for resistor measurement.
22	V12	O	Reference voltage output -1.2V to AGND.
23	REFLO	I	Low differential reference input connection
24	REFHI	I	High differential reference input connection
25	VIN+	I	High analog input signal connection.
26	VIN-	I	Low analog input signal connection.
27	P _{MAX}	I/O	Maximum peak hold output.
28	P _{MIN}	I/O	Minimum peak hold output.
29	OP+	I	OP + terminal input.
30	OP-	I	OP - terminal input.
31	OPO	O	OP output. If this OP is not used, let OPO saturate to V+ can save power. For example, let OP+=0V and OP-=-3V.
32	OR	O	Overrange output. It could be controlled by RANGE pin.
33	PKIN	I	PEAK HOLD (v.s. AGND) or Logic Probe (v.s. V-) input pin .
34	BKLIT	I	Back light control pin. Pulse low to make this function active.
35	SLEEP	O	When auto-power-off happen, this pin output will change from V+ to V-. If re-power-on happen, the output will change from V- to V+.
36	INT	O	Integration cycle output (100 ms).
37	RANGE	I	Semiauto/manual mode and manual range selecting. Pulse low to make this function active.
38	SET	I	Input to set serial data output. Pulse low to make this function active.
39	MP	I	Ranges setting for MAX/MIN or PEAK mode.
40	DP1	I	Decimal point control for voltage measurements.
41	DP2	I	Decimal point control for voltage measurements.
42	FREQ	I	Frequency counter input, biased to 1/2 V- by IC internal circuit.
43	BDIS	I	When connected to V-, bargraph will be disabled (voltage mode).
44	ANNUNC	O	Square-wave output at the backplane frequency, synchronized to BP1. ANNUNC can be used to control display annunciator. Connecting a LCD segment to ANNUNC will turn it on; connecting a LCD segment to its backplane will turn it off.
45	SEG23	O	LCD Segment line 23.
67	SEG01	O	LCD Segment line 01.
68	BP1	O	LCD Backplane 1.
69	BP2	O	LCD Backplane 2.
70	BP3	O	LCD Backplane 3.
71	BP4	O	LCD Backplane 4.
72	PH1	O	Phase1 output, for capacitor measurement.
73	PH2	O	Phase2 output, for capacitor measurement.
74	PH3	O	Phase3 output, for capacitor measurement.
75	PH4	O	Phase4 output, for capacitor measurement.
76	BUZOUT	O	Buzzer output. Audio frequency (2.5 KHz) output which drives a piezoelectric buzzer.

Pin	Symbol	Type	Description
77	BUZIN	I	Buzzer control input. When connected to V-, turns the buzzer on. (2.5 KHz continuity signal)
78	OSC2	O	Crystal oscillator (output) connection.
79	OSC1	I	Crystal oscillator (input) connection.
80	XTAL	I	When unconnected or connected to DGND, the oscillator frequency is generated by external crystal. When connected to V-, the frequency is decided by internal RC oscillator.
81	RESET	I	Pulse low to clear the push function and counter.
82	FC1	I	Switch 1 for function selection.
83	FC2	I	Switch 2 for function selection.
84	FC3	I	Switch 3 for function selection.
85	M2	I	When connected to V-, the integration full voltage will be 200mV instead of 400mV.
86	M10	I	When connected to V-, the integration full voltage will be 40mV instead of 400mV.
87	D10	I	When connected to V-, the integration full voltage will be 4V instead of 400mV, and the absolute value of input voltage must $\leq 2V$.
88	ZOOM	I	Zoom function select and Logic function setting (buzzer on state).
89	PEAK	I	Peak hold control pin, pulse low can make this function active.
90	REL	I	Relative control pin. Pulse low to make this function active.
91	MAX/MIN	I	Pulse low to make this function active.
92	HOLD	I	Pulse low to make this function active.
93	BKOUT	O	If BKLIT pin is pushed, this pin output will change from V- to V+ for 60 sec then returned to V- again, the driving current is about 1 mA.
94	SDO	O	RS232 output pin.
95	C+	O	Positive capacitor connection for on-chip DC-DC converter.
96	C-	O	Negative capacitor connection for on-chip DC-DC converter.
97	LBAT9	I	Low battery voltage setting. If used 3V battery, connected this pin to AGND, the default low battery voltage will be -2.3V. For 9V battery power, if this pin input is smaller than V12 (-1.2V), the LCD annunciator "BATT" will be displayed.
98	V-	P	Negative supply voltage. Connecting to battery negative terminal.
99	V-	P	Negative supply voltage. Connecting to battery negative terminal.
100	DGND	G	Digital ground, connected to battery positive terminal.

*Type: I=Input, O=Output, P=Power, G=Ground

Pin Configuration

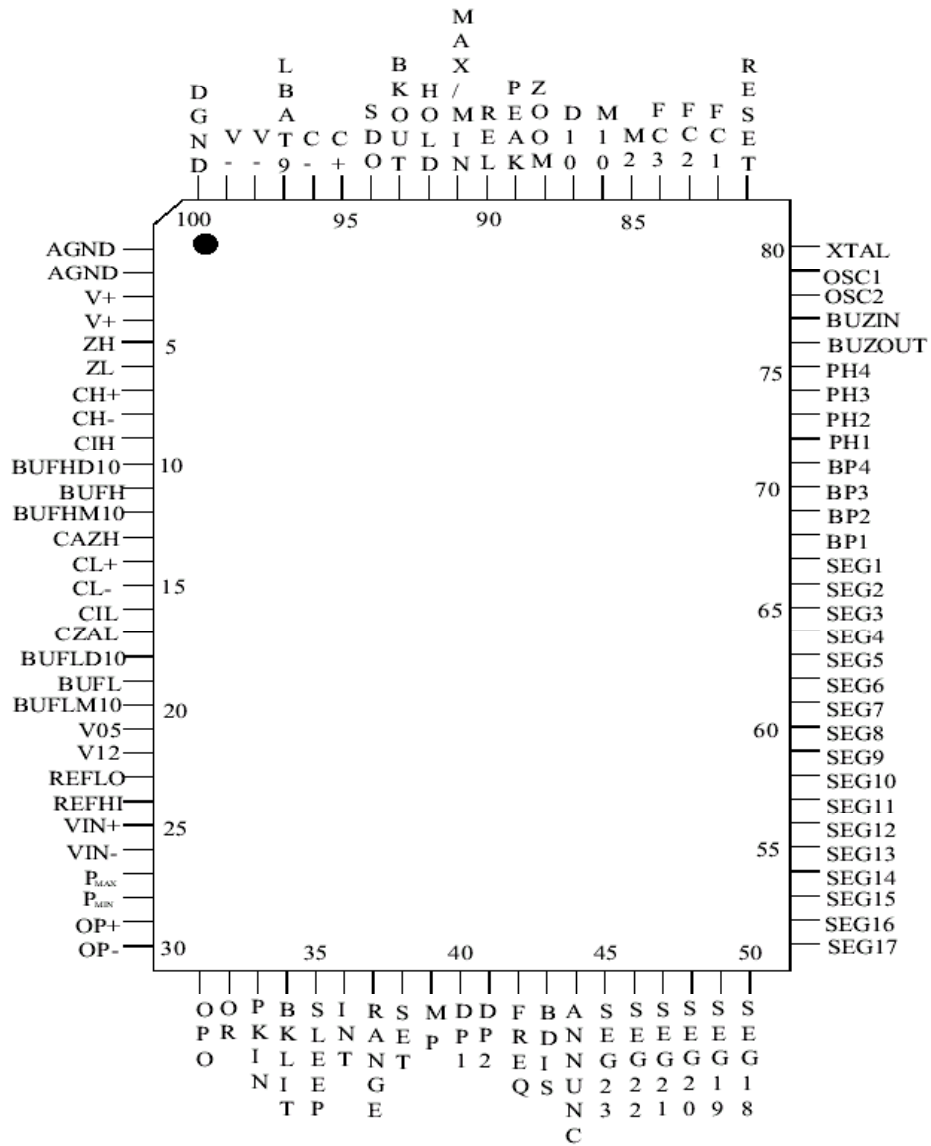

Operation Mode

Switch Description

Measurement mode are depend on the logic levels of FC1, FC2, FC3.

FC1	FC2	FC3	Mode	Overflow Beep	PEAK	ZOOM	BDIS
1	1	1	Volt1 (*1)	O	O	O	O
1	1	0	Volt2	O	X	O	O
1	0	1	Volt3	X	O	O	O
1	0	0	Volt4	X	(*2)	O	O
0	1	1	Continuity	X	X	X	X
0	1	0	Frequency (*3)	X	X	X	X
0	0	0	Logic (*4)	X	X	(*5)	X
0	0	1	Diode	X	X	X	X

*1: The LCD will show "OL" if reading is over 2000 counts if turns D10 function on.

*2: If PEAK connects to V-, the sign annunciator "-" will not display.

*3: The range can be changed by RANGE pin.

*4: The logic high level reference voltage level can be changed by RANGE pin.

*5: This pin is used to change the voltage level of buzzer on.

Analog Section

The ES51961 design incorporates "ZI", "AZ", "INT", "DINT" four phases which is a dual slope A/D converter. The ADC system including high speed and high resolution two parts. Its timing setting is as follow:

Voltage:

Mode	High Resolution	High Speed
ZI	100m sec	20m sec
AZ	150m sec	5m sec
INT	100m sec	10m sec
DINT	400m sec	40m sec

Voltage+M2:

Mode	High Resolution	High Speed
ZI	100m sec	20m sec
AZ	150m sec	5m sec
INT	100m sec	10m sec
DINT	200m sec	20m sec

Voltage+PEAK:

Mode	High Resolution	High Speed
ZI	100m sec	20m sec
AZ	150m sec	5m sec
INT	100m sec	10m sec
DINT	500m sec	50m sec

Voltage+PEAK+M2:

Mode	High Resolution	High Speed
ZI	100m sec	20m sec
AZ	150m sec	5m sec
INT	100m sec	10m sec
DINT	250m sec	25m sec

The relation between the scale range and Bar meaning

Scale	Enabled pin	Input full range	Normal mode Bar meaning	Zoom mode Bar meaning
×1	Default or M10 & D10	400mV	10mV	1mV
×10	M10	40mV	1mV	1mV
×2	M2	200mV	5mV	0.5mV
×20	M10 & M2	20mV	0.5mV	0.5mV
÷ 10	D10	4000mV	100mV	10mV
÷ 5	D10 & M2	2000mV	50mV	5mV

* If M2, M10, D10 is changed under MP="H", the original enabled function (ex: HOLD, MAX/MIN, REL, PEAK) and the input data will be reset, but the OR output will not be changed. On the contrary, when MP="L", see the explication of MP and OR at page 15 please.

* When M2, M10, or D10 is changed, we must recalibrate if we will use PEAK function again.

LOGIC Probe

(1) Logic State & High Voltage Level & Buzzer on Level

There are three kind of independent LOGIC high level, 4.0V, 2.4V and 1.5V (changed by RANGE pin), and buzzer on "H", "-" and "L" level (changed by ZOOM pin) can be selected individually. The Logic low level is always 0.8V and the response frequency is 20MHz.

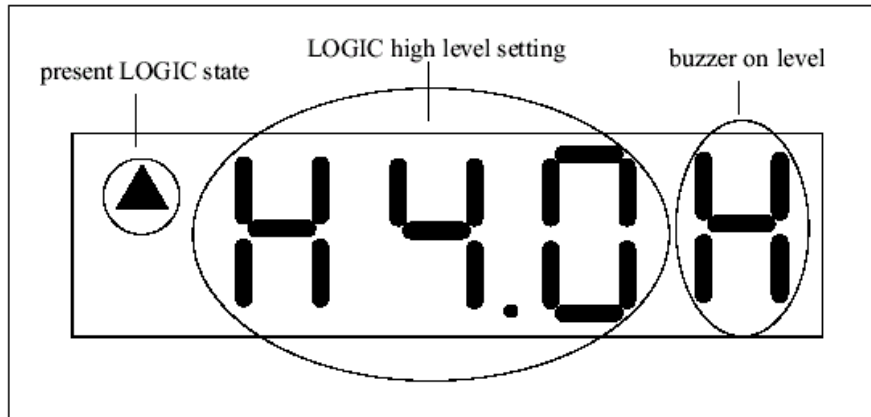

The default LOGIC mode panel

LOGIC probe input high should connect to PKIN pin, the LOGIC probe input low should connect to V- pin (not VIN- pin), so the maximum voltage difference between LOGIC high & low can be 6V.

Example:

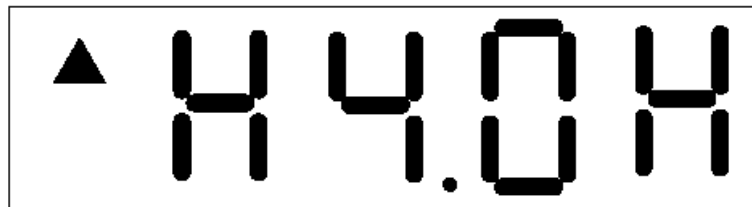

The above panel means now is logic high (the input > 4.0V) and the buzzer turn on.

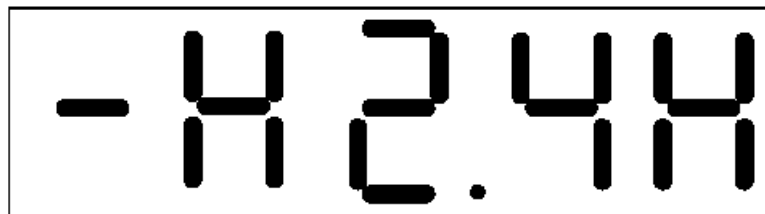

The above panel means now is logic unknown (the input between 0.8V~2.4V) and once the LOGIC level change to high (>2.4V), the buzzer will turn on.

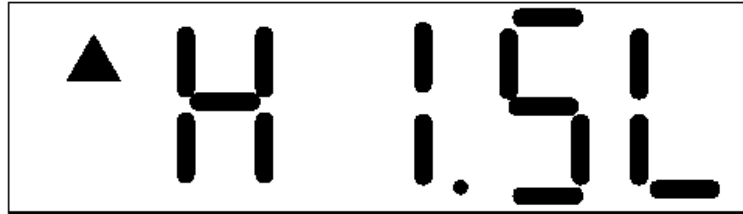

The above panel means now is logic high (the input $> 1.5V$) and once the LOGIC level change to low ($< 0.8V$), the buzzer will turn on .

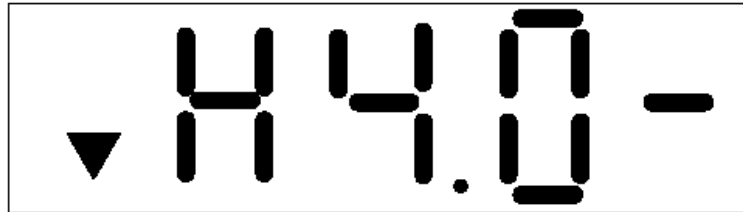

The above panel means now is logic low (the input $< 0.8V$) and once the LOGIC level change to unknown ($0.8V \sim 4.0V$), the buzzer will turn on .

(2) The relation between the input and LCD annunciator

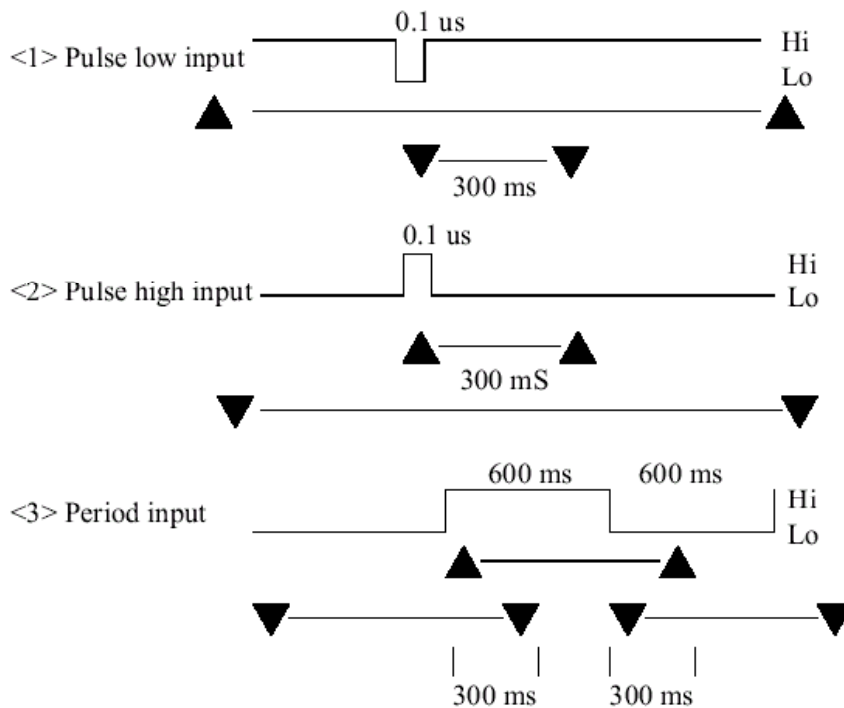

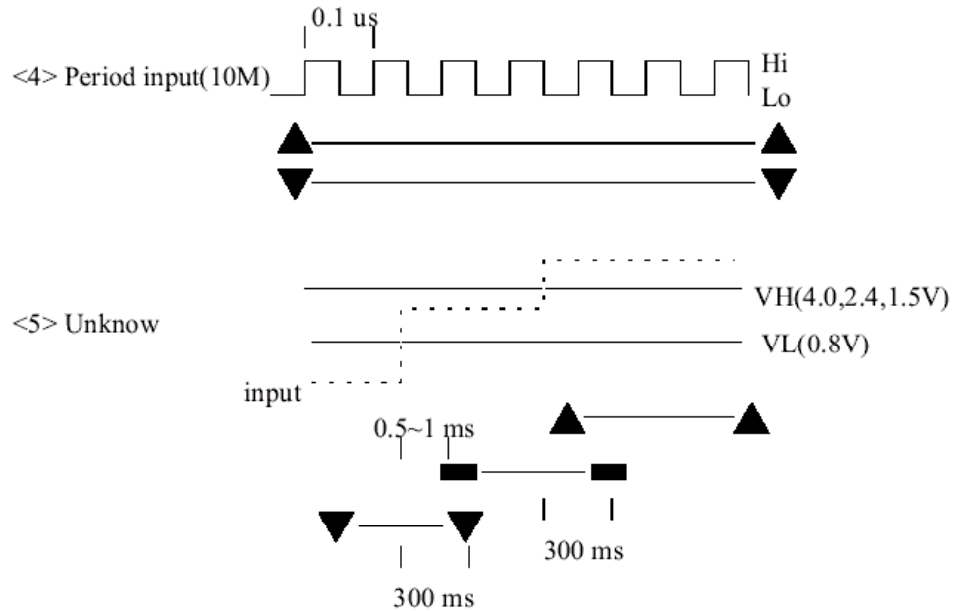

Frequency Counter

The timebase of ES51961 is derived by a crystal or internal RC clock oscillator. The timebase of counter is :

$$T_{\text{count}} = \frac{f_{\text{osc}}}{4,000,000}$$

Thus, the counter will operate with a 1 second timebase when a 4MHz crystal oscillator is used. For accurate frequency measurement, a crystal oscillator is recommended. The frequency counter can automatically select the proper range. Autorange operation extends over five decades from 1 Hz to 399.9 MHz.

Range	Full Scale
FR1	3.999 KHZ
FR2	39.99 KHZ
FR3	399.9 KHZ
FR4	3.999 MHZ
FR5	39.99 MHZ
FR6	399.9 MHZ

Continuity

If the input voltage (VIN+~VIN-) make the bargraph number ≤ 3 , a 2.5 KHz signal will come out from BUZOUT pin.

Diode

If the input voltage (VIN+~VIN-) high resolution counts ≥ 2000 , the LCD will display "OL" and no overflow beep exist. If the bargraph number ≤ 3 , a 2.5 KHz signal will come out from BUZOUT pin.

Push mode

The relation between HOLD, MAX/MIN, REL, PEAK function.

enable mode active mode	HOLD	PEAK	MAX/MIN	REL
(1)HOLD		X	X	X
(2)PEAK	O		X	X
(3)MAX/MIN	O	X		X
(4)REL	O	X	X	

- *1: If HOLD function is enabled, then MAX/MIN, REL, PEAK function is disabled.
- *2: If PEAK function is enaled, then REL, MAX/MIN function is disabled, but HOLD function still can be activated.
- *3: If MAX/MIN function is enaled, then REL, PEAK function is disabled, but HOLD function still can be activated.
- *4: If REL function is enaled, then PEAK, MAX/MIN function is disabled, but HOLD function still can be activated

(1) HOLD and RESET:

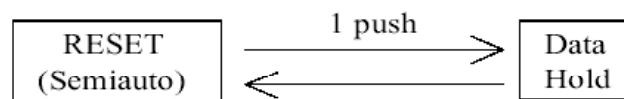

- *1: If continue to press the HOLD pin (logic low) then power on the ES51961, and release it in 1.2 sec, the all segments will bright until pressing the HOLD pin again.
- *2: Every time this RESET pin pulse to low (0.8~1.6ms), the pushed function (HOLD, MAX/MIN, REL, PEAK, ZOOM except BKLIT), auto-power-off function and counter will be reset.

(2) REL+HOLD:

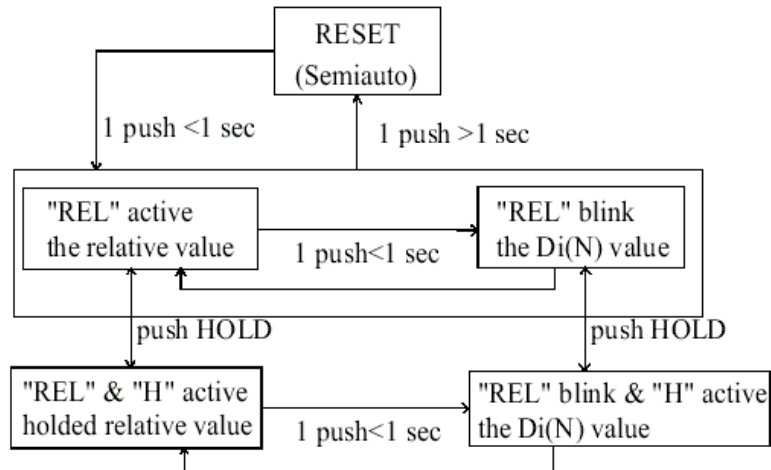

Note: 1. When REL function is enabled:

$$\text{Display} = \text{Di}(N+K) - \text{Di}(N), K = 0, 1, 2, 3, \dots$$

Di(N): the reference

Di(N+K): next K step input reading.

2. If the input value Di(N) or Di(N+K) $\geq (\pm 4000)$, the relative value will display "OL".

(3) MAX/MIN+HOLD:

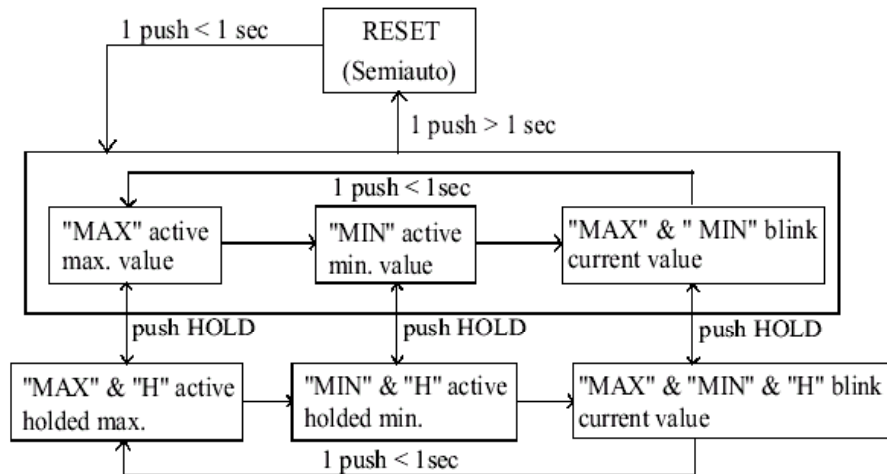

(4) PEAK:

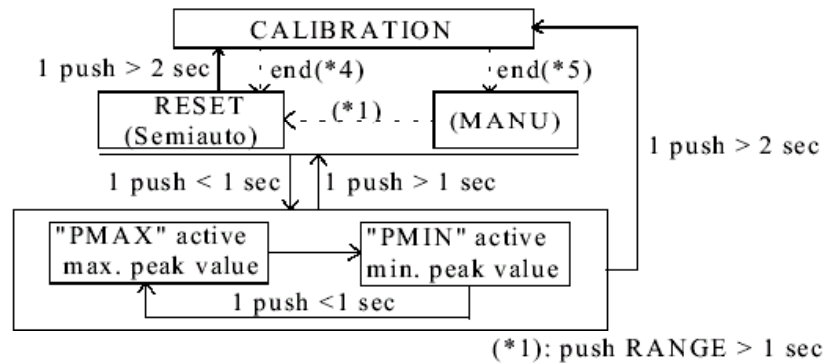

- *2: Under the RESET (semiauto) or PEAK mode, if press PEAK > 2 sec, the PEAK function will enter to calibration mode, the LCD will show "CAL." and the internal buffer will remember the internal OP offset voltage then back to the manual mode. Whenever the PEAK function is enabled again, the reading value will minus the offset voltage, the purpose is to get the real peak reading.
- *3: Under PEAK mode, the bargraph always show current value.
- *4, *5: Please see page 16 note 3.

(5) RANGE:

The ranges of voltage, frequency and logic modes is selected by RANGE pin. The following are the operation flow chart of them.

Voltage mode:

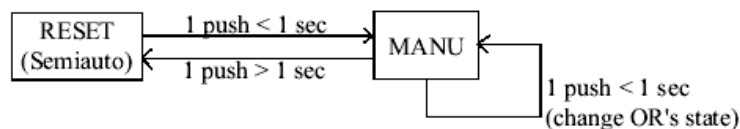

Frequency mode:

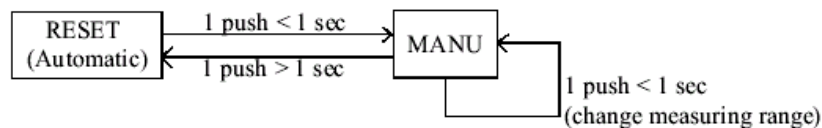

Logic mode:

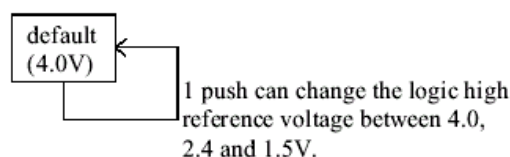

MP

The default state is H (0V). When MP="H", if turn MAX/MIN or PEAK on, OR and range keep original state. If MP="L", whether the original state of OR is "H" or "L", if active MAX/MIN or PEAK, the OR's state will be set to "H".

OR

This pin is used to set/indicate the measured ranges.

The criterion of OR pin changing are:

- (1) if under continuity, frequency, logic or diode mode, the OR is always L.
- (2) under volt1~volt4 mode and MP="L", if MAX/MIN or PEAK active, the OR="H".
- (3) except situation (1), (2) (i.e. volt1~volt4 mode and MP="H"), if turning HOLD, MAX/MIN, REL, PEAK on, the system will enter into manual mode and OR keep its original state.
- (4) except situation (1)~(3), under semiauto mode, if (FC1,FC2,FC3)=(1,1,1) and D10 on, then
 - (i) OR→"H", if high resolution ≥ 2000 counts
 - (ii) OR keeps its original state, if $380 \leq$ high resolution < 2000 counts
 - (iii) OR→"L", if high resolution < 380 counts
- (5) except situation (1)~(4), under semiauto mode the state of OR is:
 - (i) OR→"H", if high resolution ≥ 4000 counts
 - (ii) OR keeps its original state, if $380 \leq$ high resolution < 4000 counts
 - (iii) OR→"L", if high resolution < 380 counts

Note:

1. There are several situations between MP and OR pins. As follow:
 - (1) MP="H": The state of OR pin can be set by RANGE pin. And if we push MAX/MIN or PEAK key under semiauto mode, the meter will enter into manual mode and the OR pin keeps its original state.
 - (2) MP="L": The state of OR pin can be still set by RANGE pin. But if we push MAX/MIN or PEAK key under semiauto or manual mode, the OR pin will change to "H".

2. Besides, if we have already turned MAX/MIN or PEAK function on, the relationship between MP and OR can restate:
 - (1) MP="H": If the states of M2, M10 or D10 are changed by OR or rotating mode , then MAX/MIN or PEAK function will be reset. Though the state of OR pin isn't changed again , it can be changed by RANGE pin.
 - (2) MP="L": If the states of M2, M10 or D10 are changed by OR's state, the MAX/MIN or PEAK function keep in its original state.
3. Under PEAK calibration mode,
 - (1) MP="H": When calibration is end, the meter will back to manual mode
 - (2) MP="L": When calibration is end, the meter will back to its original mode (manual or semiauto) before the function happen.
4. Whatever MP = "H" or "L", the HOLD, REL, MAX/MIN or PEAK complete, the meter will back to the original mode (manual or semiauto) before these functions happen.

ZOOM

(1) Voltage mode

The default status of the bargraph display is from left to right. Once this function is pushed, the bargraph display will change to ZOOM mode.

(2) Logic mode

This pin is used to turn on the buzzer whether is under High, Low or unknown Logic (the default is High beep).

BKLIT

When this pin BKLIT is pushed, the BKOUT pin output will change from V- to V+ for 60 sec then returned to V- again, but if this pin is pushed again under 60 sec this function will be canceled

Decimal point select (Under voltage mode)

DP2	DP1	Decimal point
H	H	None
H	L	Point1
L	H	Point2
L	L	Point3

Auto-Power-Off function

Once power on the ES51961, the auto-power-off function will be enabled and if the functions are not changed in 30 minutes, the auto-power-off condition will be happened. When power-off happens, the final data is saved. If continue to push anyone of the push function (except HOLD pin) then power on the ES51961, the auto-power-off function will be disabled, and LCD segment "APO" will be turn off.

Re-Power-On

Once auto-power-off happens, push anyone of the push function or change the rotary mode can re-power-on the ES51961. When anyone of the push function is enabled, the storage value will display with HOLD mold (except logic state), if auto-power-off happened under MAX/MIN (or PEAK, REL) mode, the P_{MAX} , P_{MIN} , or relative and reference value will be kept. But if re-power-on the ES51961 with rotary mode, the storage value will be clear.

SLEEP

When auto-power-off happens, this pin output will change from V+ to V-, once re-power on happen, this pin output will change from V- to V+.

Buzzer

(1) The BUZZER turns on in the following condition :

- 1 beep: Measurement function changed ,power and re-power on ,HOLD MAX/MIN, REL, PEAK, BKLIT, SET, RANGE or ZOOM are

pushed.

- 3.3 beeps: Input reading overrange.
- 2.5 KHZ continue: Continuity mode, Diode mode, Logic mode.

(2) BUZZER output waveform:

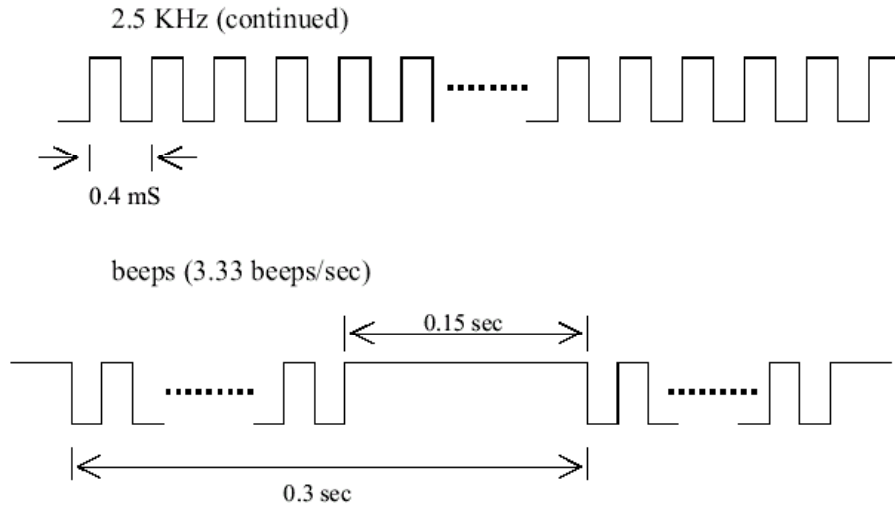

Serial Data Output

The serial data is output two times from SDO pin on each A/D conversion cycle. The data format satisfy JIS 7BIT transmission code and the baud rate is 2400, it means the receiver terminal can use RS-232 interface to read data.

single package



A single package include a start bit (0), D0~D6 (7 bit), a parity check bit (odd) and a stop bit (1). All the data stream is consist of 100×2 bits.

All package



(3) FUNCTION:

FUNCTION1:

0	1	1	—	FC1	FC2	FC3
BIT7	BIT6	BIT5	BIT4	BIT3	BIT2	BIT1

—: "1" is for the negative (-).

FUNCTION2:

0	1	1	MANU	M2	M10	D10
BIT7	BIT6	BIT5	BIT4	BIT3	BIT2	BIT1

MANU: "1" is on "⊕" mode, and "0" is on "AUTO" .

(4) STATUS:

STATUS1:

0	1	1	P _{MAX}	P _{MIN}	BATT	OL
BIT7	BIT6	BIT5	BIT4	BIT3	BIT2	BIT1

BATT: "1" is for the battery voltage is less than $2.3V \pm 0.2V$.

OL: "1" is for the input overrange.

STATUS2:

0	1	1	P2	P1	APO	OR
BIT7	BIT6	BIT5	BIT4	BIT3	BIT2	BIT1

APO: "1" is for the auto-power-off function enabled

OR: "1" means the voltage of OR pin is V+.

Note: 1. Under Diode mode, if reading is ≥ 2000 counts, LCD show "OL".

2. Under Volt1 (ie (FC1, FC2, FC3)=(1, 1, 1)) & D10 mode, if reading is ≥ 2000 counts, LCD show "OL".

3. When the offset voltage of PEAK mode is ≥ 1000 counts, LCD show "OL".

4. except condition 1., 2. and 3., if input reading is ≥ 4000 counts, LCD show "OL".

P2	P1	Decimal point
0	0	None
0	1	Point1
1	0	Point2
1	1	Point3

(5) CR (BACK): Transmission code "0001101".

(6) LF (LINE FEED): Transmission code "0001010".

7. Test Circuit

(1) DC test

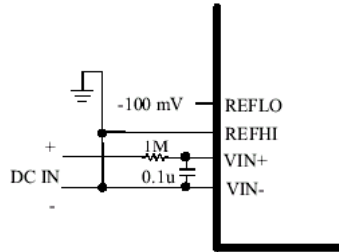

(2) FREQ input test

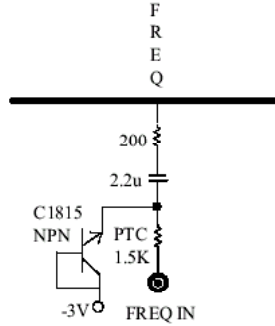

(3) AC test

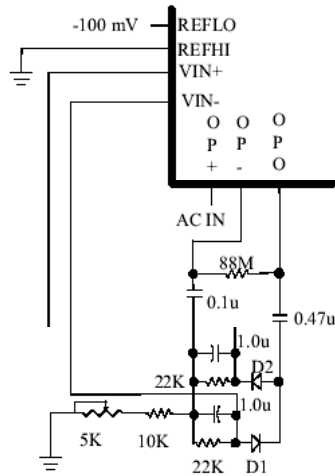

(4) Peak function test

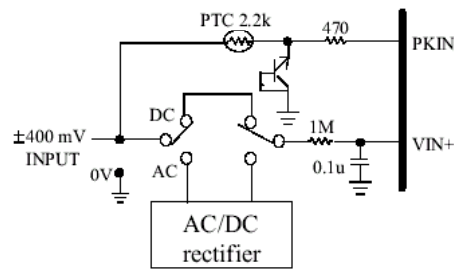

Under voltage mode, if Peak function is enabled, PKIN input will be enabled

(5) LOGIC test

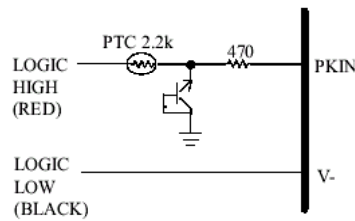

(6) Low battery test(9V)

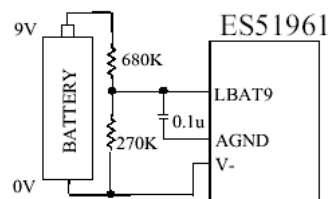

Note: Light shielding for diode.

8. Application Circuit

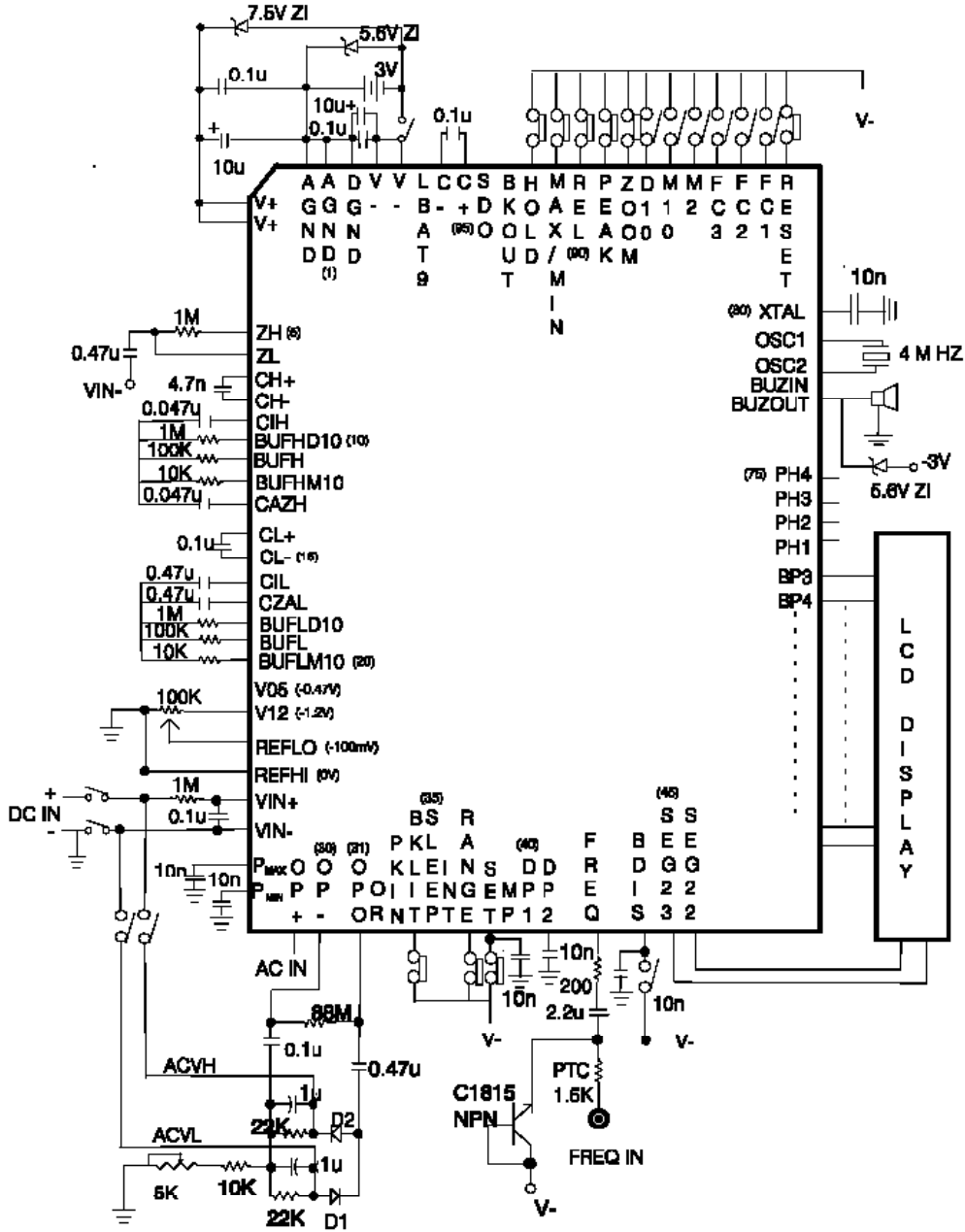



9. The Other

(1) LCD pin assignment

	BP1	BP2	BP3	BP4	SEG1	SEG2	SEG3
BP4					APO	▲	-
BP3					Bar0	Bar-	▼
BP2					Bar1	Bar3	Bar5
BP1					Bar2	Bar4	Bar6

	SEG4	SEG5	SEG6	SEG7	SEG8	SEG9	SEG10
BP4	REL	4F	4A	4B	MAX	3F	3A
BP3	BATT	4E	4G	4C	DP3	3E	3G
BP2	Bar7	Bar9	4D	Bar12	Bar14	Bar16	3D
BP1	Bar8	Bar10	Bar11	Bar13	Bar15	Bar17	Bar18

	SEG11	SEG12	SEG13	SEG14	SEG15	SEG16	SEG17
BP4	3B	MIN	P_{MAX}	2F	2A	2B	P_{MIN}
BP3	3C	ZOOM	DP2	2E	2G	2C	
BP2	Bar19	Bar21	Bar23	Bar25	2D	Bar28	Bar30
BP1	Bar20	Bar22	Bar24	Bar26	Bar27	Bar29	Bar31

	SEG18	SEG19	SEG20	SEG21	SEG22	SEG23
BP4	HOLD	1F	1A	1B	KHZ	
BP3	DP1	1E	1G	1C	MHZ	Y
BP2	Bar32	Bar34	1D	Bar37	Bar39	X
BP1	Bar33	Bar35	Bar36	Bar38	Bar40	

NOTE:

X: always on.

Y: if bargraph is under normal mode (except ZOOM mode), the position is on for (0, 10, 20, 30, 40).

ZOOM: if bargraph is under zoom mode, the position is on for (-20, -10, 0, 10, 20).

"▲": Logic high.

"▼": Logic low.

"": manual mode.

Example for digits under bargraph:

Case1:

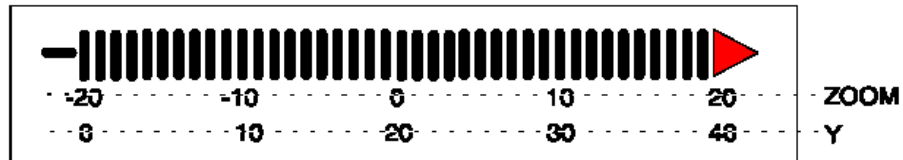

Case2:

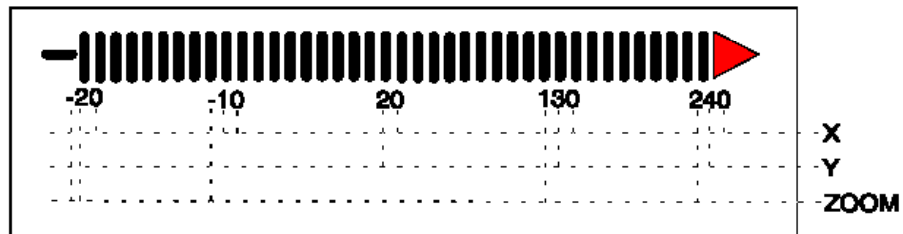

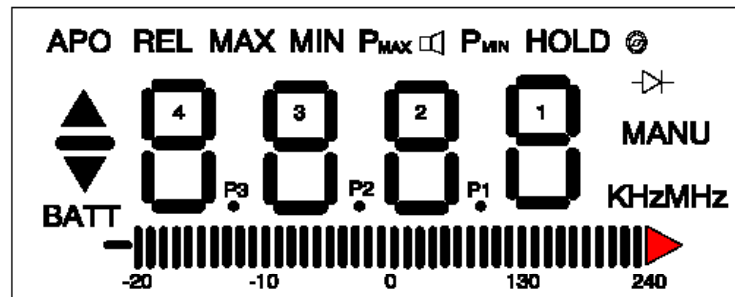

Example for LCD panel:

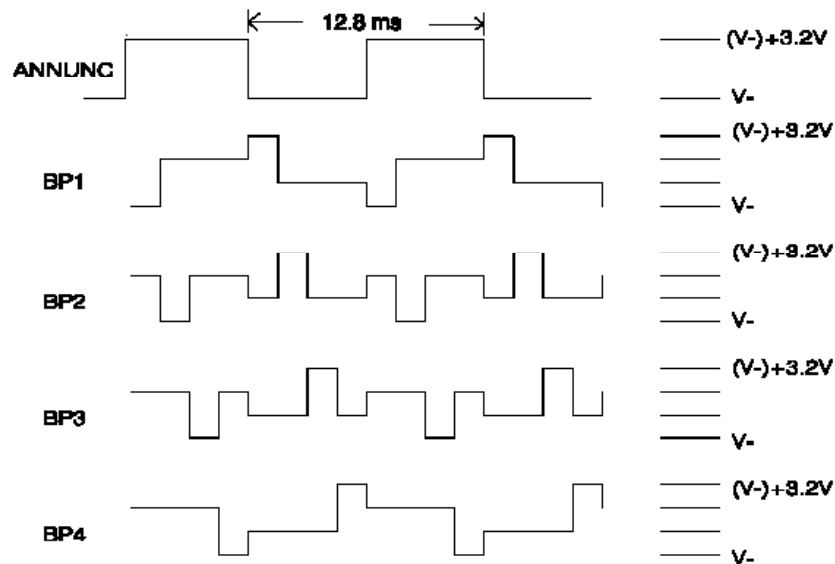

(2) Backplane Waveform (Frequency = 78 Hz)



(3) LCD Display ON Condition

LCD Annunciator	Condition
"BATT"	Low battery is detected.
"▲"	Logic high function
"▼"	Logic low function
"-"	DC voltage and current function and Logic unknown mode.
"P _{MAX} "	Maximum peak function is used.
"P _{MIN} "	Minimum peak function is used.
"REL"	REL function is used.
"HOLD"	HOLD function is used.
"MAX"	MAX function is used.
"MIN"	MIN function is used.
" 	Continuity-check and Diode-check are used.
" 	Diode-check is used.
" 	Frequency manual mode or completing a calibration on PEAK mode are used.
"KHz"	Frequency counter is used.
"MHz"	Frequency counter is used.
"APO"	Auto-power-off function is used.
Bargraph	Bargraph annunciator is only depend on input reading .
" -20, -10, 0, 10, 20"	ZOOM function is used.

(4) PH1, PH2, PH3, PH4 four phase output

