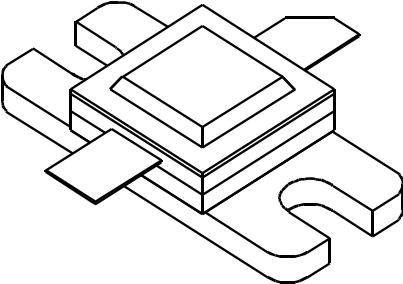

<p><b>GENERAL DESCRIPTION</b> The 1214-30 is an internally matched, COMMON BASE transistor capable of providing 30 Watts of pulsed RF output power at two milliseconds pulse width, twenty percent duty factor across the band 1200 to 1400 MHz. This hermetically solder-sealed transistor is specifically designed for long pulse radar applications. It utilizes gold metalization and diffused emitter ballasting to provide high reliability and supreme ruggedness.</p>	<p><b>CASE OUTLINE</b> <b>55AW, STYLE 1</b></p> 
<p><b>ABSOLUTE MAXIMUM RATINGS</b> Maximum Power Dissipation @ 25°C 88 Watts</p> <p><b>Maximum Voltage and Current</b> BVces Collector to Emitter Voltage 50 Volts BVebo Emitter to Base Voltage 3.5 Volts Ic Collector Current 4.0 Amps</p> <p><b>Maximum Temperatures</b> Storage Temperature - 65 to + 200°C Operating Junction Temperature + 200°C</p>	

**ELECTRICAL CHARACTERISTICS @ 25 °C**

SYMBOL	CHARACTERISTICS	TEST CONDITIONS	MIN	TYP	MAX	UNITS
<b>Pout</b>	Power Out	F = 1200-1400 MHz	30			Watts
<b>Pin</b>	Power Input	Vcc = 28 Volts			6.0	Watts
<b>Pg</b>	Power Gain	Pulse Width = 2 ms	7.0			dB
<b>ηc</b>	Collector Efficiency	Duty = 20%		48		%
<b>VSWR</b>	Load Mismatch Tolerance	Rated Conditions			3:1	

<b>BVces</b>	Collector to Emitter Breakdown	Ic = 50 mA	50			Volts
<b>BVebo</b>	Emitter to Base Breakdown	Ie = 5 mA	3.5			Volts
<b>Hfe</b>	DC Current Gain	Vce=5 V, Ic =500mA	20			
<b>Cob</b>	Output Capacitance*	F=1 MHz, Vcb=28V				pF
<b>θjc</b>	Thermal Resistance	Rated Pulse Condition			2.0	°C/W

\* Not measureable due to internal prematch network

IssueA July 1997

GHz TECHNOLOGY INC. RESERVES THE RIGHT TO MAKE CHANGES WITHOUT FURTHER NOTICE. GHz RECOMMENDS THAT BEFORE THE PRODUCT(S) DESCRIBED HEREIN ARE WRITTEN INTO SPECIFICATIONS, OR USED IN CRITICAL APPLICATIONS, THAT THE PERFORMANCE CHARACTERISTICS BE VERIFIED BY CONTACTING THE FACTORY.

GHz Technology Inc. 3000 Oakmead Village Drive, Santa Clara, CA 95051-0808 Tel. 408 / 986-8031 Fax 408 / 986-8120

**POWER OUTPUT vs POWER INPUT**

Vcc = 28 V, PW = 2 ms, Duty = 20%

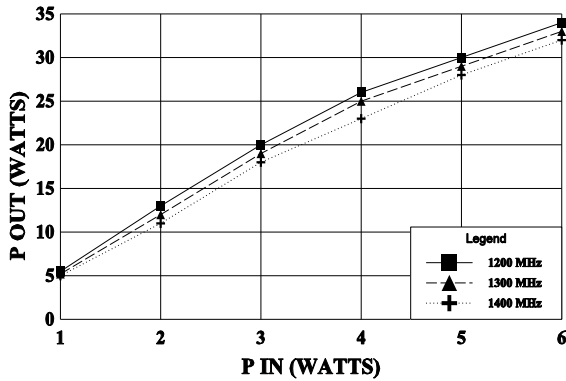

**POWER OUPUT AND EFF. vs FREQUENCY**

Vcc = 28 V, Pin = 6 W, 2 ms, 20%

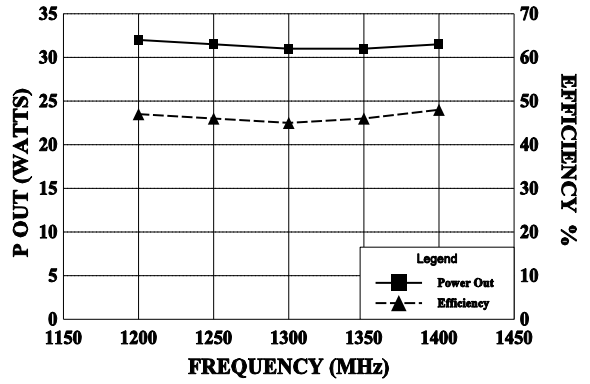

**Typical Impedances**

**INPUT IMPEDANCE vs FREQUENCY**

Zin = R + jX (Vcc = 28 V, Pin = 6 W)

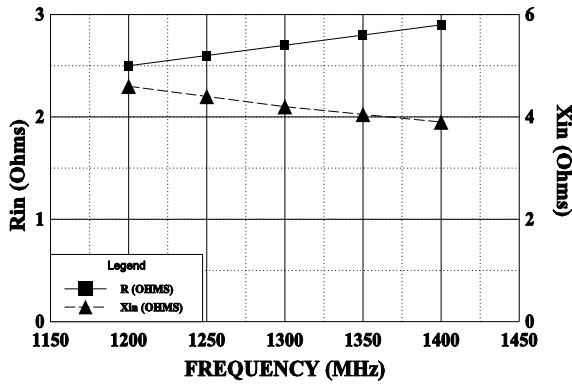

**LOAD IMPEDANCE vs FREQUENCY**

Zcl = Rcl - jXcl (Vcc = 28 V, Pin = 6 W)

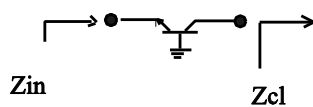
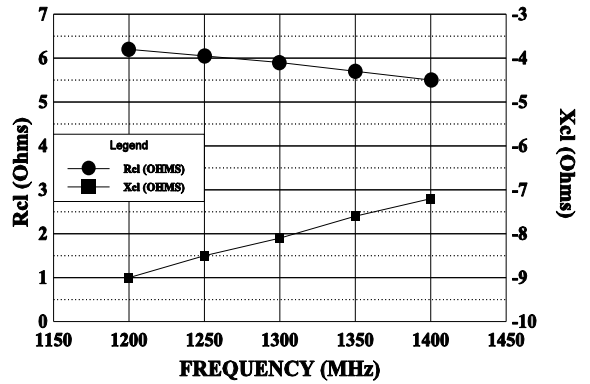

REVISIONS

ZONE	REV	DESCRIPTION	DATE	APPROVED
------	-----	-------------	------	----------

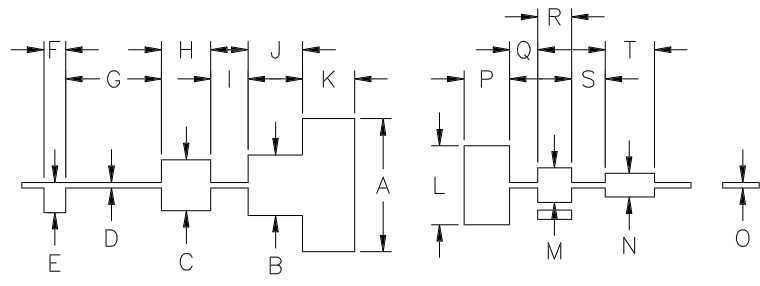

DIM	INCHES
A	.730
B	.332
C	.280
D	.030
E	.165
F	.120
G	.525
H	.270
I	.205
J	.300
K	.285
L	.433
M	.190
N	.130
O	.030
P	.250
Q	.155
R	.185
S	.185
T	.270

1214-30 TEST CIRCUIT

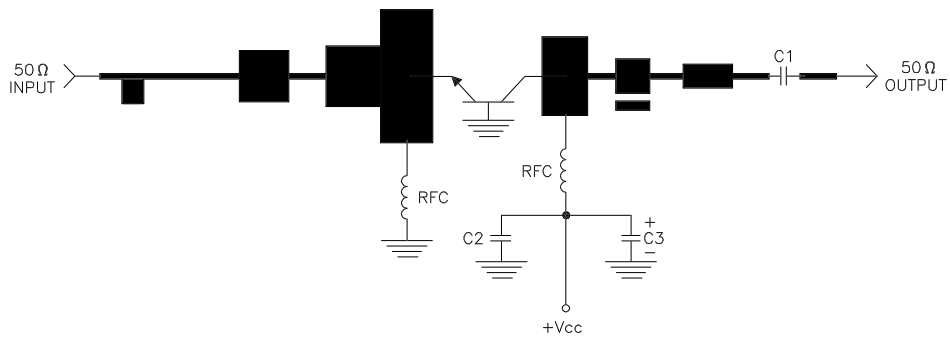

DIELECTRIC = 10 MIL THICK  
 DUROID, Er = 2.3  
 C1, C2 = 82pF CHIP ATC "A"  
 C3 = 100MFD @ 35V  
 RFC = 5 turns #22 wire 1/16" I.D.



CAGE OPJR2	DWG NO. 1214-30	REV A
	SCALE 1/1	SHEET