



15ETH03  
15ETH03S  
15ETH03-1

**Ultrafast Rectifier**

**Features**

- Ultrafast Recovery Time
- Low Forward Voltage Drop
- Low Leakage Current
- 175°C Operating Junction Temperature

$t_{rr} = 40ns$
$I_{F(AV)} = 15Amp$
$V_R = 300V$

**Description/ Applications**

International Rectifier's 300V series are the state of the art Ultrafast recovery rectifiers designed with optimized performance of forward voltage drop and Ultrafast recovery time.

The planar structure and the platinum doped life time control guarantee the best overall performance, ruggedness and reliability characteristics.

These devices are intended for use in the output rectification stage of SMPS, UPS, DC-DC converters as well as freewheeling diodes in low voltage inverters and chopper motor drives.

Their extremely optimized stored charge and low recovery current minimize the switching losses and reduce over dissipation in the switching element and snubbers.

**Absolute Maximum Ratings**

Parameters	Max	Units
$V_{RRM}$ Repetitive Peak Reverse Voltage	300	V
$I_{F(AV)}$ Average Rectified Forward Current @ $T_C = 142^\circ C$	15	A
$I_{FSM}$ Non Repetitive Peak Surge Current @ $T_J = 25^\circ C$	140	
$T_J, T_{STG}$ Operating Junction and Storage Temperatures	- 65 to 175	$^\circ C$

Case Styles		
<p>15ETH03</p>  <p>TO-220AC</p>	<p>15ETH03S</p>  <p>D<sup>2</sup>PAK</p>	<p>15ETH03-1</p>  <p>TO-262</p>

**Electrical Characteristics @  $T_J = 25^\circ\text{C}$  (unless otherwise specified)**

Parameters	Min	Typ	Max	Units	Test Conditions
$V_{BR}, V_f$ Breakdown Voltage, Blocking Voltage	300	-	-	V	$I_R = 100\mu\text{A}$
$V_f$ Forward Voltage	-	1.05	1.25	V	$I_F = 15\text{A}, T_J = 25^\circ\text{C}$
	-	0.85	1.00	V	$I_F = 15\text{A}, T_J = 125^\circ\text{C}$
$I_R$ Reverse Leakage Current	-	0.05	40	$\mu\text{A}$	$V_R = V_R \text{ Rated}$
	-	12	400	$\mu\text{A}$	$T_J = 125^\circ\text{C}, V_R = V_R \text{ Rated}$
$C_T$ Junction Capacitance	-	45	-	pF	$V_R = 300\text{V}$
$L_S$ Series Inductance	-	8	-	nH	Measured lead to lead 5mm from package body

**Dynamic Recovery Characteristics @  $T_J = 25^\circ\text{C}$  (unless otherwise specified)**

Parameters	Min	Typ	Max	Units	Test Conditions
$t_{rr}$ Reverse Recovery Time	-	-	40	ns	$I_F = 1.0\text{A}, di_F/dt = 50\text{A}/\mu\text{s}, V_R = 30\text{V}$
	-	32	-		$T_J = 25^\circ\text{C}$
	-	45	-		$T_J = 125^\circ\text{C}$
$I_{RRM}$ Peak Recovery Current	-	2.4	-	A	$T_J = 25^\circ\text{C}$
	-	6.1	-		$T_J = 125^\circ\text{C}$
$Q_{rr}$ Reverse Recovery Charge	-	38	-	nC	$T_J = 25^\circ\text{C}$
	-	137	-		$T_J = 125^\circ\text{C}$

$I_F = 15\text{A}$   
 $di_F/dt = -200\text{A}/\mu\text{s}$   
 $V_R = 200\text{V}$

**Thermal - Mechanical Characteristics**

Parameters	Min	Typ	Max	Units
$T_J$ Max. Junction Temperature Range	- 65	-	175	$^\circ\text{C}$
$T_{Stg}$ Max. Storage Temperature Range	- 65	-	175	
$R_{thJC}$ Thermal Resistance, Junction to Case Per Leg	-	1.02	2.0	$^\circ\text{C}/\text{W}$
$R_{thJA}$ <sup>①</sup> Thermal Resistance, Junction to Ambient Per Leg	-	-	70	
$R_{thCS}$ <sup>②</sup> Thermal Resistance, Case to Heatsink	-	0.2	-	
$Wt$ Weight	-	2.0	-	g
	-	0.07	-	(oz)
Mounting Torque	6.0	-	12	Kg-cm
	5.0	-	10	lbf.in

① Typical Socket Mount

② Mounting Surface, Flat, Smooth and Greased

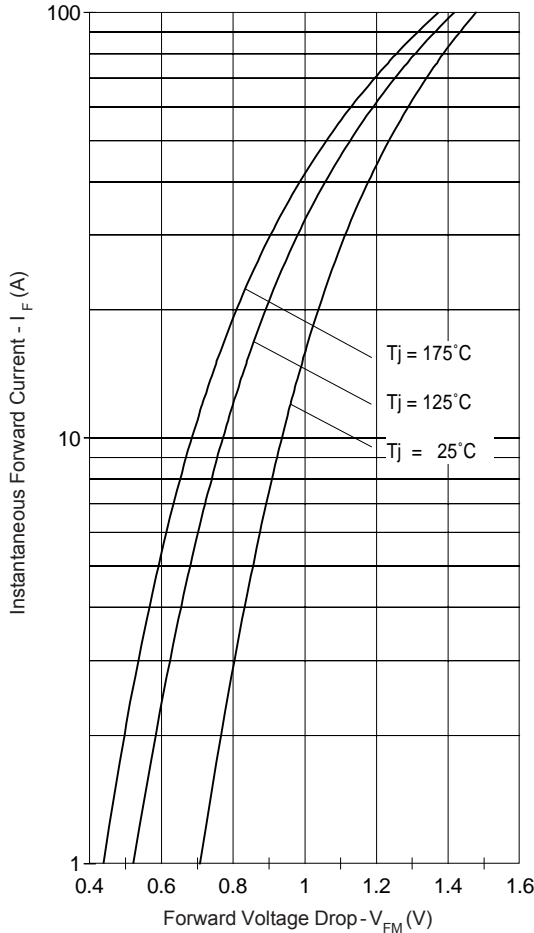

Fig. 1 - Typical Forward Voltage Drop Characteristics

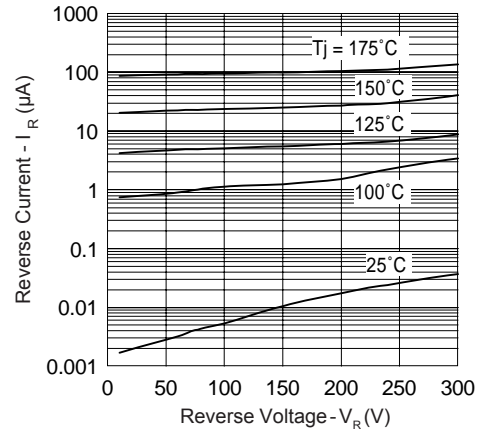

Fig. 2 - Typical Values Of Reverse Current Vs. Reverse Voltage

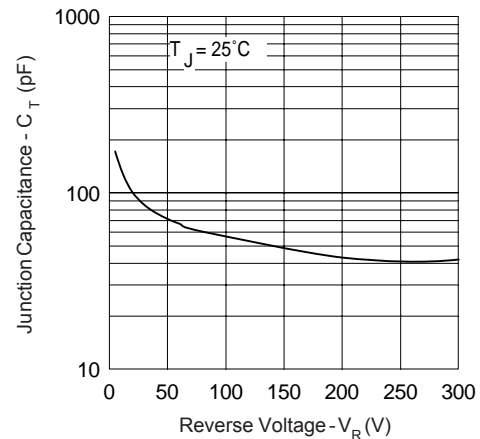

Fig. 3 - Typical Junction Capacitance Vs. Reverse Voltage

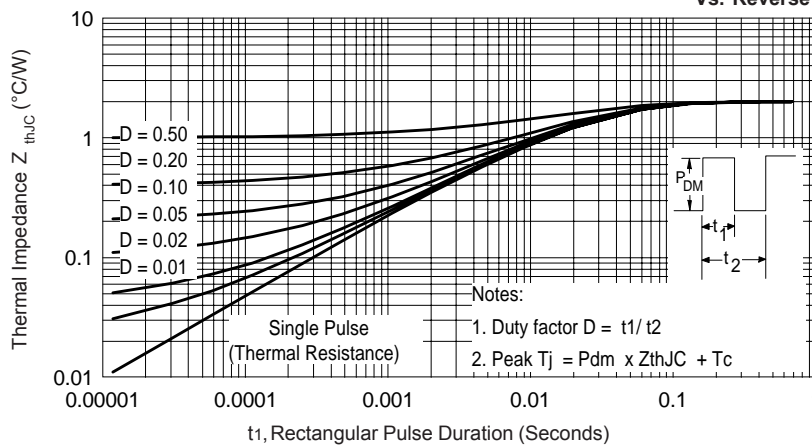

Fig. 4 - Max. Thermal Impedance  $Z_{thJC}$  Characteristics

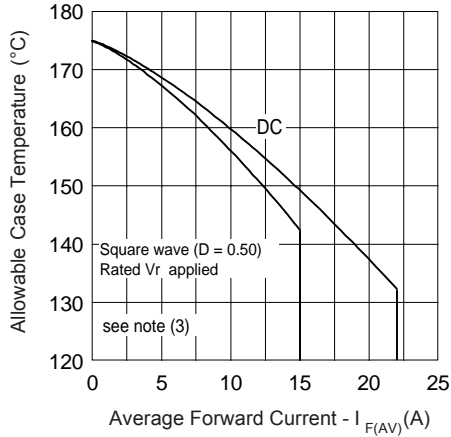

Fig. 5 - Max. Allowable Case Temperature Vs. Average Forward Current

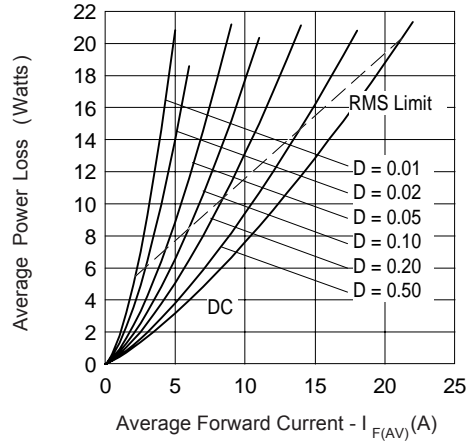

Fig. 6 - Forward Power Loss Characteristics

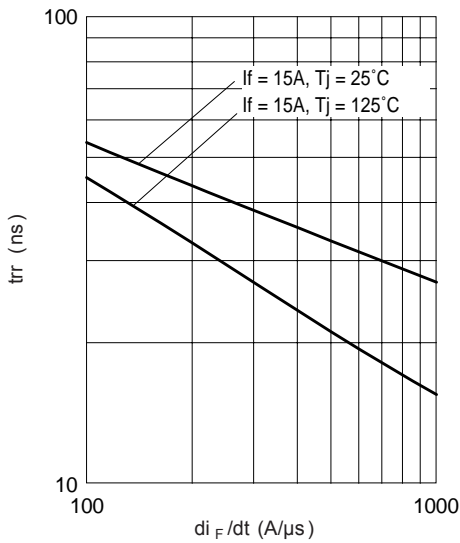

Fig. 7 - Typical Reverse Recovery vs.  $di_F/dt$

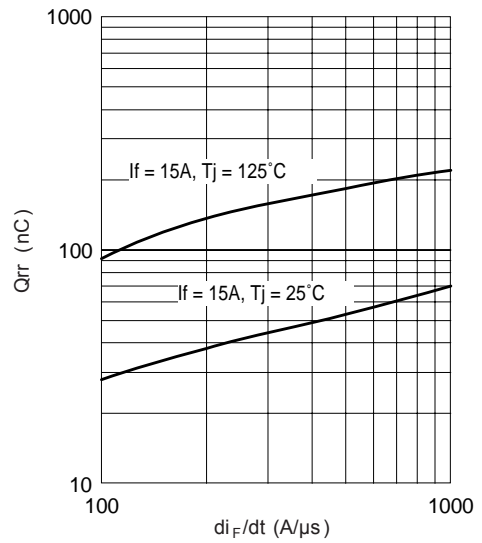

Fig. 8 - Typical Stored Charge vs.  $di_F/dt$

(3) Formula used:  $T_C = T_J - (Pd + Pd_{REV}) \times R_{thJC}$ ;

$Pd$  = Forward Power Loss =  $I_{F(AV)} \times V_{FM} @ (I_{F(AV)} / D)$  (see Fig. 6);

$Pd_{REV}$  = Inverse Power Loss =  $V_{R1} \times I_R (1 - D)$ ;  $I_R @ V_{R1}$  = rated  $V_R$

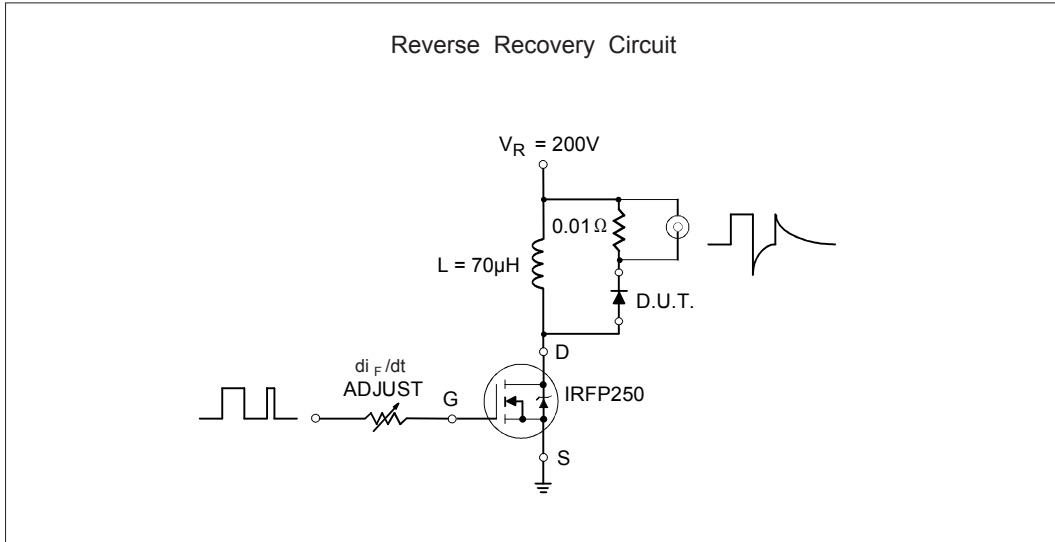

Fig. 9 - Reverse Recovery Parameter Test Circuit

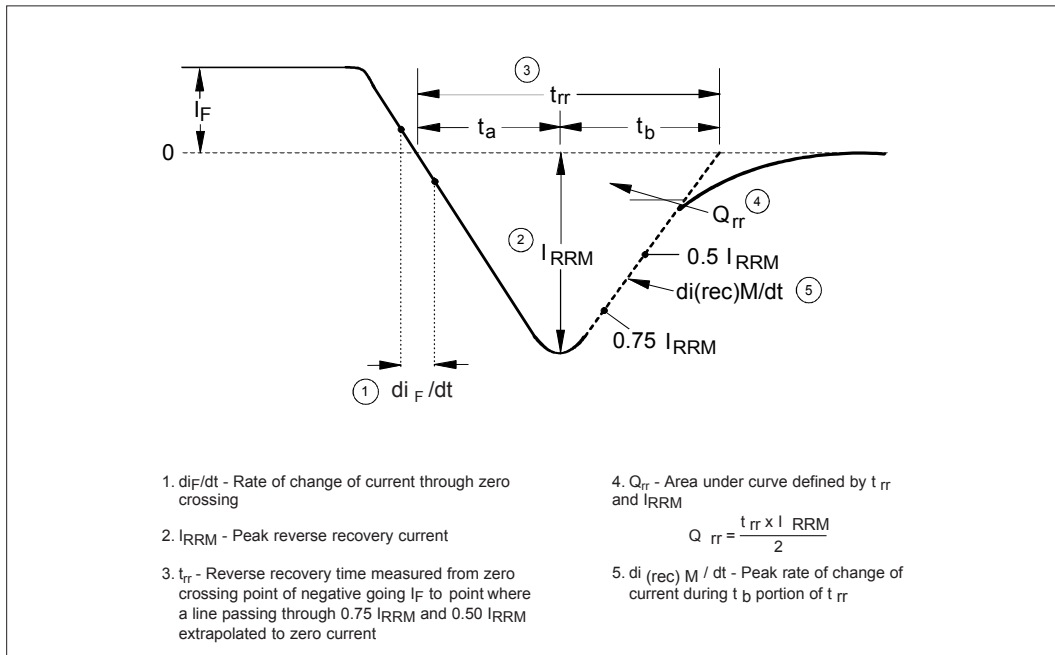
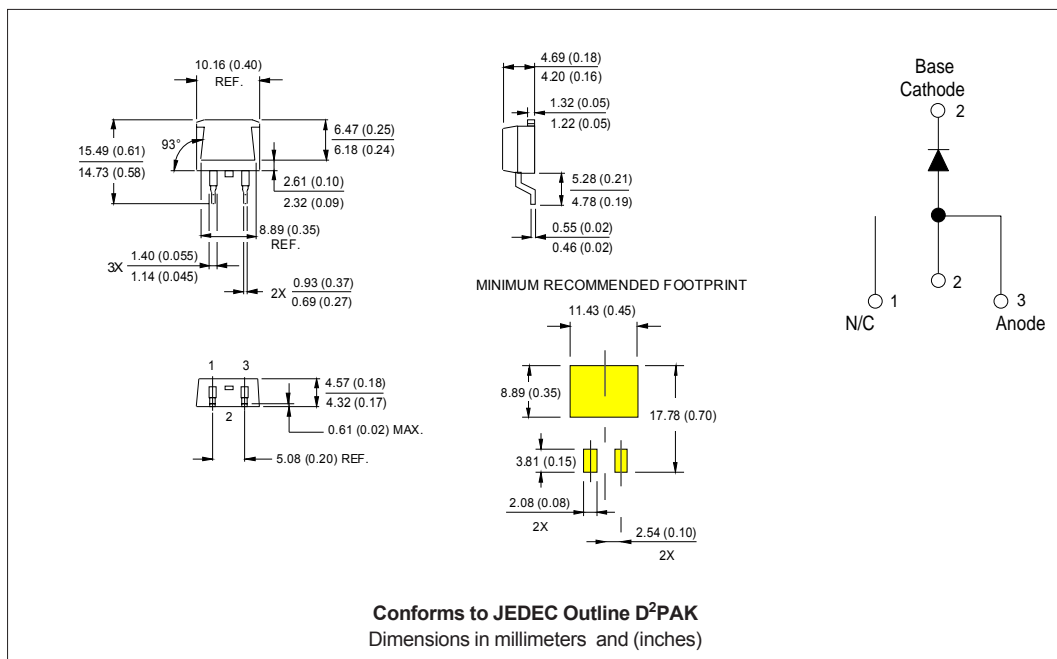
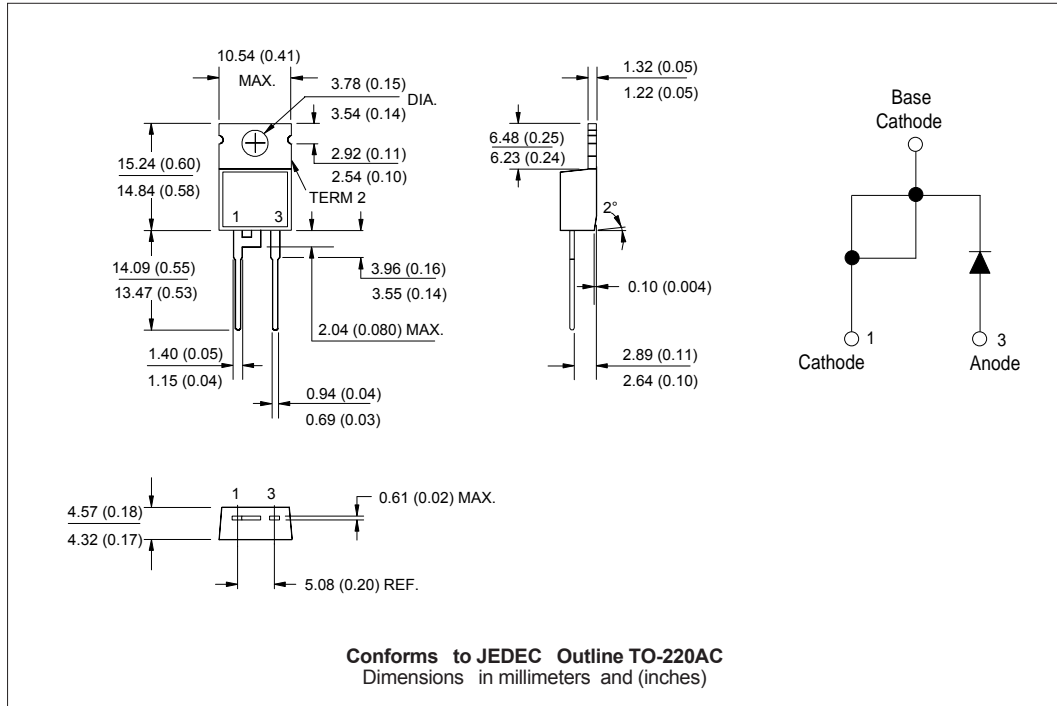
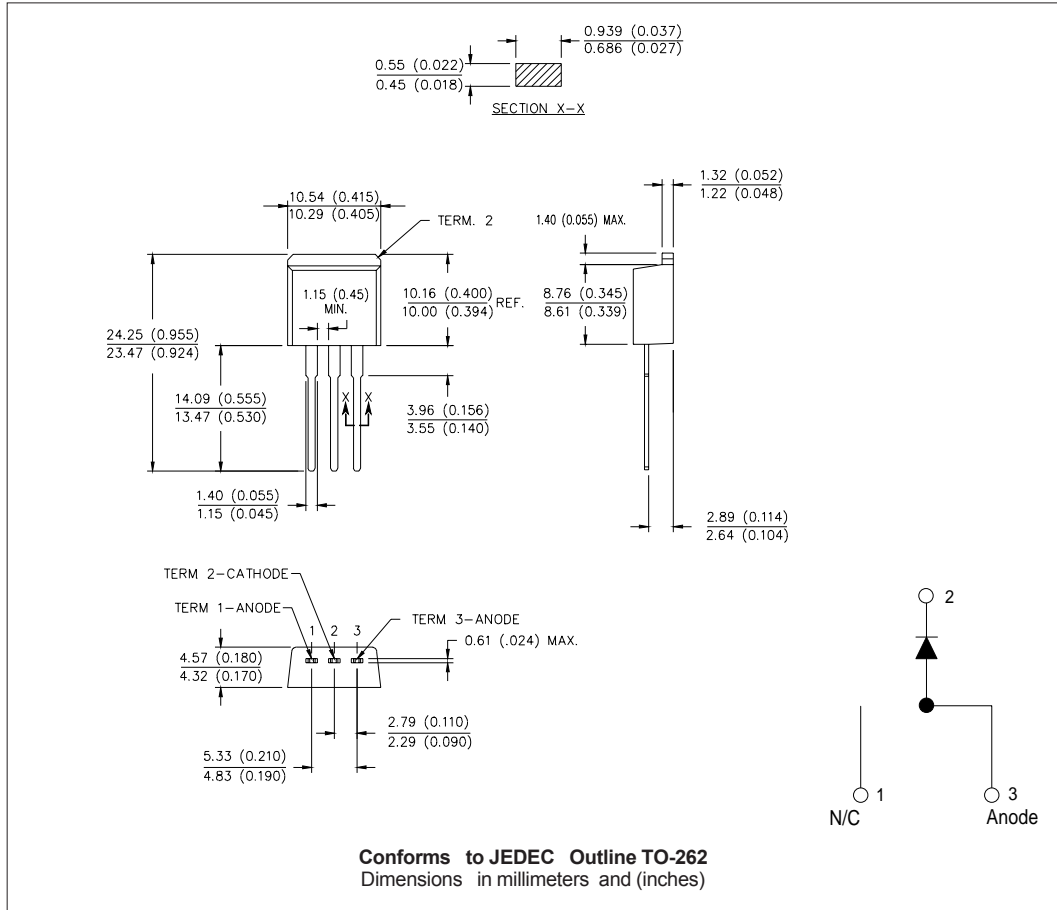

Fig. 10 - Reverse Recovery Waveform and Definitions

Outline Table



Outline Table



Marking Information

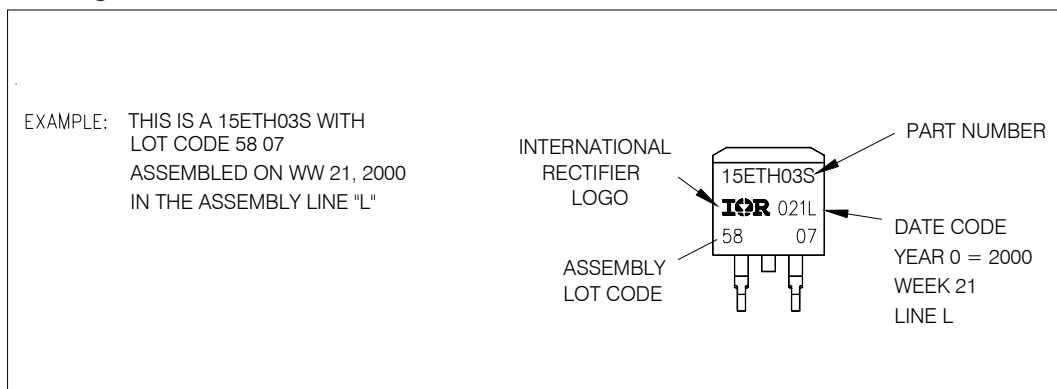

Part Marking Information

EXAMPLE: THIS IS A 15ETH03  
LOT CODE 1789  
ASSEMBLED ON WW 19, 1997  
IN THE ASSEMBLY LINE "C"

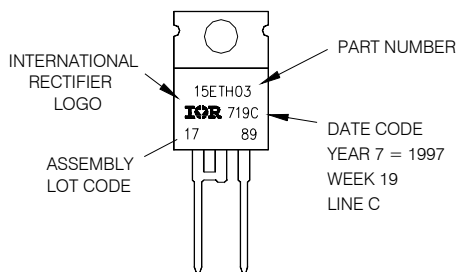

TO-220AC

EXAMPLE: THIS IS A 15ETH03S WITH  
LOT CODE 58 07  
ASSEMBLED ON WW 21, 2000  
IN THE ASSEMBLY LINE "L"

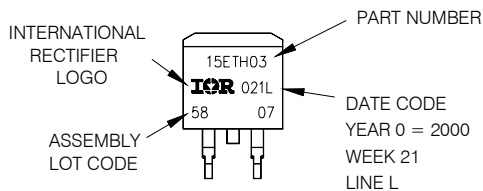

D2Pak

EXAMPLE: THIS IS A 15ETH03-1  
LOT CODE 1789  
ASSEMBLED ON WW 19, 1997  
IN THE ASSEMBLY LINE "C"

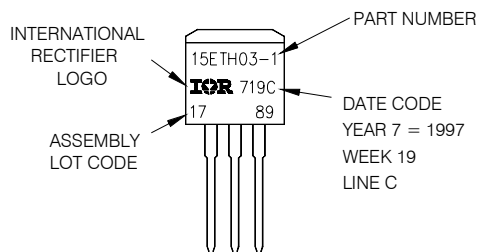

TO-262

Data and specifications subject to change without notice.  
This product has been designed and qualified for Industrial Level.  
Qualification Standards can be found on IR's Web site.