

1N458

FEATURES

- 1N458 AVAILABLE AS 1N458A, & AS JAN1N458 PER MIL-PRF-19500/193
- SWITCHING DIODE
- METALLURGICALLY BONDED
- HERMETICALLY SEALED
- DOUBLE PLUG CONSTRUCTION

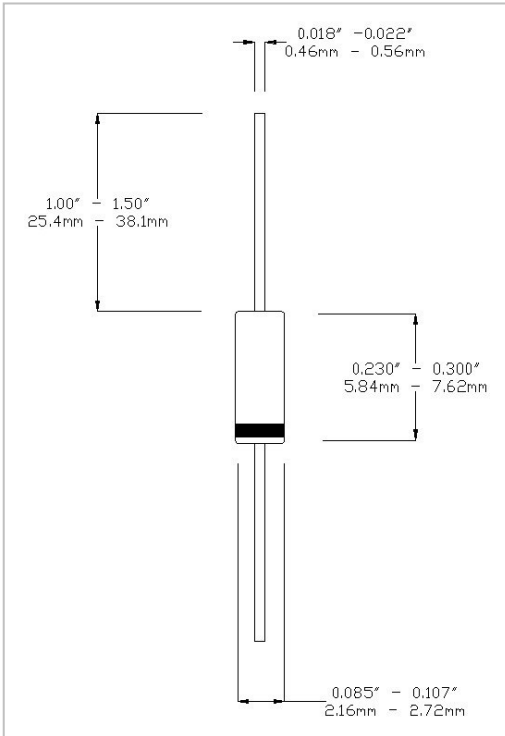

MAXIMUM RATINGS AT 25 °C

Operating Temperature:	-65°C to +175°C
Storage Temperature:	-65°C to +175°C
Surge Current A, sine, 8.3mS:	165mA
Total Power Dissipation:	500mW
Operating Current:	55mA, T _A = +25°C
Derating Factor:	0.44mA/°C above T _A = +25°C
D.C. Reverse Voltage (VRWM):	125V

DESIGN DATA

Case: Hermetically sealed glass package per MIL-PRF-19500/193 DO-7 outline

Lead Material: Copper clad steel

Lead Finish: Tin/Lead

Thermal Impedance (Z_{θJX}): 70°C/W maximum

Marking: Blue body coat. Black digits.

Polarity: Cathode end is banded.

DC ELECTRICAL CHARACTERISTICS

V _F				I _R			
Ambient (°C)	I _F mA	Min V	Max V	Ambient (°C)	V (dc)	Min μA	Max μA
25	7	-	1	25	125	-	0.025
				25	150(ac)	-	100.0
				150	125	-	5.0



WWW.MICROSEMI.COM

IRELAND - GORT ROAD, ENNIS, CO. CLARE

PHONE: +353 65 6840044
TOLL FREE: +186 62 702434
FAX: +353 65 6822298

U.S.A. DOMESTIC SALES CONTACT

PHONE: (617) 926 0404
TOLL FREE: 1 800 666 2999