



Micro Commercial Components
 21201 Itasca Street Chatsworth
 CA 91311
 Phone: (818) 701-4933
 Fax: (818) 701-4939

1N4942

THRU

1N4948

Features

- Low Leakage Current
- Metalurgically Bonded Construction
- Low Cost
- Fast Switching For High Efficiency

**1 Amp Fast Recovery
 Rectifier
 200 to 1000 Volts**

Maximum Ratings

- Operating Temperature: -55°C to +150°C
- Storage Temperature: -55°C to +150°C
- Maximum Thermal Resistance; 50°C/W Junction To Ambient

Microsemi Catalog Number	Device Marking	Maximum Recurrent Peak Reverse Voltage	Maximum RMS Voltage	Maximum DC Blocking Voltage
1N4942	---	200V	140V	200V
1N4944	---	400V	280V	400V
1N4946	---	600V	420V	600V
1N4947	---	800V	560V	800V
1N4948	---	1000V	700V	1000V

DO-41

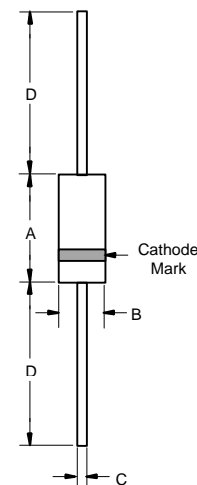

Electrical Characteristics @ 25°C Unless Otherwise Specified

Average Forward Current	$I_{F(AV)}$	1.0A	$T_A = 55^\circ\text{C}$
Peak Forward Surge Current	I_{FSM}	25A	8.3ms, half sine
Maximum Instantaneous Forward Voltage	V_F	1.3V	$I_{FM} = 1.0\text{A}; T_A = 25^\circ\text{C}^*$
Maximum DC Reverse Current At Rated DC Blocking Voltage	I_R	5.0 μA 500 μA	$T_J = 25^\circ\text{C}$ $T_J = 175^\circ\text{C}$
Maximum Reverse Recovery Time	T_{rr}	150ns 250ns 500ns	$I_F = 0.5\text{A},$ $I_R = 1.0\text{A},$ $I_{rr} = 0.25\text{A}$
1N4942-4944			
1N4946-4947 1N4948			
Typical Junction Capacitance	C_J	15pF	Measured at 1.0MHz, $V_R = 4.0\text{V}$

DIM	INCHES		MM		NOTE
	MIN	MAX	MIN	MAX	
A	.166	.205	4.10	5.20	
B	.080	.107	2.00	2.70	
C	.028	.034	.70	.90	
D	1.000	---	25.40	---	

*Pulse test: Pulse width 300 μsec , Duty cycle 2%

1N4942 thru 1N4948

Figure 1
Typical Forward Characteristics

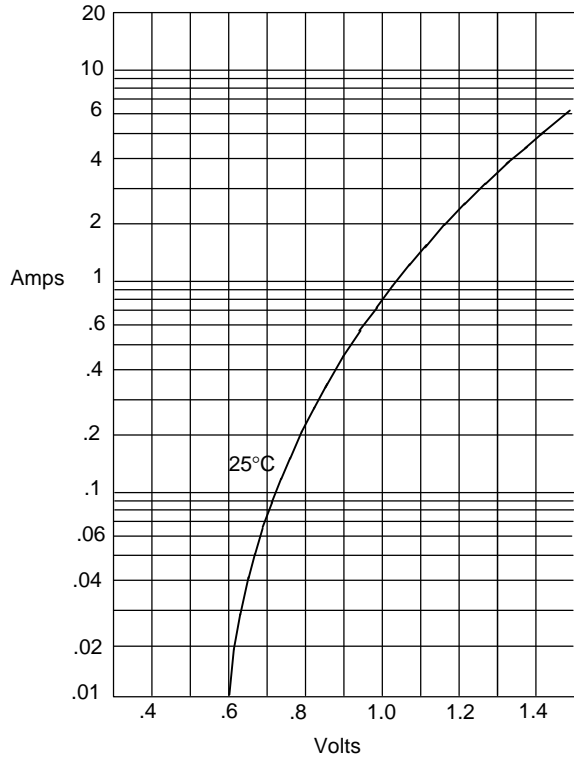

Instantaneous Forward Current - Amperes *versus*
Instantaneous Forward Voltage - Volts

Figure 2
Forward Derating Curve

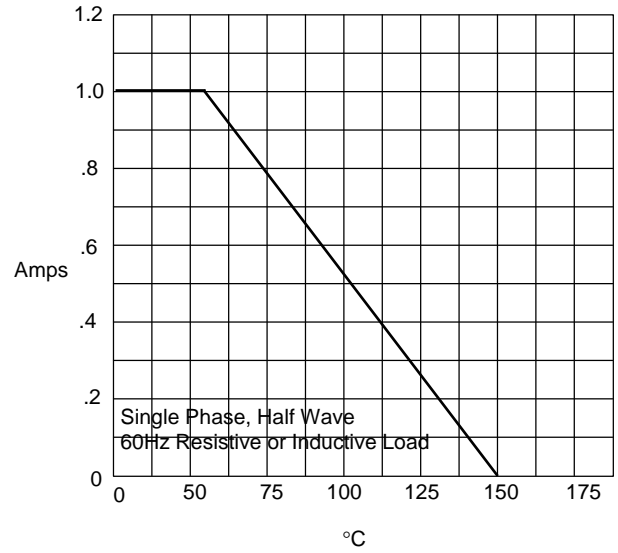

Average Forward Rectified Current - Amperes *versus*
Ambient Temperature - °C

Figure 3
Junction Capacitance

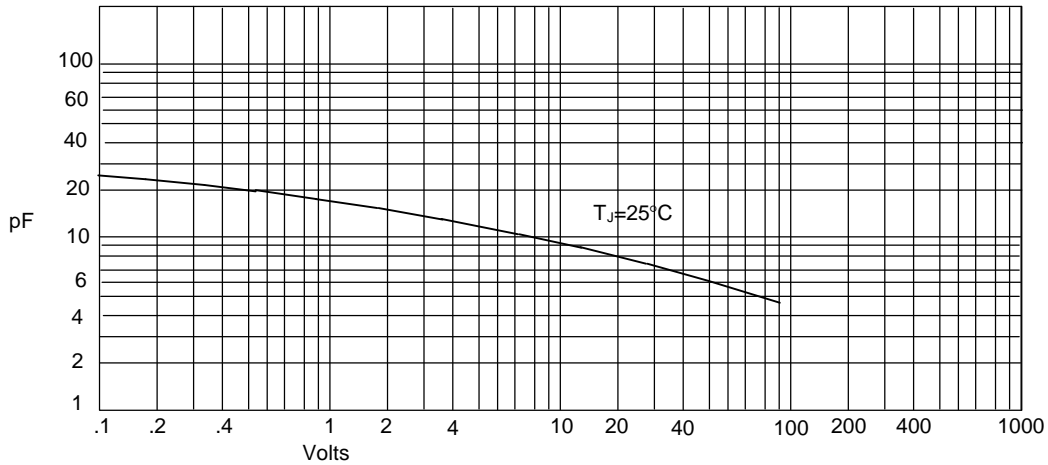

Junction Capacitance - pF *versus*
Reverse Voltage - Volts

1N4942 thru 1N4948

Figure 4
Typical Reverse Characteristics

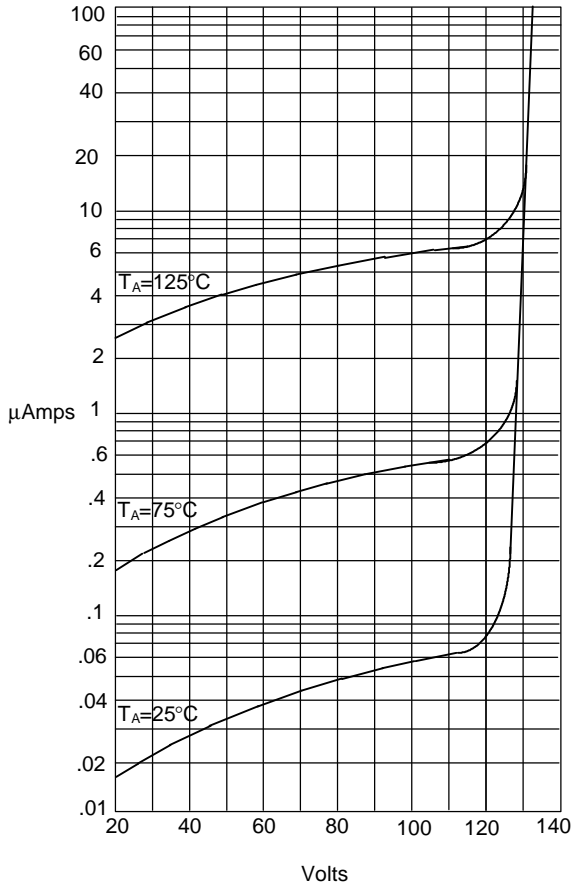

Instantaneous Reverse Leakage Current - MicroAmpere *versus* Percent Of Rated Peak Reverse Voltage - Volts

Figure 5
Non-Repetitive Peak Forward Surge Current

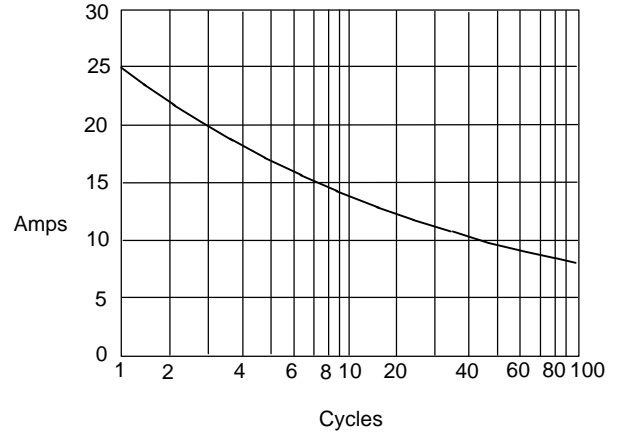

Peak Forward Surge Current - Amperes *versus* Number Of Cycles At 60Hz - Cycles

Figure 6
Reverse Recovery Time Characteristic And Test Circuit Diagram

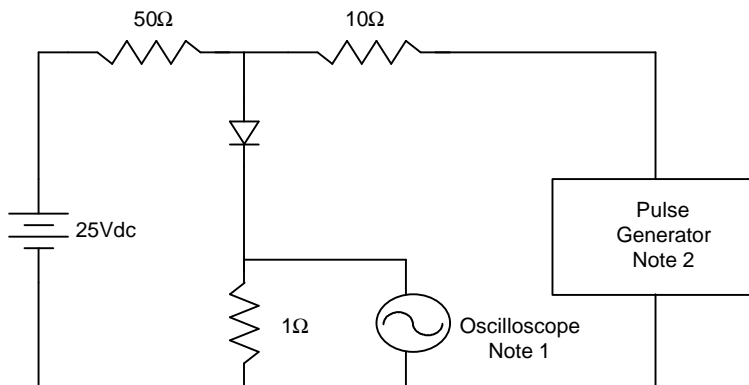

- Notes:
1. Rise Time = 7ns max.
Input impedance = 1 megohm, 22pF
 2. Rise Time = 10ns max.
Source impedance = 50 ohms
 3. Resistors are non-inductive

