



## ACST8-8C

### ASD™ AC Switch Family

### OVER VOLTAGE PROTECTED AC POWER SWITCH

#### MAIN APPLICATIONS

- AC static switching in appliance & industrial control systems
- Washing machine with bi-rotational induction motor drive
- Induction motor drive for:
  - refrigerator / freezer compressor
  - air conditioning compressor

#### FEATURES

- $V_{DRM} / V_{RRM} = \pm 800V$
- Avalanche controlled device
- $I_{T(RMS)} = 8A$  with  $T_{CASE} = 90\text{ }^{\circ}C$
- High noise immunity: static  $dV/dt > 750\text{ V}/\mu s$
- Gate triggering current :  $I_{GT} < 30\text{ mA}$
- Snubberless turn off commutation:  $(dI/dt)_c > 4.5A/ms$
- TO-220FPAB package

#### BENEFITS

- Enables equipment to meet EN61000-4-5 standard
- High off-state reliability with planar technology
- Need no external overvoltage protection
- Reduces the power component count

#### DESCRIPTION

The ACST8-8C belongs to the AC power switch family built around the ASD technology. This high performance device is adapted to home appliances or industrial systems and drives an induction motor up to 8A.

This ACST switch embeds a triac structure with a high voltage clamping device to absorb the inductive turn off energy and withstand line transients such as those described in the IEC61000-4-5 standards.

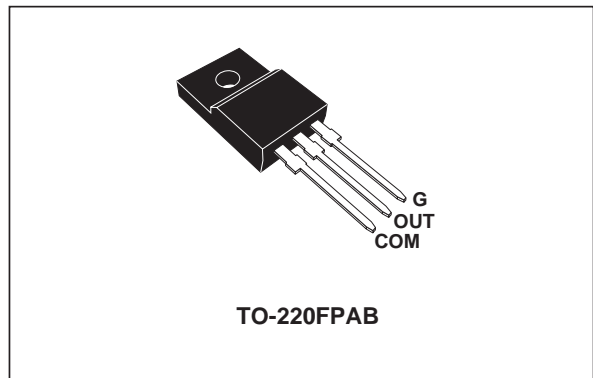

#### FUNCTIONAL DIAGRAM:

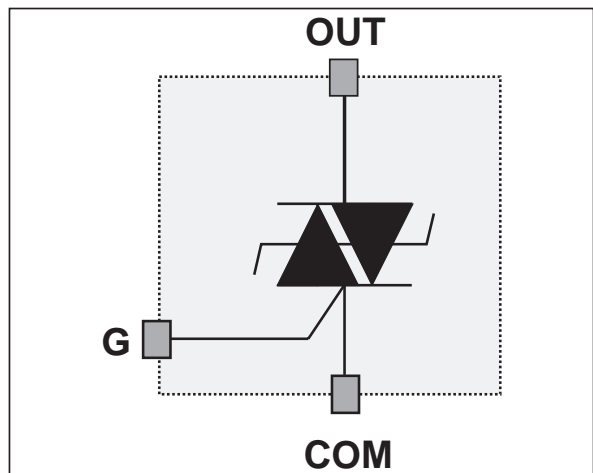

## ACST8-8C

### ABSOLUTE RATINGS (limiting values)

Symbol	Parameter	Value	Unit	
$V_{DRM} / V_{RRM}$	Repetitive peak off-state voltage	800	V	
$I_{T(RMS)}$	RMS on-state current full cycle sine wave 50 to 60 Hz	$T_{case} = 90^{\circ}C$ 8	A	
$I_{TSM}$	Non repetitive surge peak on-state current $T_j$ initial = $25^{\circ}C$ , full cycle sine wave	$t_p = 20ms$	80	A
		$t_p = 16.7ms$	85	A
$I^2t$	Thermal constraint for fuse selection	$t_p = 10ms$	35	$A^2s$
$dl/dt$	Non repetitive on-state current critical rate of rise $I_G = 10mA$ ( $t_r < 100ns$ )	Rate period > 1mn	100	$A/\mu s$
$V_{PP}$	Non repetitive line peak pulse voltage	note 1	2	kV
$T_{stg}$	Storage temperature range		- 40 to + 150	$^{\circ}C$
$T_j$	Operating junction temperature range		- 40 to + 125	$^{\circ}C$
$T_I$	Maximum lead soldering temperature during 10s		260	$^{\circ}C$

**Note 1:** according to test described by IEC61000-4-5 standard & Figure A.

### GATE CHARACTERISTICS (maximum values)

Symbol	Parameter	Value	Unit
$P_{G(AV)}$	Average gate power dissipation	0.1	W
$P_{GM}$	Peak gate power dissipation ( $t_p = 20\mu s$ )	10	W
$I_{GM}$	Peak gate current ( $t_p = 20\mu s$ )	1	A

### THERMAL RESISTANCE

Symbol	Parameter	Value	Unit
$R_{th(j-a)}$	Junction to ambient	60	$^{\circ}C/W$
$R_{th(j-c)}$	Junction to case for full cycle sine wave conduction	3.5	$^{\circ}C/W$

### PARAMETER DESCRIPTION

Parameter Symbol	Parameter description
$I_{GT}$	Gate triggering current
$V_{GT}$	Gate triggering voltage
$V_{GD}$	Non triggering voltage
$I_H$	Holding current
$I_L$	Latching current
$V_{TM}$	On state voltage
$V_{TO}$	On state characteristic threshold voltage
$R_D$	On state characteristic dynamic resistance
$I_{DRM} / I_{RRM}$	Forward or reverse leakage current
$dV/dt$	Static pin OUT voltage rise
$(dl/dt)_c$	Turn off current rate of decay
$V_{CL}$	Avalanche voltage at turn off

**ELECTRICAL CHARACTERISTICS PER SWITCH**

For either positive or negative polarity of pin OUT voltage respect to pin COM voltage

Symbol	Test conditions		Values	Unit	
$I_{GT}$	$V_{OUT} = 12V$ (DC) $R_L = 33\Omega$	$T_j = 25^\circ C$	MAX.	30	mA
$V_{GT}$	$V_{OUT} = 12V$ (DC) $R_L = 33\Omega$	$T_j = 25^\circ C$	MAX.	1.5	V
$V_{GD}$	$V_{OUT} = V_{DRM}$ $R_L = 3.3k\Omega$	$T_j = 125^\circ C$	MIN.	0.2	V
$I_H$	$I_{OUT} = 100mA$ Gate open	$T_j = 25^\circ C$	MAX.	40	mA
$I_L$	$I_G = 20mA$	$T_j = 25^\circ C$	MAX.	70	mA
$V_{TM}$	$I_{OUT} = 11A$ $t_p = 380\mu s$	$T_j = 25^\circ C$	MAX.	1.5	V
$V_{TO}$		$T_j = 125^\circ C$	MAX.	0.95	V
$R_D$		$T_j = 125^\circ C$	MAX.	50	m $\Omega$
$I_{DRM}$ $I_{RRM}$	$V_{OUT} = V_{DRM}$ $V_{OUT} = V_{RRM}$	$T_j = 25^\circ C$	MAX.	10	$\mu A$
		$T_j = 125^\circ C$	MAX.	1	mA
$dV/dt$	$V_{OUT} = 550V$ gate open	$T_j = 125^\circ C$	MIN.	750	V/ $\mu s$
$(dl/dt)_c$	Without snubber	$T_j = 125^\circ C$	MIN.	4.5	A/ms
$V_{CL}$	$I_{CL} = 1mA$ $t_p = 1ms$	$T_j = 25^\circ C$	TYP.	1200	V

**AC LINE SWITCH BASIC APPLICATION**

The ACST8-8C device is especially designed to drive medium power induction motors in washing machines, refrigerators, dish washers, and tumble dryers.

Pin COM : Common drive reference, to be connected to the power line neutral  
 Pin G : Switch Gate input to be connected to the controller  
 Pin OUT : Switch Output to be connected to the load

When driven from a low voltage controller, the ACST switch is triggered with a negative gate current flowing out of the gate pin G. It can be driven by the controller through a resistor as shown on the typical application diagram. In appliance systems, the ACST8-8C switch intends to drive medium power load in ON / OFF full cycle or phase angle control mode.

Thanks to its thermal and turn-off commutation characteristics, the ACST8-8C switch is able to drive an inductive load up to 8A without a turn-off aid snubber circuit.

In washing machine or drier appliances, the tumble rotates in both directions. When using bidirectional phase shift induction motor, two switches are connected on each side of the phase shift capacitor: in steady-state operation, one switch only conducts energising the coils and defining the tumble direction.

TYPICAL APPLICATION DIAGRAM

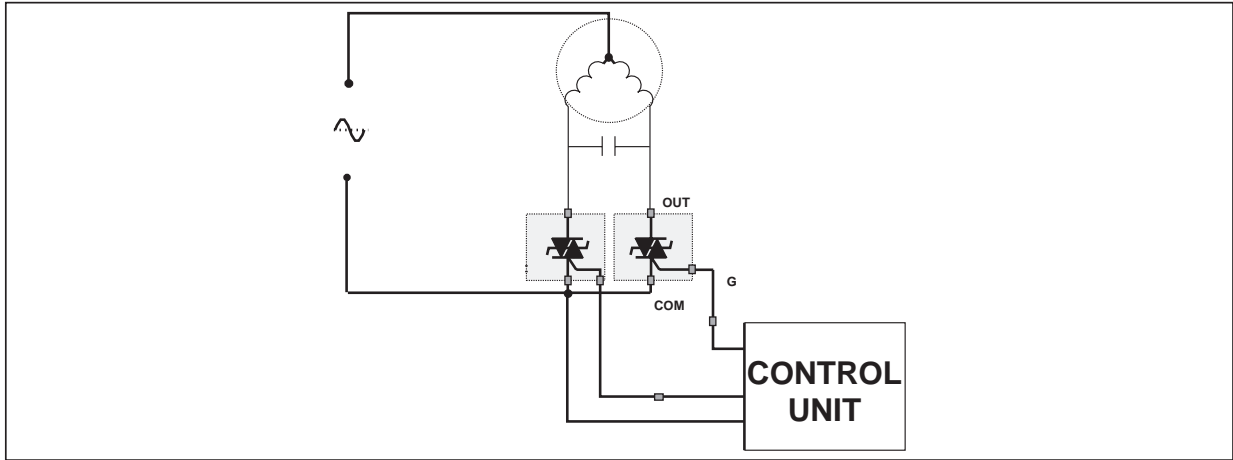

ROBUSTNESS AGAINST FAST CAPACITOR DISCHARGE

When parasitic transients or controller mis-operation occur, the blocked switch may turn on by spurious switch firing. Since the phase shift capacitor is charged, its energy is instantaneously dissipated through the two ACSTs which can be destroyed. To prevent such a failure, a resistive inductive circuit R-L is added in series with the phase shift capacitor.

The  $di/dt$  depends on the maximal voltage  $V_{max}$  of the phase shift capacitor (700V on 240V mains applications), and on the inductance L:

$$\frac{di}{dt} = \frac{V_{max}}{L}$$

The total switch turn on  $di/dt$  is the sum of the  $di/dt$  created by any RC noise suppressor discharge and the  $di/dt$  created by the motor capacitor discharge.

Since the maximal  $di/dt$  capability at turn-on of the ACST8 is  $100A/\mu s$ , the motor capacitor  $di/dt$  is assumed to be less than  $50A/\mu s$ ; therefore, the inductance should be  $14\mu H$ .

The resistor R limits the surge current through the ACST8 during the capacitor discharge according to the specified curve  $I_{TSM} = f(t_p)$  as shown in Figure 6 (*to be issued*), and  $1.2 \Omega$  is low enough to limit the resistor dissipation (usually less than 1 W).

Finally both the  $14\mu H$  inductance and the  $1.2\Omega$  resistance provide a safety margin of two on the surge current  $I_{TSM}$  described in Figure 6.

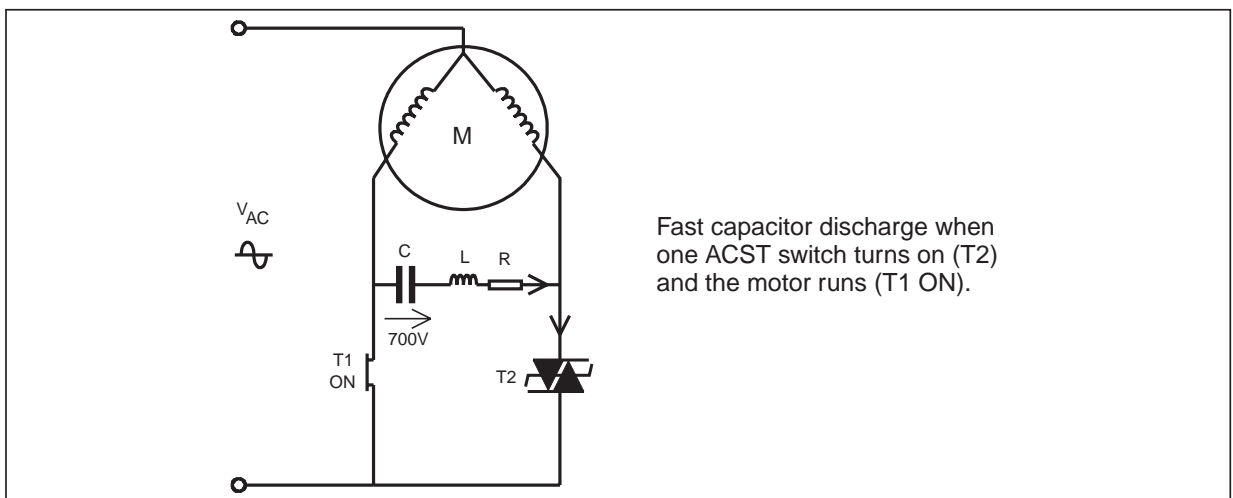

**AC LINE TRANSIENT VOLTAGE RUGGEDNESS**

The ACST8-8C switch is able to safely withstand the AC line transient voltages either by clamping the low energy spikes or by breaking over under high energy shocks.

The test circuit in Figure A is representative of the ACST application and is used to test the ACST switch according to the IEC61000-4-5 standard conditions. Thanks to the load impedance, the ACST switch withstands voltage spikes up to 2 kV above the peak line voltage by breaking over safely. Such non repetitive testing can be done 10 times on each AC line voltage polarity.

**Fig. A:** Overvoltage ruggedness test circuit for resistive and inductive loads according to IEC61000-4-5 standard  $R = 47\Omega$ ,  $L = 10\mu H$  &  $V_{PP} = 2kV$

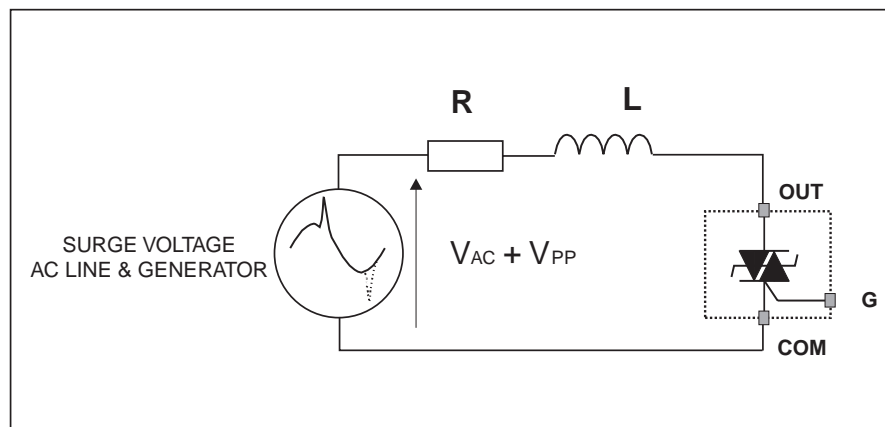

**Fig. 1:** Maximum power dissipation versus RMS on-state current.

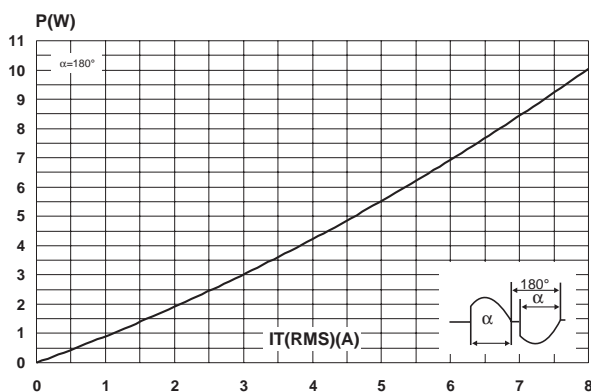

**Fig. 2-1:** RMS on-state current versus case temperature.

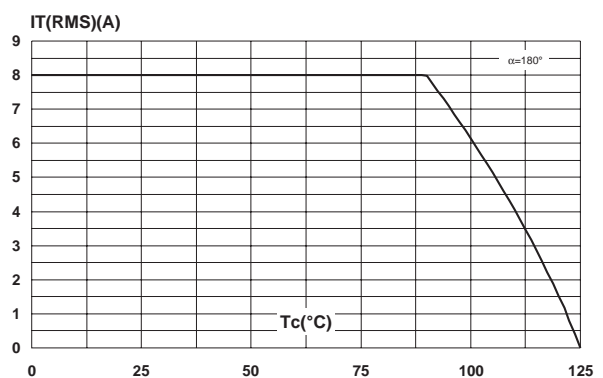

**Fig. 2-2:** RMS on-state current versus ambient temperature.

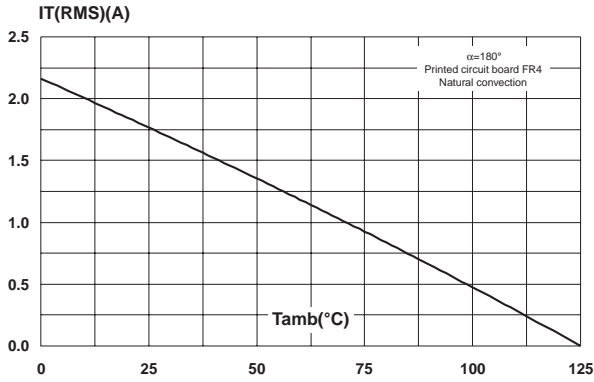

**Fig. 3:** Relative variation of thermal impedance versus pulse duration.

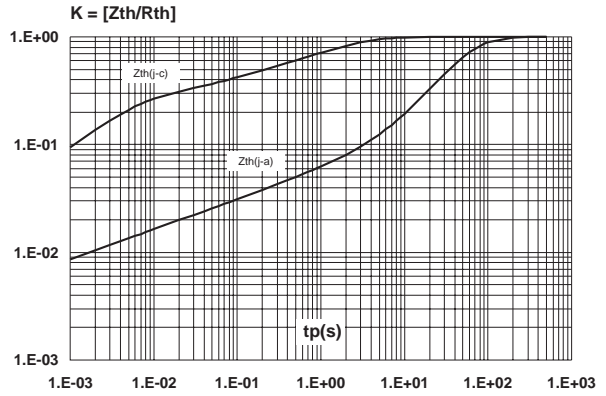

**Fig. 4:** On-state characteristics (maximum values).

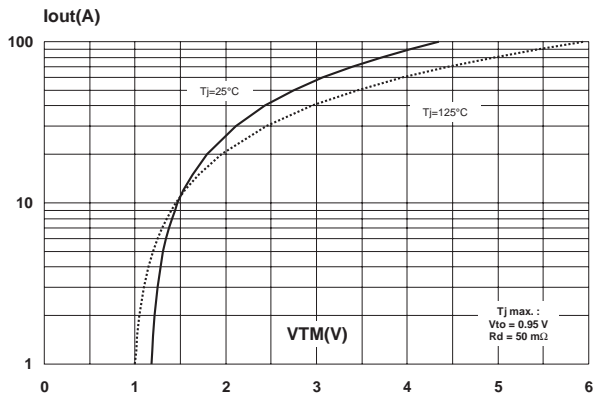

**Fig. 5:** Surge peak on-state current versus number of cycles.

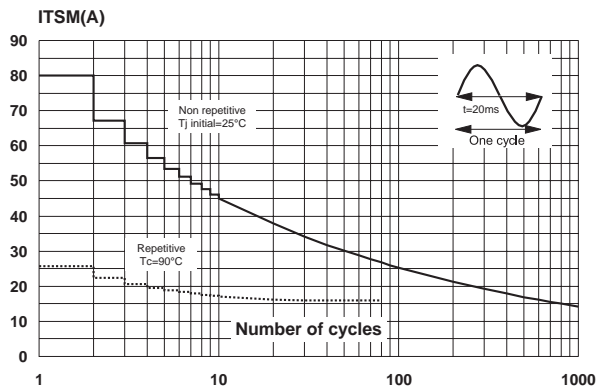

**Fig. 6:** Non repetitive surge peak on-state current for a sinusoidal pulse with width  $t_p < 10\text{ms}$ , and corresponding value of  $I^2t$ .

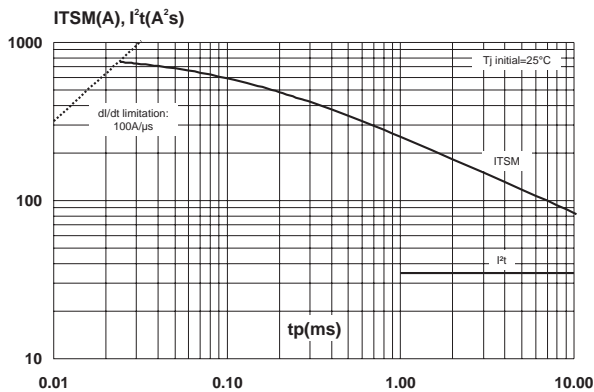

**Fig. 7:** Relative variation of gate trigger current, holding current and latching current versus junction temperature (typical values).

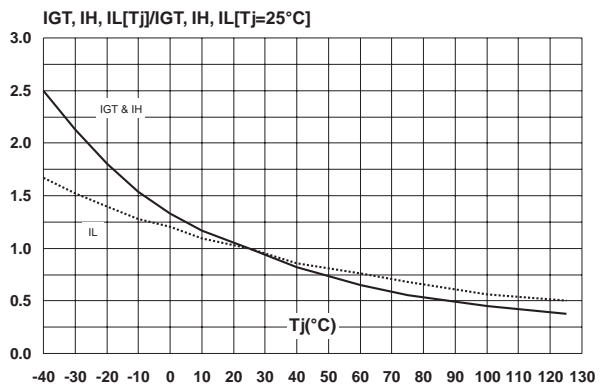

**Fig. 8:** Relative variation of critical rate of decrease of main current versus reapplied dV/dt (typical values).

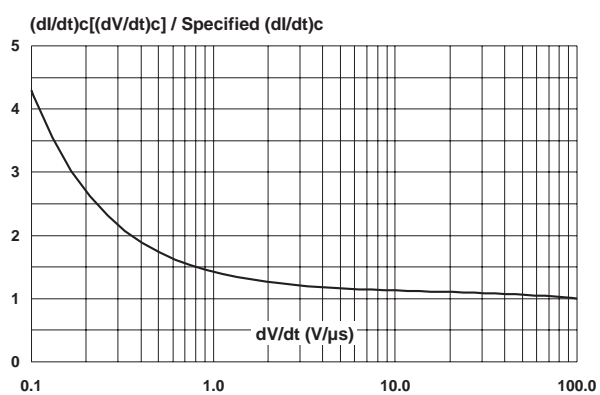

**Fig. 9:** Relative variation of critical rate of decrease of main current versus junction temperature.

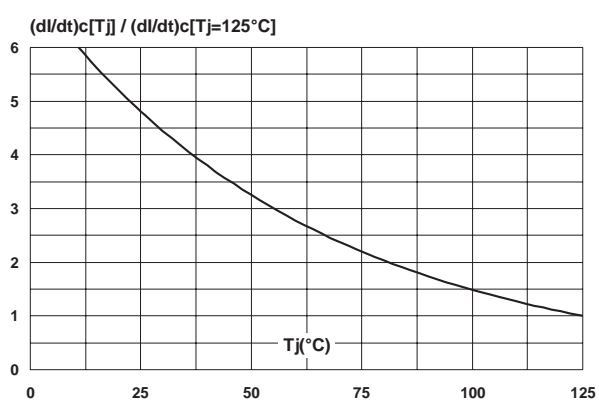

**Fig. 10:** Relative variation of static dV/dt versus junction temperature

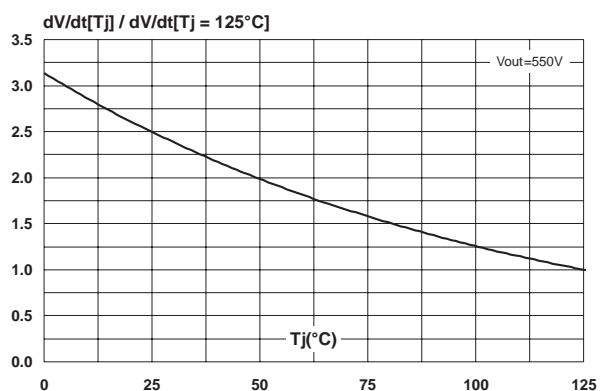

**ORDERING INFORMATION**

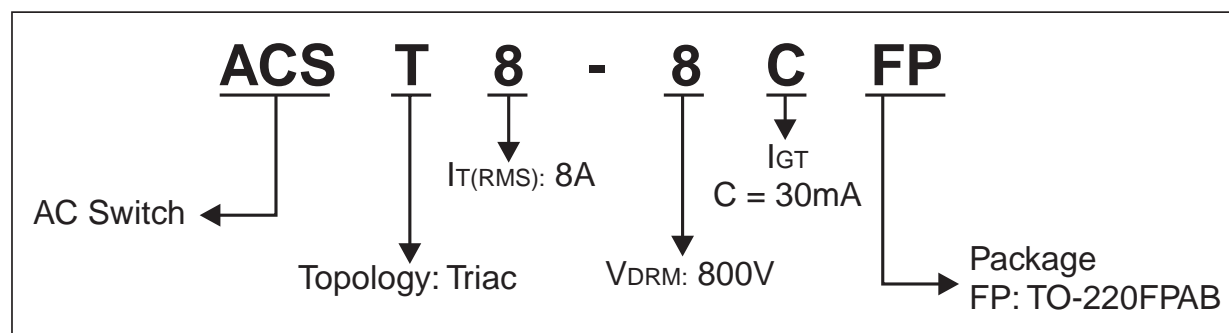

# ACST8-8C

## PACKAGE MECHANICAL DATA TO-220FPAB (Plastic)

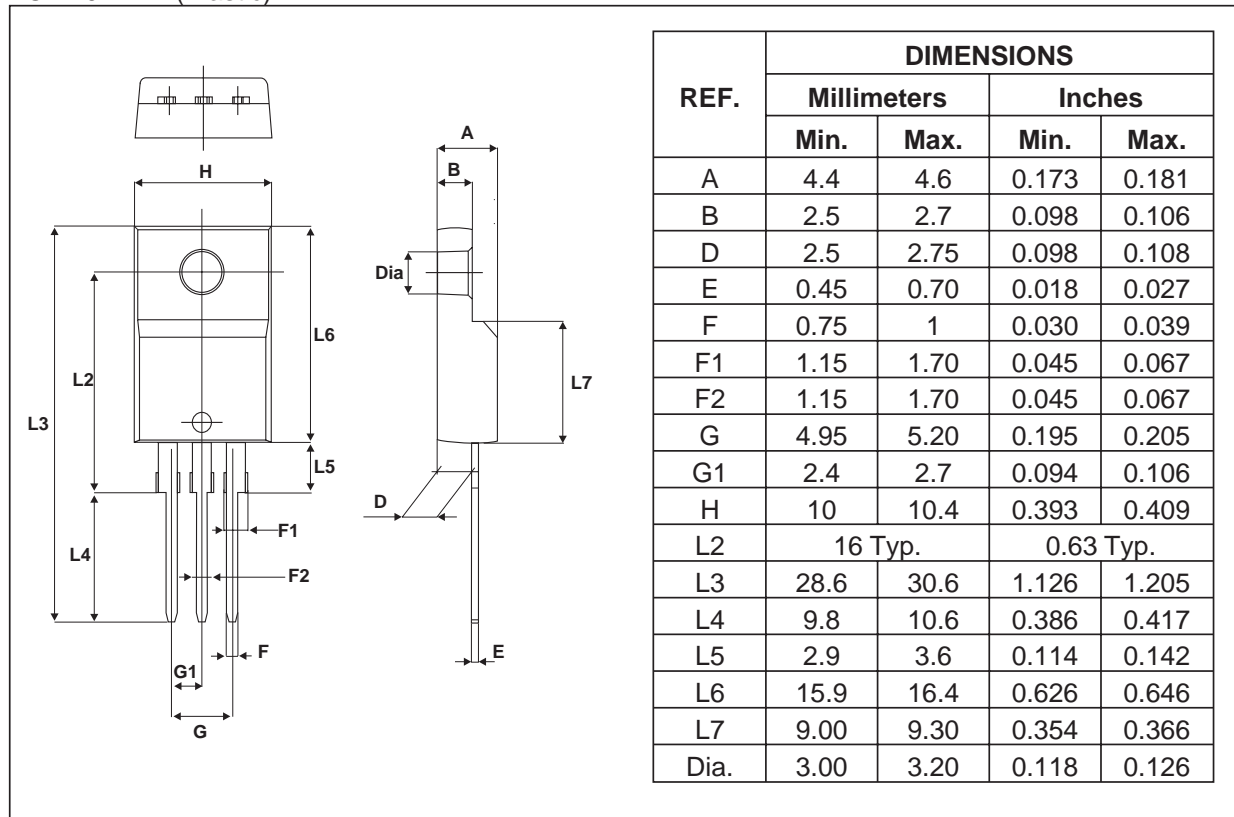

### OTHER INFORMATION

Ordering type	Marking	Package	Weight	Base qty	Delivery mode
ACST8-8CFP	ACST88C	TO-220FPAB	2.4 g	50	Tube

- Epoxy meets UL94,V0

Information furnished is believed to be accurate and reliable. However, STMicroelectronics assumes no responsibility for the consequences of use of such information nor for any infringement of patents or other rights of third parties which may result from its use. No license is granted by implication or otherwise under any patent or patent rights of STMicroelectronics. Specifications mentioned in this publication are subject to change without notice. This publication supersedes and replaces all information previously supplied. STMicroelectronics products are not authorized for use as critical components in life support devices or systems without express written approval of STMicroelectronics.

The ST logo is a registered trademark of STMicroelectronics  
 © 2002 STMicroelectronics - Printed in Italy - All rights reserved.  
 STMicroelectronics GROUP OF COMPANIES  
 Australia - Brazil - Canada - China - Finland - France - Germany  
 Hong Kong - India - Israel - Italy - Japan - Malaysia - Malta - Morocco - Singapore  
 Spain - Sweden - Switzerland - United Kingdom - United States.

<http://www.st.com>

