

Variable Capacitance Diode

Description

The 1T387 is a variable capacitance diode designed for electronic tuning of BS and CS tuners using a super miniature package (SMVC).

Features

- Super miniature package
- Low series resistance: 1.5Ω Max. (f = 470MHz)
- Large capacitance ratio: 14.6 Typ. (C<sub>1</sub>/C<sub>25</sub>)
- Small leakage current: 10nA Max. (V<sub>R</sub> = 25V)
- Capacitance deviation in a matching group: within 6%

Applications

Electronic tuning of BS and CS tuners

Structure

Silicon epitaxial planar type diode

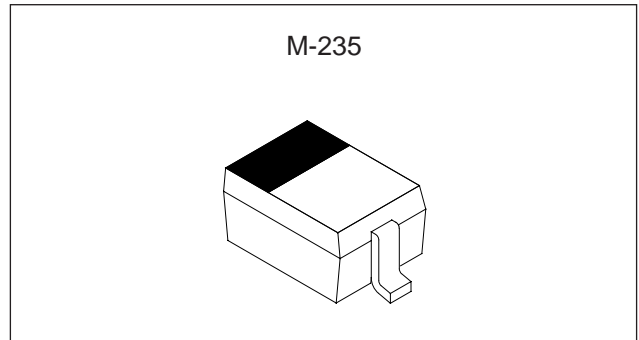

Absolute Maximum Ratings (Ta = 25°C)

- Reverse voltage V<sub>R</sub> 30 V
- Peak reverse voltage V<sub>RM</sub> 35 V (R<sub>L</sub> ≥ 10kΩ)
- Operating temperature Topr -20 to +75 °C
- Storage temperature Tstg -65 to +150 °C

Electrical Characteristics

(Ta = 25°C)

Item	Symbol	Conditions	Min.	Typ.	Max.	Unit
Reverse voltage	V <sub>R</sub>	I <sub>R</sub> = 1μA	30.0			V
Reverse current	I <sub>R</sub>	V <sub>R</sub> = 25V			10.0	nA
Diode capacitance	C <sub>1</sub>	V <sub>R</sub> = 1V, f = 1MHz	7.84		9.44	pF
	C <sub>25</sub>	V <sub>R</sub> = 25V, f = 1MHz	0.54		0.64	pF
Capacitance ratio	C <sub>1</sub> /C <sub>25</sub>		12.2	14.6		
Series resistance	r <sub>s</sub>	V <sub>R</sub> = 5V, f = 470MHz		1.30	1.50	Ω
Capacitance deviation in a matching group	ΔC	V <sub>R</sub> = 1 to 25V, f = 1MHz			6.0	%

Sony reserves the right to change products and specifications without prior notice. This information does not convey any license by any implication or otherwise under any patents or other right. Application circuits shown, if any, are typical examples illustrating the operation of the devices. Sony cannot assume responsibility for any problems arising out of the use of these circuits.

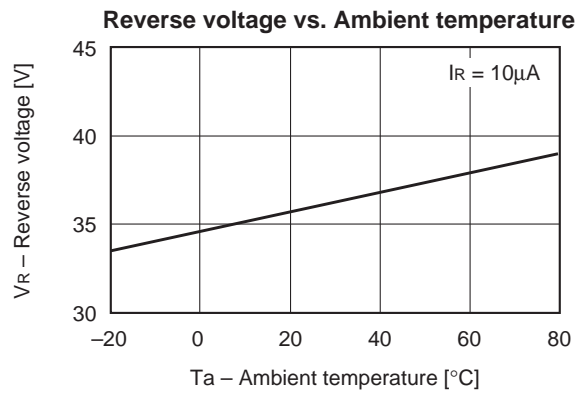
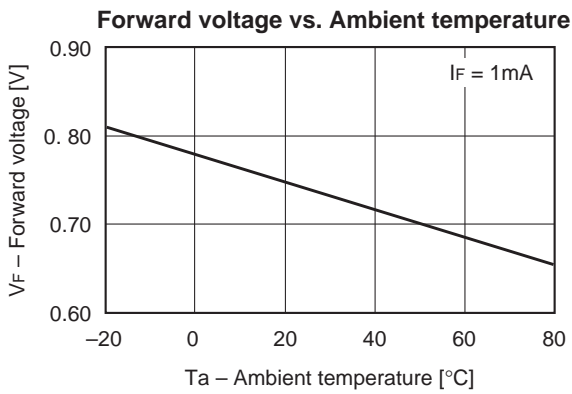
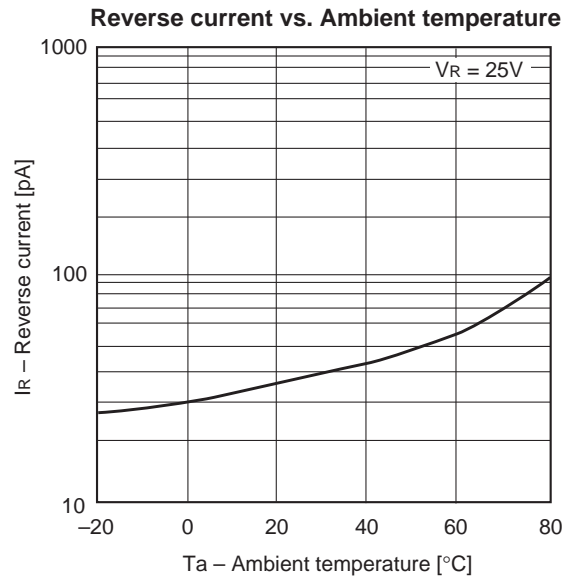
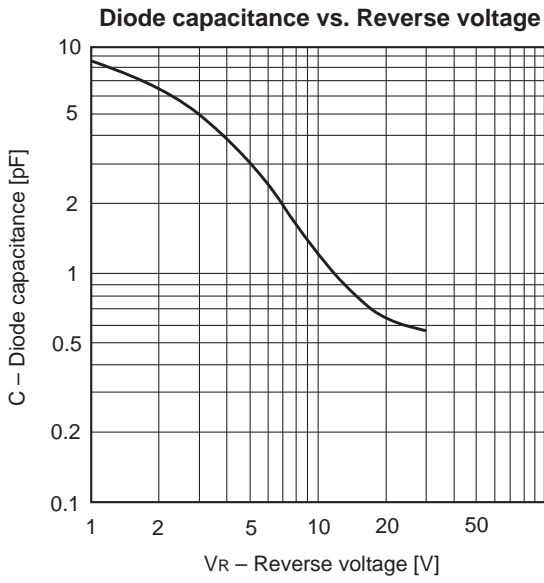

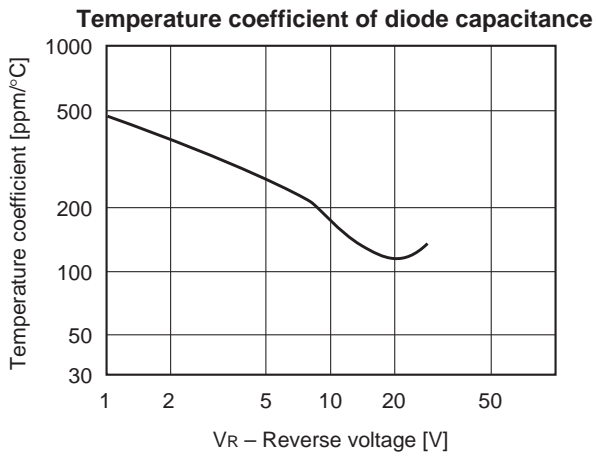
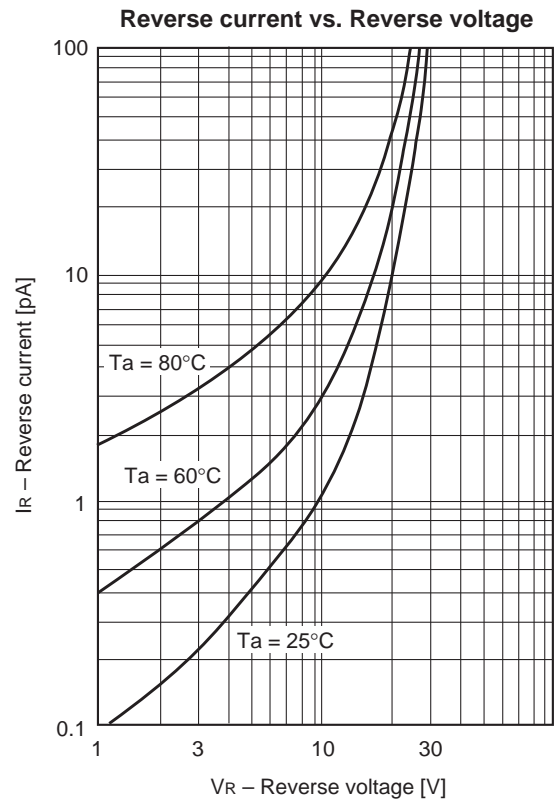
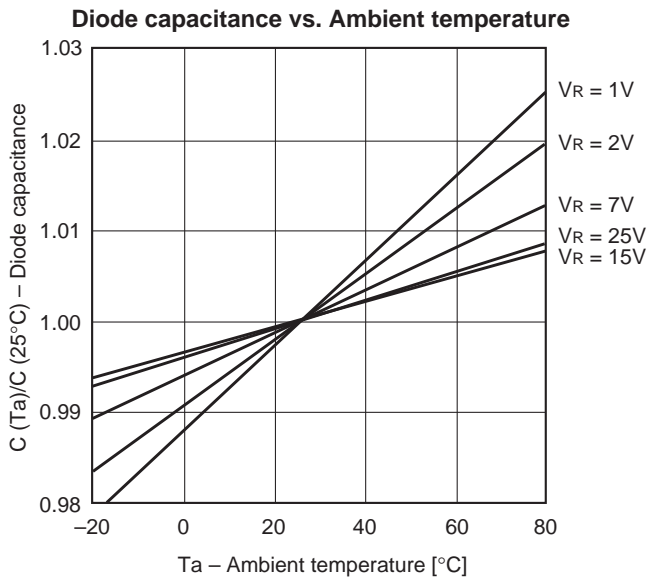

Package Outline

Unit: mm

M-235

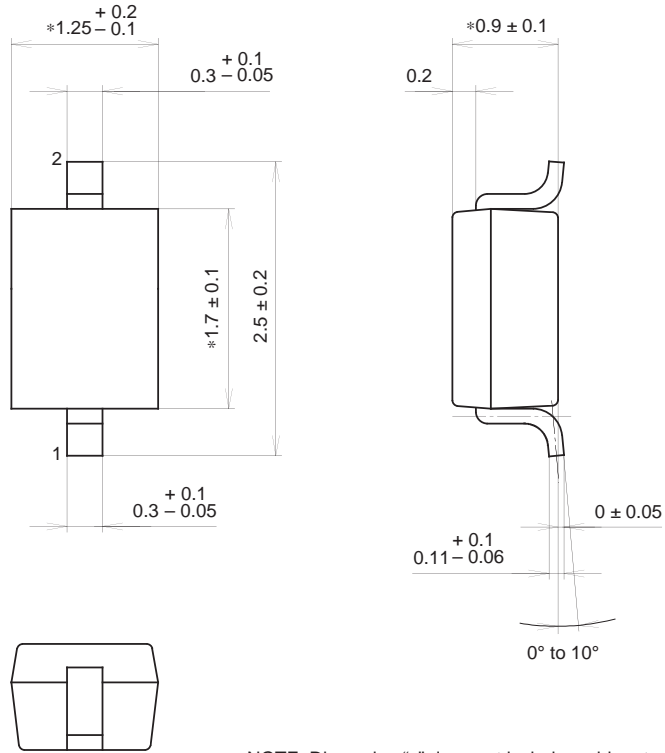

NOTE: Dimension "\*" does not include mold protrusion.

SONY CODE	M-235
EIAJ CODE	_____
JEDEC CODE	_____

PACKAGE WEIGHT	0.1g
----------------	------

Marking

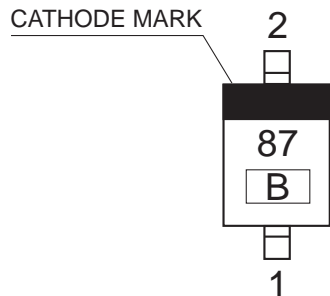

Note  
 B: Lot No. (Year and Month of manufacture)  
 Year; Last one digit  
 Month; A, B, C (for Oct. to Dec.)  
 1 to 9 (for Jan. to Sept.)