

High Voltage Transistors

MAXIMUM RATINGS

Rating	Symbol	2N6515	2N6517 2N6520	Unit
Collector–Emitter Voltage	V_{CEO}	250	350	Vdc
Collector–Base Voltage	V_{CBO}	250	350	Vdc
Emitter–Base Voltage 2N6515, 2N6516, 2N6517 2N6519, 2N6520	V_{EBO}	6.0 5.0		Vdc
Base Current	I_B	250		mAdc
Collector Current – Continuous	I_C	500		mAdc
Total Device Dissipation @ $T_A = 25^\circ\text{C}$ Derate above 25°C	P_D	625 5.0		mW mW/ $^\circ\text{C}$
Total Device Dissipation @ $T_C = 25^\circ\text{C}$ Derate above 25°C	P_D	1.5 12		Watts mW/ $^\circ\text{C}$
Operating and Storage Junction Temperature Range	T_J, T_{stg}	–55 to +150		$^\circ\text{C}$

THERMAL CHARACTERISTICS

Characteristic	Symbol	Max	Unit
Thermal Resistance, Junction to Ambient	$R_{\theta JA}$	200	$^\circ\text{C}/\text{W}$
Thermal Resistance, Junction to Case	$R_{\theta JC}$	83.3	$^\circ\text{C}/\text{W}$

NPN
2N6515
2N6517
PNP
2N6520

Voltage and current are negative
for PNP transistors

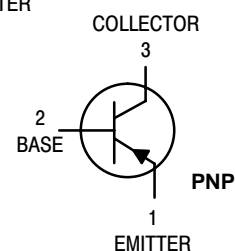
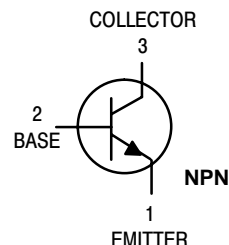
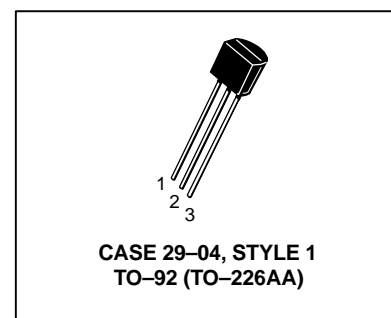

ELECTRICAL CHARACTERISTICS ($T_A = 25^\circ\text{C}$ unless otherwise noted)

Characteristic	Symbol	Min	Max	Unit
----------------	--------	-----	-----	------

OFF CHARACTERISTICS

Collector–Emitter Breakdown Voltage ⁽¹⁾ ($I_C = 1.0 \text{ mAdc}, I_B = 0$)	$V_{(BR)CEO}$	250 350	– –	Vdc
Collector–Base Breakdown Voltage ($I_C = 100 \mu\text{Adc}, I_E = 0$)	$V_{(BR)CBO}$	250 350	– –	Vdc
Emitter–Base Breakdown Voltage ($I_E = 10 \mu\text{Adc}, I_C = 0$)	$V_{(BR)EBO}$	6.0 5.0	– –	Vdc

1. Pulse Test: Pulse Width $\leq 300 \mu\text{s}$, Duty Cycle $\leq 2.0\%$.

NPN 2N6515 2N6517 PNP 2N6520

ELECTRICAL CHARACTERISTICS ($T_A = 25^\circ\text{C}$ unless otherwise noted) (Continued)

Characteristic	Symbol	Min	Max	Unit
OFF CHARACTERISTICS (Continued)				
Collector Cutoff Current ($V_{CB} = 150\text{ Vdc}$, $I_E = 0$) ($V_{CB} = 250\text{ Vdc}$, $I_E = 0$)	I_{CBO}	–	50 50	nAdc
Emitter Cutoff Current ($V_{EB} = 5.0\text{ Vdc}$, $I_C = 0$) ($V_{EB} = 4.0\text{ Vdc}$, $I_C = 0$)	I_{EBO}	–	50 50	nAdc

ON CHARACTERISTICS(1)

DC Current Gain ($I_C = 1.0\text{ mAdc}$, $V_{CE} = 10\text{ Vdc}$) ($I_C = 10\text{ mAdc}$, $V_{CE} = 10\text{ Vdc}$) ($I_C = 30\text{ mAdc}$, $V_{CE} = 10\text{ Vdc}$) ($I_C = 50\text{ mAdc}$, $V_{CE} = 10\text{ Vdc}$) ($I_C = 100\text{ mAdc}$, $V_{CE} = 10\text{ Vdc}$)	2N6515 2N6517, 2N6520 2N6515 2N6517, 2N6520 2N6515 2N6517, 2N6520 2N6515 2N6517, 2N6520 2N6515 2N6517, 2N6520	h_{FE}	35 20 50 30 50 30 45 20 25 15	– – – 300 200 – – –	–
Collector–Emitter Saturation Voltage ($I_C = 10\text{ mAdc}$, $I_B = 1.0\text{ mAdc}$) ($I_C = 20\text{ mAdc}$, $I_B = 2.0\text{ mAdc}$) ($I_C = 30\text{ mAdc}$, $I_B = 3.0\text{ mAdc}$) ($I_C = 50\text{ mAdc}$, $I_B = 5.0\text{ mAdc}$)		$V_{CE(sat)}$	– – – –	0.30 0.35 0.50 1.0	Vdc
Base–Emitter Saturation Voltage ($I_C = 10\text{ mAdc}$, $I_B = 1.0\text{ mAdc}$) ($I_C = 20\text{ mAdc}$, $I_B = 2.0\text{ mAdc}$) ($I_C = 30\text{ mAdc}$, $I_B = 3.0\text{ mAdc}$)		$V_{BE(sat)}$	– – –	0.75 0.85 0.90	Vdc
Base–Emitter On Voltage ($I_C = 100\text{ mAdc}$, $V_{CE} = 10\text{ Vdc}$)		$V_{BE(on)}$	–	2.0	Vdc

SMALL–SIGNAL CHARACTERISTICS

Current–Gain – Bandwidth Product(1) ($I_C = 10\text{ mAdc}$, $V_{CE} = 20\text{ Vdc}$, $f = 20\text{ MHz}$)		f_T	40	200	MHz
Collector–Base Capacitance ($V_{CB} = 20\text{ Vdc}$, $I_E = 0$, $f = 1.0\text{ MHz}$)		C_{cb}	–	6.0	pF
Emitter–Base Capacitance ($V_{EB} = 0.5\text{ Vdc}$, $I_C = 0$, $f = 1.0\text{ MHz}$)	2N6515, 2N6517 2N6520	C_{eb}	– –	80 100	pF

SWITCHING CHARACTERISTICS

Turn–On Time ($V_{CC} = 100\text{ Vdc}$, $V_{BE(off)} = 2.0\text{ Vdc}$, $I_C = 50\text{ mAdc}$, $I_{B1} = 10\text{ mAdc}$)		t_{on}	–	200	μs
Turn–Off Time ($V_{CC} = 100\text{ Vdc}$, $I_C = 50\text{ mAdc}$, $I_{B1} = I_{B2} = 10\text{ mAdc}$)		t_{off}	–	3.5	μs

1. Pulse Test: Pulse Width $\leq 300\ \mu\text{s}$, Duty Cycle $\leq 2.0\%$.

NPN 2N6515 2N6517 PNP 2N6520

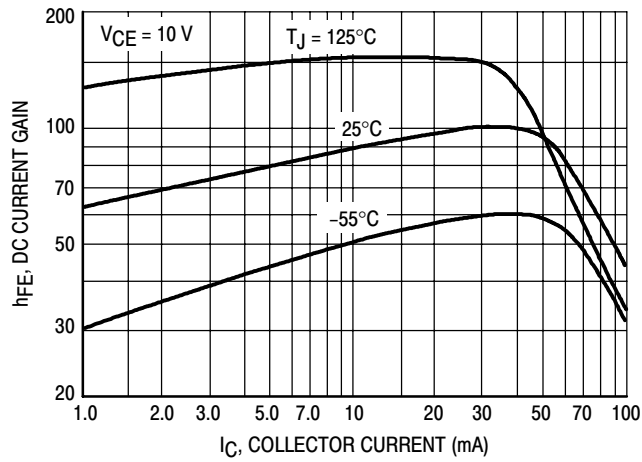

Figure 1. DC Current Gain – NPN 2N6515

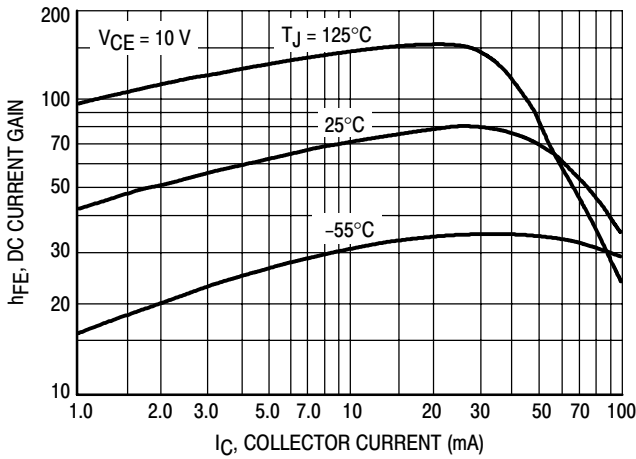

Figure 2. DC Current Gain – NPN 2N6517

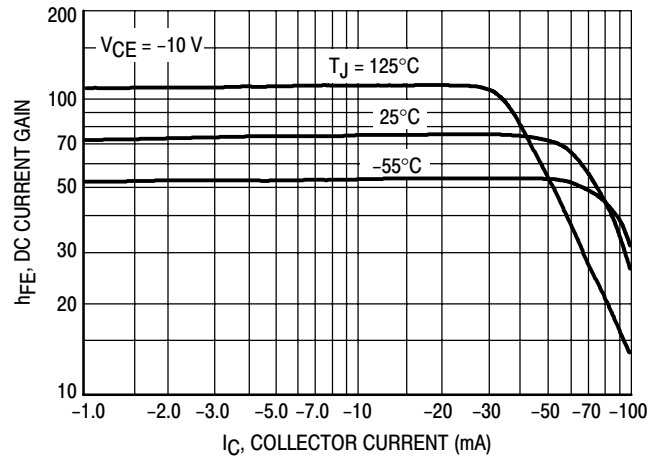

Figure 3. DC Current Gain – PNP 2N6520

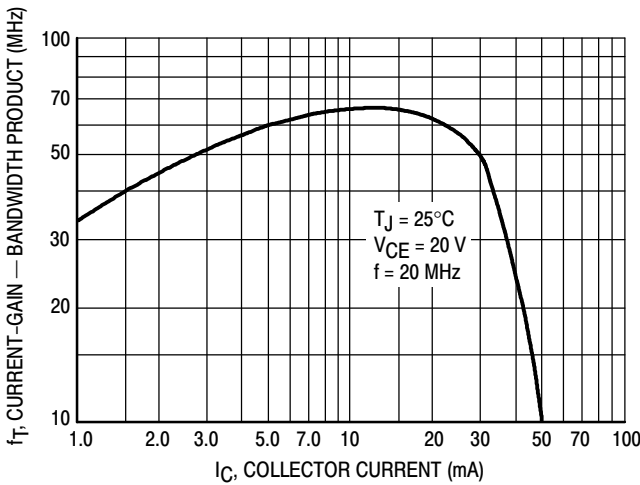

Figure 4. Current-Gain – Bandwidth Product – NPN 2N6515, 2N6517

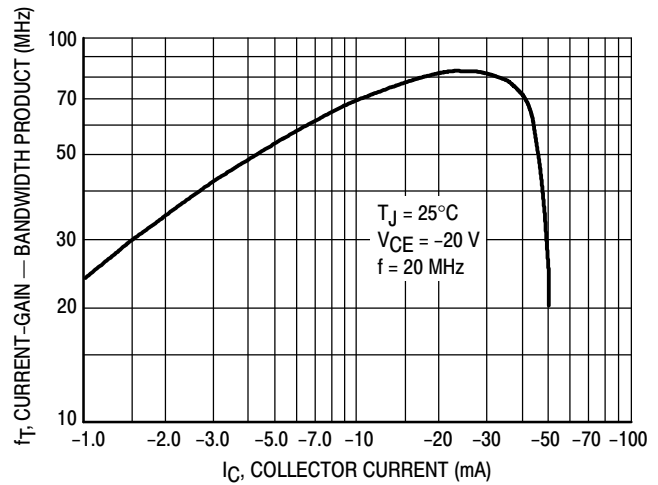

Figure 5. Current-Gain – Bandwidth Product – PNP 2N6520

NPN 2N6515 2N6517 PNP 2N6520

NPN

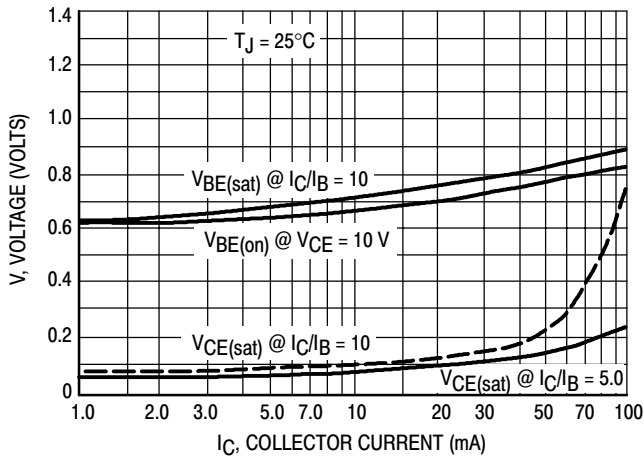

Figure 6. "On" Voltages – NPN 2N6515, 2N6517

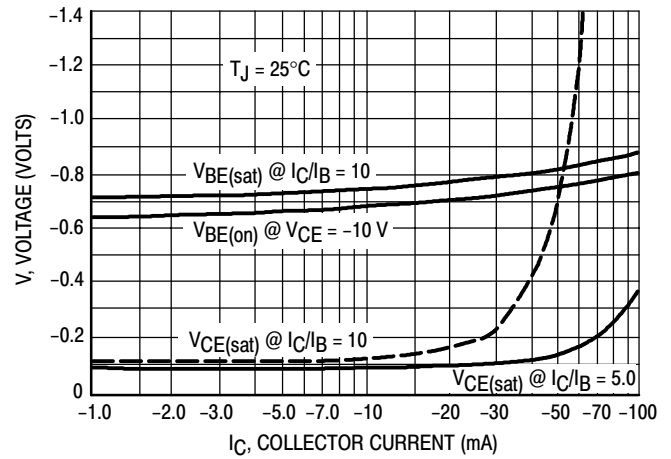

Figure 7. "On" Voltages – PNP 2N6520

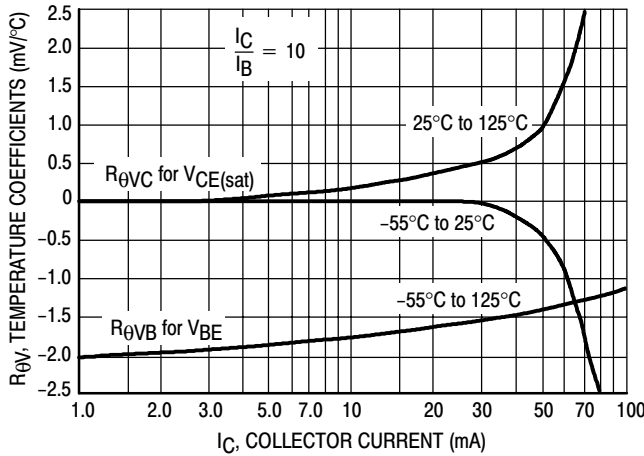

Figure 8. Temperature Coefficients – NPN 2N6515, 2N6517

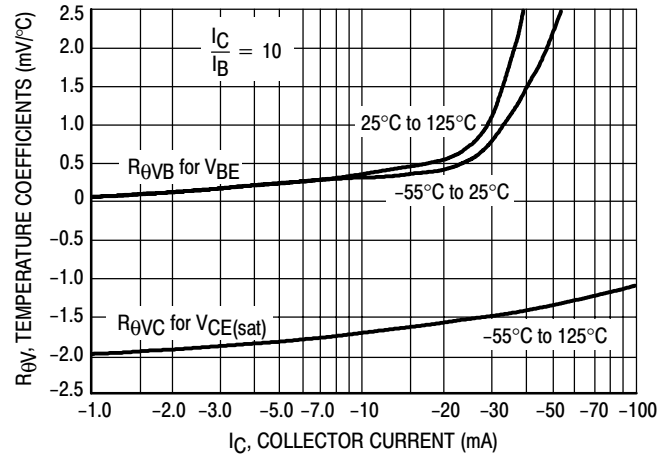

Figure 9. Temperature Coefficients – PNP 2N6520

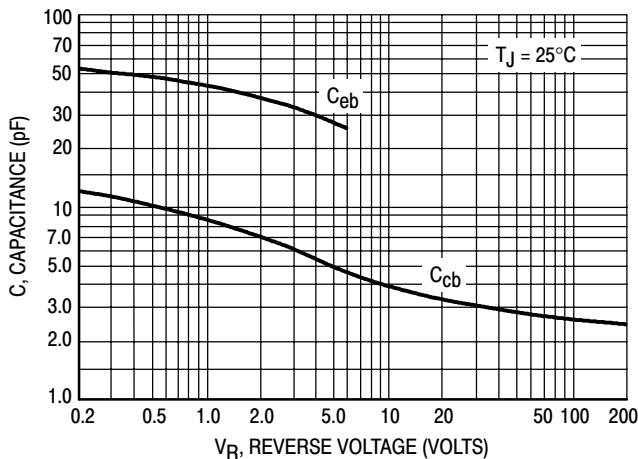

Figure 10. Capacitance – NPN 2N6515, 2N6517

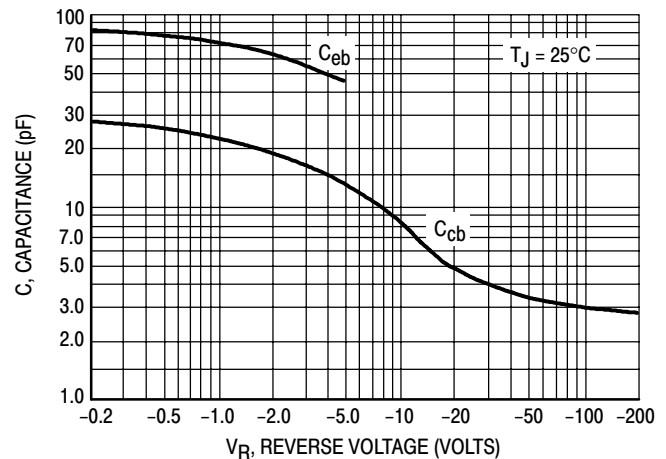

Figure 11. Capacitance – PNP 2N6520

NPN 2N6515 2N6517 PNP 2N6520

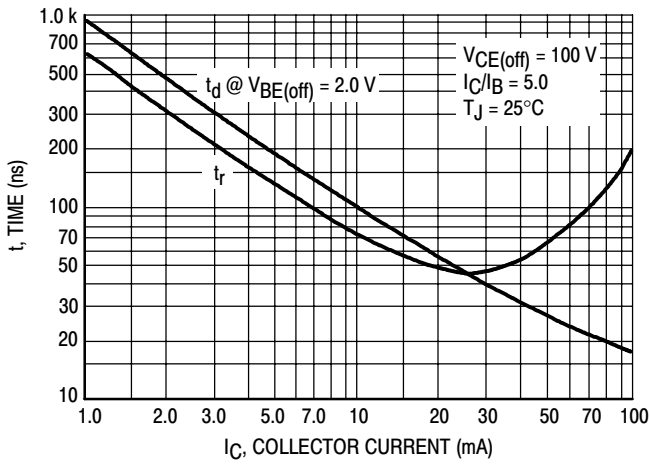

Figure 12. Turn-On Time – NPN 2N6515, 2N6517

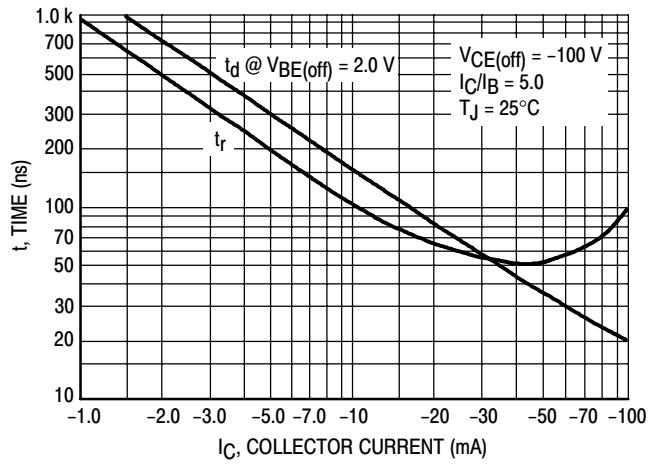

Figure 13. Turn-On Time – PNP 2N6520

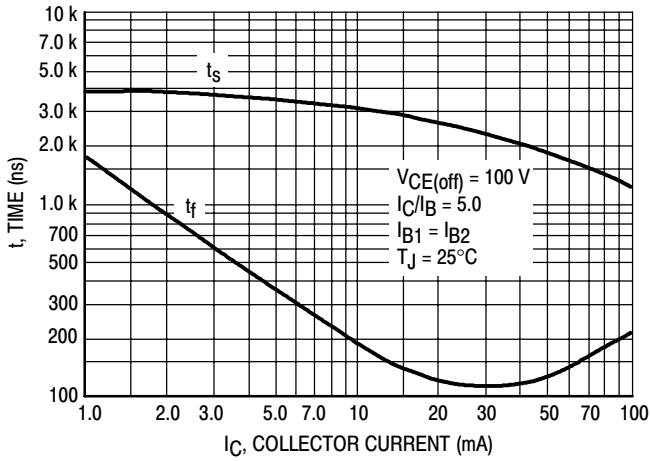

Figure 14. Turn-Off Time – NPN 2N6515, 2N6517

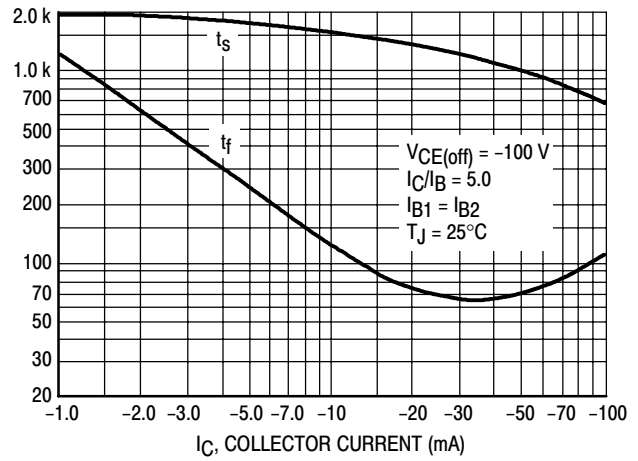

Figure 15. Turn-Off Time – PNP 2N6520

NPN 2N6515 2N6517 PNP 2N6520

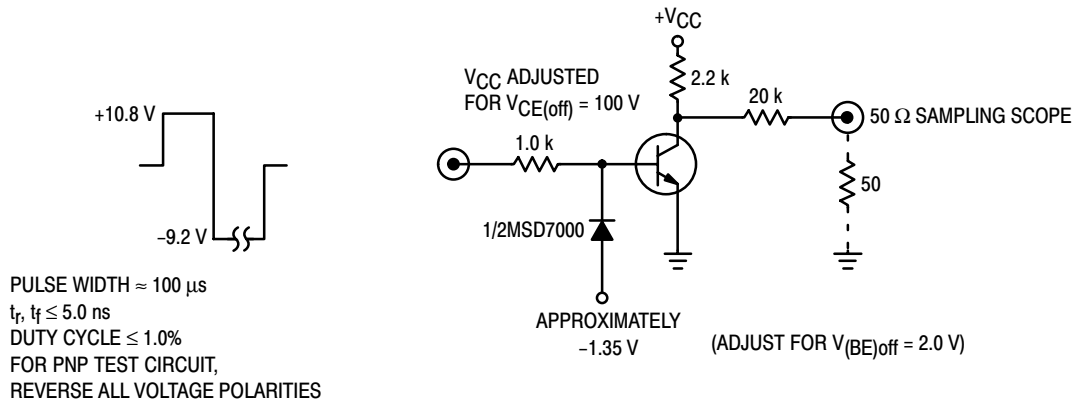

Figure 16. Switching Time Test Circuit

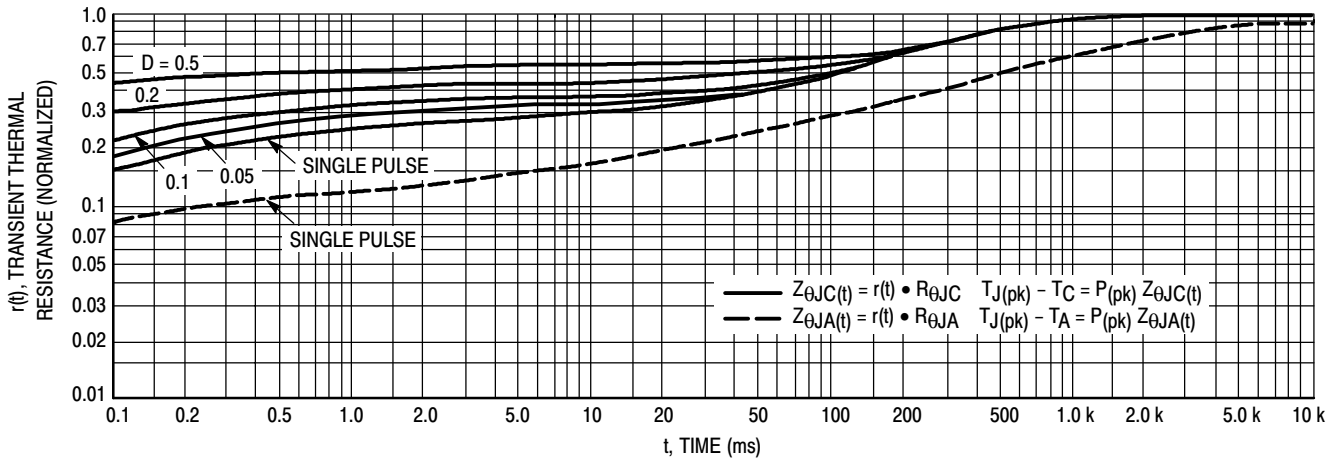

Figure 17. Thermal Response

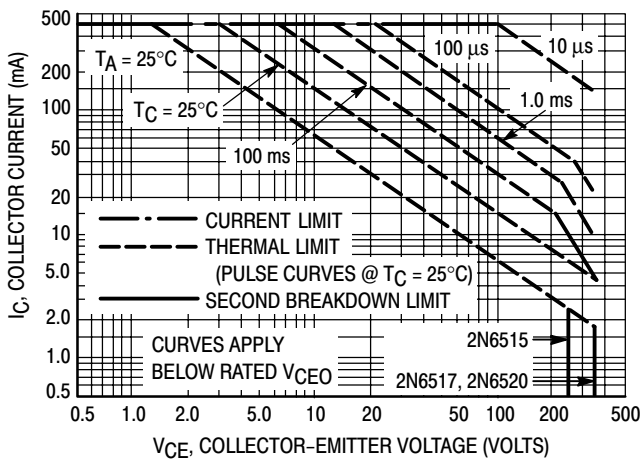
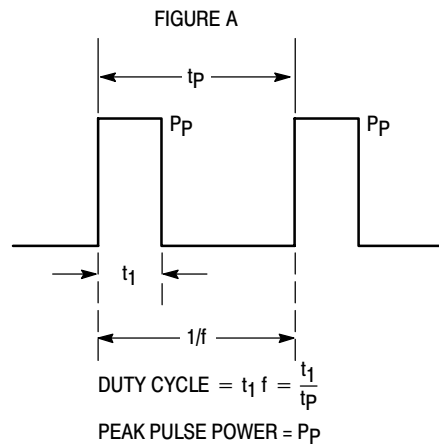

Figure 18. Active Region Safe Operating Area



Design Note: Use of Transient Thermal Resistance Data

NPN 2N6515 2N6517 PNP 2N6520

PACKAGE DIMENSIONS

CASE 029-04
(TO-226AA)
ISSUE AD

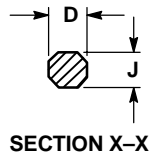
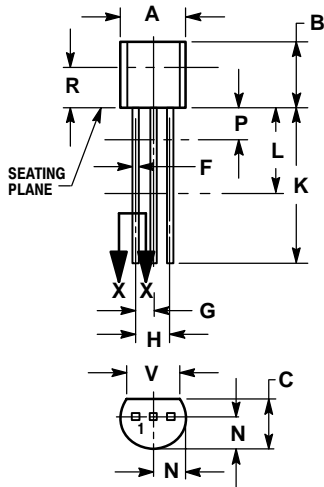

NOTES:

1. DIMENSIONING AND TOLERANCING PER ANSI Y14.5M, 1982.
2. CONTROLLING DIMENSION: INCH.
3. CONTOUR OF PACKAGE BEYOND DIMENSION R IS UNCONTROLLED.
4. DIMENSION F APPLIES BETWEEN P AND L. DIMENSION D AND J APPLY BETWEEN L AND K MINIMUM. LEAD DIMENSION IS UNCONTROLLED IN P AND BEYOND DIMENSION K MINIMUM.

DIM	INCHES		MILLIMETERS	
	MIN	MAX	MIN	MAX
A	0.175	0.205	4.45	5.20
B	0.170	0.210	4.32	5.33
C	0.125	0.165	3.18	4.19
D	0.016	0.022	0.41	0.55
F	0.016	0.019	0.41	0.48
G	0.045	0.055	1.15	1.39
H	0.095	0.105	2.42	2.66
J	0.015	0.020	0.39	0.50
K	0.500	----	12.70	----
L	0.250	----	6.35	----
N	0.080	0.105	2.04	2.66
P	----	0.100	----	2.54
R	0.115	----	2.93	----
V	0.135	----	3.43	----

STYLE 1:

1. PIN 1. EMITTER
2. BASE
3. COLLECTOR

ON Semiconductor and  are trademarks of Semiconductor Components Industries, LLC (SCILLC). SCILLC reserves the right to make changes without further notice to any products herein. SCILLC makes no warranty, representation or guarantee regarding the suitability of its products for any particular purpose, nor does SCILLC assume any liability arising out of the application or use of any product or circuit, and specifically disclaims any and all liability, including without limitation special, consequential or incidental damages. "Typical" parameters which may be provided in SCILLC data sheets and/or specifications can and do vary in different applications and actual performance may vary over time. All operating parameters, including "Typicals" must be validated for each customer application by customer's technical experts. SCILLC does not convey any license under its patent rights nor the rights of others. SCILLC products are not designed, intended, or authorized for use as components in systems intended for surgical implant into the body, or other applications intended to support or sustain life, or for any other application in which the failure of the SCILLC product could create a situation where personal injury or death may occur. Should Buyer purchase or use SCILLC products for any such unintended or unauthorized application, Buyer shall indemnify and hold SCILLC and its officers, employees, subsidiaries, affiliates, and distributors harmless against all claims, costs, damages, and expenses, and reasonable attorney fees arising out of, directly or indirectly, any claim of personal injury or death associated with such unintended or unauthorized use, even if such claim alleges that SCILLC was negligent regarding the design or manufacture of the part. SCILLC is an Equal Opportunity/Affirmative Action Employer.

PUBLICATION ORDERING INFORMATION

Literature Fulfillment:

Literature Distribution Center for ON Semiconductor
P.O. Box 5163, Denver, Colorado 80217 USA
Phone: 303-675-2175 or 800-344-3860 Toll Free USA/Canada
Fax: 303-675-2176 or 800-344-3867 Toll Free USA/Canada
Email: ONlit@hibbertco.com

N. American Technical Support: 800-282-9855 Toll Free USA/Canada

JAPAN: ON Semiconductor, Japan Customer Focus Center
4-32-1 Nishi-Gotanda, Shinagawa-ku, Tokyo, Japan 141-0031
Phone: 81-3-5740-2700
Email: r14525@onsemi.com

ON Semiconductor Website: <http://onsemi.com>

For additional information, please contact your local Sales Representative.