

# 2SB1297

Silicon PNP epitaxial planer type

For low-frequency output amplification

Complementary to 2SD1937

## ■ Features

- Extremely satisfactory linearity of the forward current transfer ratio  $h_{FE}$ .
- High transition frequency  $f_T$ .
- Makes up a complementary pair with 2SD1937, which is optimum for the pre-driver stage of a 40 to 60W output amplifier.

## ■ Absolute Maximum Ratings (Ta=25°C)

Parameter	Symbol	Ratings	Unit
Collector to base voltage	$V_{CBO}$	-120	V
Collector to emitter voltage	$V_{CEO}$	-120	V
Emitter to base voltage	$V_{EBO}$	-5	V
Peak collector current	$I_{CP}$	-1	A
Collector current	$I_C$	-0.5	A
Collector power dissipation	$P_C$	1	W
Junction temperature	$T_j$	150	°C
Storage temperature	$T_{stg}$	-55 ~ +150	°C

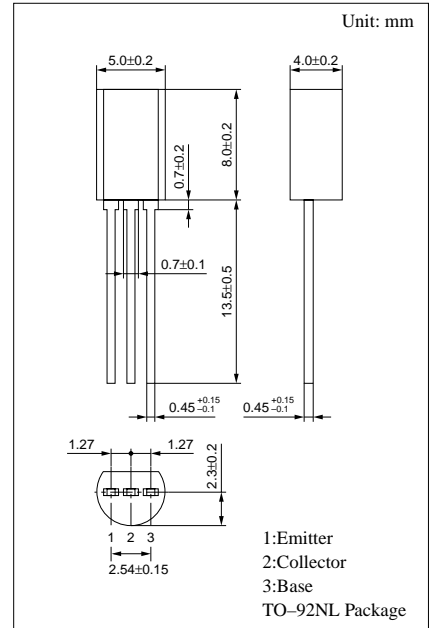

## ■ Electrical Characteristics (Ta=25°C)

Parameter	Symbol	Conditions	min	typ	max	Unit
Collector to emitter voltage	$V_{CEO}$	$I_C = -0.1mA, I_B = 0$	-120			V
Emitter to base voltage	$V_{EBO}$	$I_E = -10\mu A, I_C = 0$	-5			V
Forward current transfer ratio	$h_{FE1}^{*1}$	$V_{CE} = -10V, I_C = -150mA^{*2}$	90		220	
	$h_{FE2}$	$V_{CE} = -5V, I_C = -500mA^{*2}$	50			
Collector to emitter saturation voltage	$V_{CE(sat)}$	$I_C = -300mA, I_B = -30mA^{*2}$			-1.0	V
Base to emitter saturation voltage	$V_{BE(sat)}$	$I_C = -300mA, I_B = -30mA^{*2}$			-1.2	V
Transition frequency	$f_T$	$V_{CB} = -10V, I_E = 50mA, f = 200MHz$		250		MHz
Collector output capacitance	$C_{ob}$	$V_{CB} = -10V, I_E = 0, f = 1MHz$			30	pF

\*2 Pulse measurement

\*1  $h_{FE1}$  Rank classification

Rank	Q	R
$h_{FE1}$	90 ~ 155	130 ~ 220

$P_C - T_a$

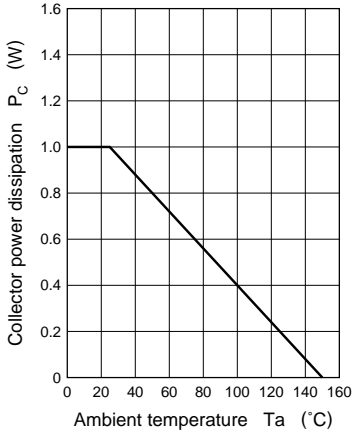

$I_C - V_{CE}$

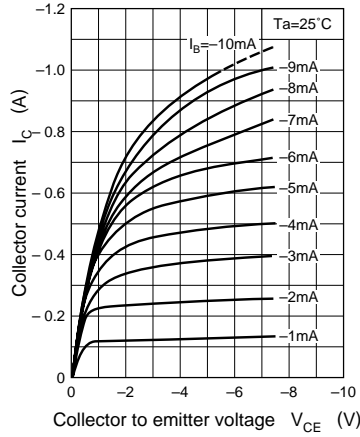

$h_{FE} - I_C$

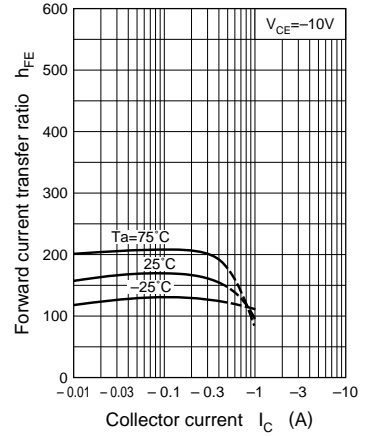

$V_{BE(sat)} - I_C$

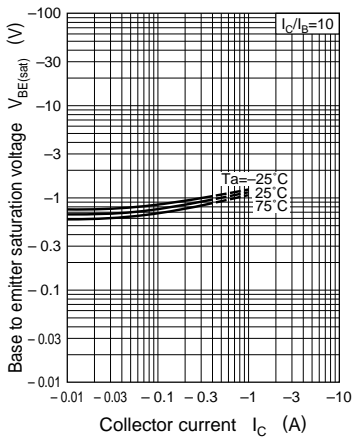

$V_{CE(sat)} - I_C$

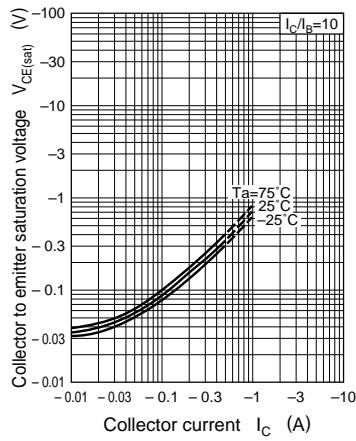

$f_T - I_E$

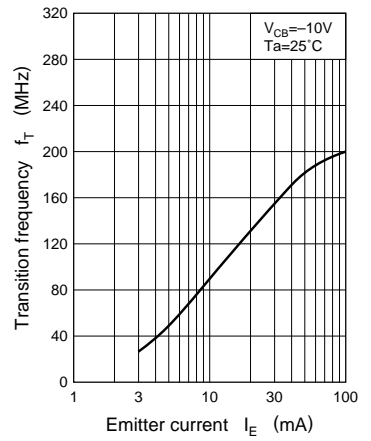

$C_{ob} - V_{CB}$

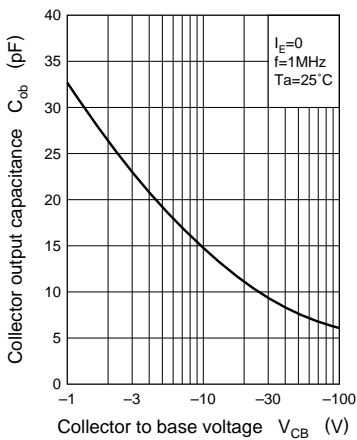

Area of safe operation (ASO)

