

SPECIFICATION

DEVICE NAME : Power MOSFET

TYPE NAME : 2SK2954-MR

SPEC. No. : - - -

Fuji Electric Co., Ltd.
Matsumoto Factory

This material and the information herein is the property of Fuji Electric Co., Ltd. They shall be neither reproduced, copied, lent, or disclosed in any way whatsoever for the use of any third party nor used for the manufacturing purposes without the express written consent of Fuji Electric Co., Ltd.

	DATE	NAME	APPROVED	Fuji Electric Co., Ltd.	
DRAWN				DWG. NO.	1/10
CHECKED					

1. Scope
This specifies Fuji power MOSFET 2SK2954-MR
2. Construction N-channel enhancement mode power MOSFET
3. Application for switching
4. Outview T0-220F Outview See to 4/10 page
5. Absolute maximum ratings at $T_c=25^\circ\text{C}$ (unless otherwise specified)

Description	Symbol	Characteristics	Unit	
Drain-source voltage	V_{DS}	100	V	
Drain-gate voltage	V_{DGR}	100	V	
Continuous Drain current	I_D	± 30	A	
Pulsed drain current	$I_{Dpulsec}$	± 120	A	
Gate-source voltage	V_{GS}	± 20	V	
Maximum power dissipation	P_D	50	W	
Operating and storage temperature range	T_{ch}	150	$^\circ\text{C}$	
	T_{stg}	-55 ~ +150	$^\circ\text{C}$	

6. Electrical characteristics at $T_c=25^\circ\text{C}$ (unless otherwise specified)
Static ratings

Description	Symbol	Conditions	Characteristics			Unit	
			Min.	Typ.	Max.		
Drain-source breakdown voltage	BV_{DSS}	$I_D = 1\text{mA}$ $V_{GS} = 0\text{V}$	100			V	
Gate threshold voltage	$V_{GS(th)}$	$I_D = 1\text{mA}$ $V_{DS} = V_{GS}$	1.0	1.5	2.5	V	
Zero gate voltage drain current	I_{DSS}	$V_{DS} = 100\text{V}$ $V_{GS} = 0\text{V}$	$T_{ch} = 25^\circ\text{C}$		10	500	μA
	I_{DSS}		$T_{ch} = 125^\circ\text{C}$		0.2	1.0	mA
Gate-source leakage current	I_{GSS}	$V_{GS} = \pm 20\text{V}$ $V_{DS} = 0\text{V}$		10	100	nA	
Drain-source on-state resistance	$R_{DS(on)}$	$I_D = 15\text{A}$	$V_{GS} = 4\text{V}$	40	70	m Ω	
			$V_{GS} = 10\text{V}$	30	55		

This material and the information herein is the property of Fuji Electric Co., Ltd. They shall be neither reproduced, copied, lent, or disclosed in any way whatsoever for the use of any third party nor used for the manufacturing purposes without the express written consent of Fuji Electric Co., Ltd.

Dynamic ratings

Description	Symbol	Conditions	Characteristics			Unit
			Min.	Typ.	Max.	
Forward transconductance	g_{fs}	$I_o = 15A$ $V_{os} = 25V$	15	30		S
Input capacitance	C_{iss}	$V_{os} = 25V$ $V_{cs} = 0V$ $f = 1MHz$		2500	3700	pF
Output capacitance	C_{oss}			500	750	pF
Reverse transfer capacitance	C_{rss}			250	380	pF
Turn-on time	$t_{d(on)}$	$V_{cc} = 30V$ $V_{gs} = 10V$ $I_o = 30A$ $R_{gs} = 25\Omega$		20	30	ns
	t_r			140	210	ns
Turn-off time	$t_{d(off)}$			500	750	ns
	t_f			260	390	ns

Reverse diode

Description	Symbol	Conditions	Characteristics			Unit
			Min.	Typ.	Max.	
Diode forward on-voltage	V_{SD}	$I_F = 2 \times I_{DR}$ $V_{GS} = 0V, T_{ch} = 25^\circ C$		0.9	1.5	V
Reverse recovery time	t_{rr}	$I_F = I_{DR}$ $V_{GS} = 0V$ $-di_F/dt = 100A/\mu s$ $T_{ch} = 25^\circ C$		130		ns
Reverse recovery charge	Q_{rr}			1		μC

7. Thermal resistance

Description	Symbol	Conditions	Characteristics			Unit
			Min.	Typ.	Max.	
Thermal resistance	$R_{th_{ch-c}}$				2.5	$^\circ C/W$
	$R_{th_{ch-a}}$				62.5	$^\circ C/W$

This material and the information herein is the property of Fuji Electric Co., Ltd. They shall be neither reproduced, copied, lent, or disclosed in any way whatsoever for the use of any third party nor used for the manufacturing purposes without the express written consent of Fuji Electric Co., Ltd.

FUJI POWER MOS FET

TYPE : 2SK2954-MR

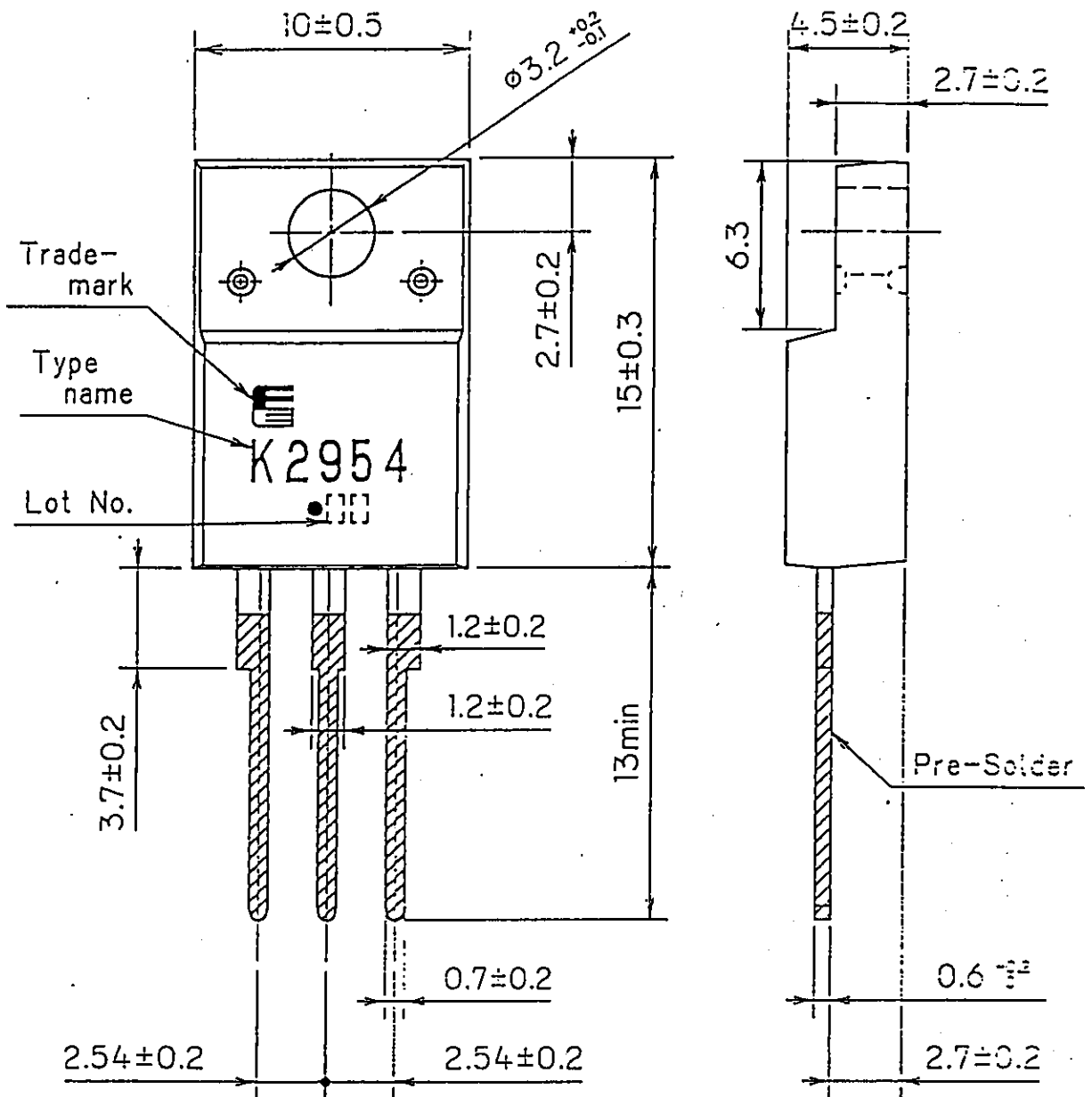

This material and the information herein is the property of Fuji Electric Co., Ltd. They shall be neither reproduced, copied, lent, or disclosed in any way whatsoever for the use of any third party nor used for the manufacturing purposes without the express written consent of Fuji Electric Co., Ltd.

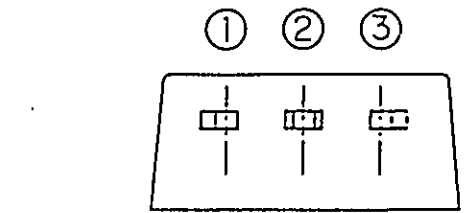

CONNECTION

- ① GATE
- ② DRAIN
- ③ SOURCE

DIMENSIONS ARE IN MILLIMETERS.

Fuji Electric Co., Ltd.

DWG. NO.

4/10

H04-004-03

Power Dissipation

$PD=f(T_c)$

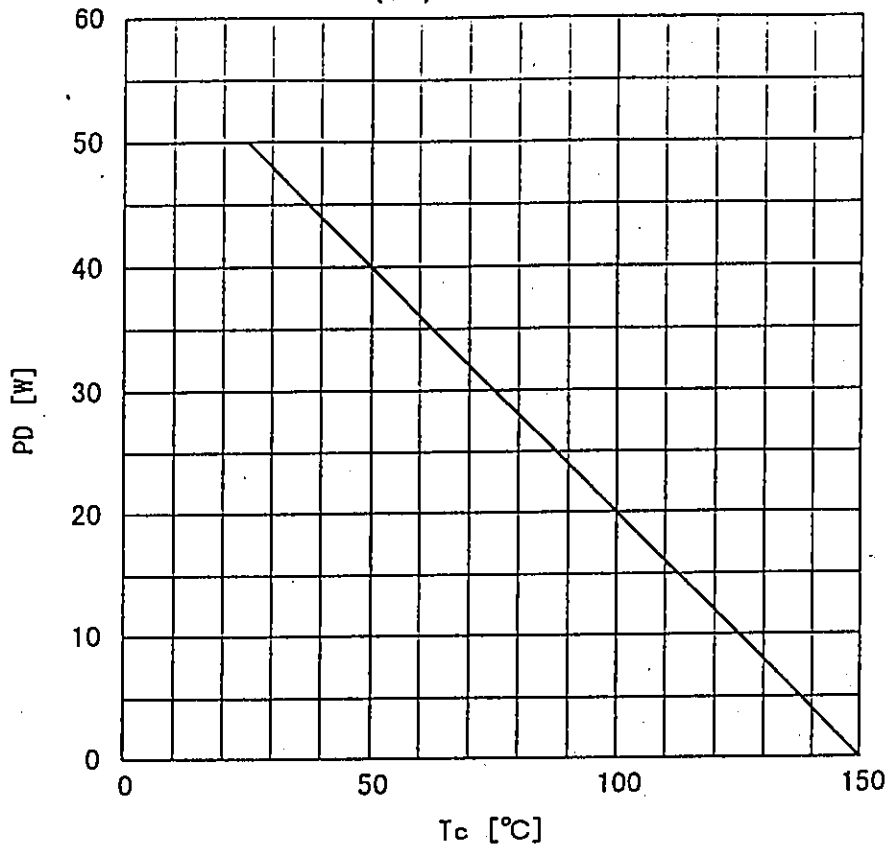

Safe operating area

$ID=f(V_{DS}) : D=0.01, T_c=25^\circ C$

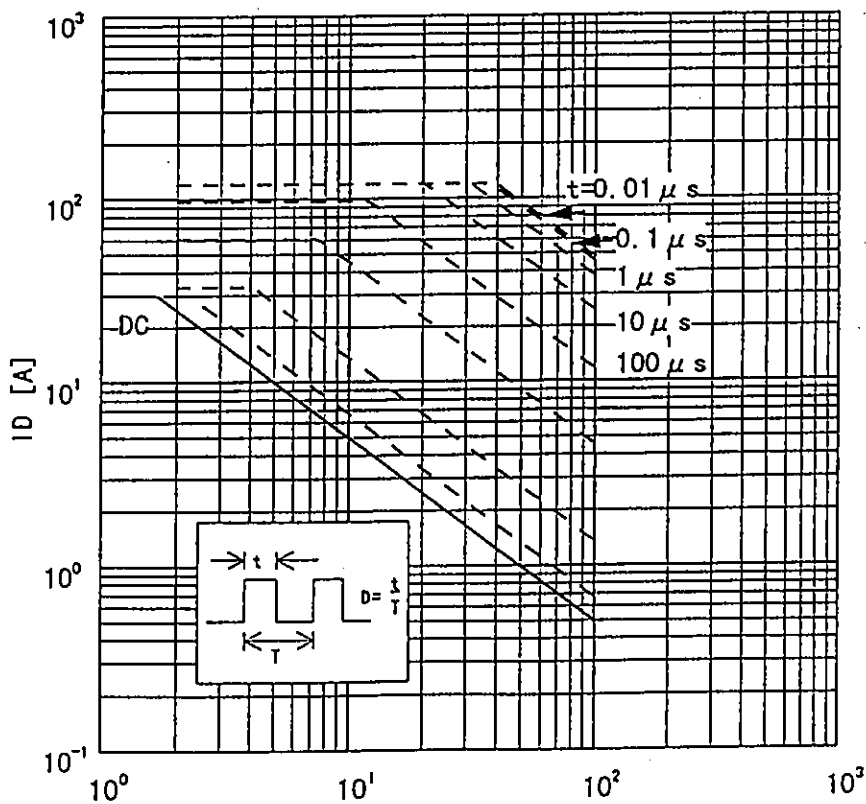

This material and the information herein is the property of Fuji Electric Co., Ltd. They shall be neither reproduced, copied, lent, or disclosed in any way whatsoever for the use of any third party nor used for the manufacturing purposes without the express written consent of Fuji Electric Co., Ltd.

Typical output characteristics
 $I_D = f(V_{DS})$: 80 μ s pulse test, $T_{ch} = 25^\circ\text{C}$

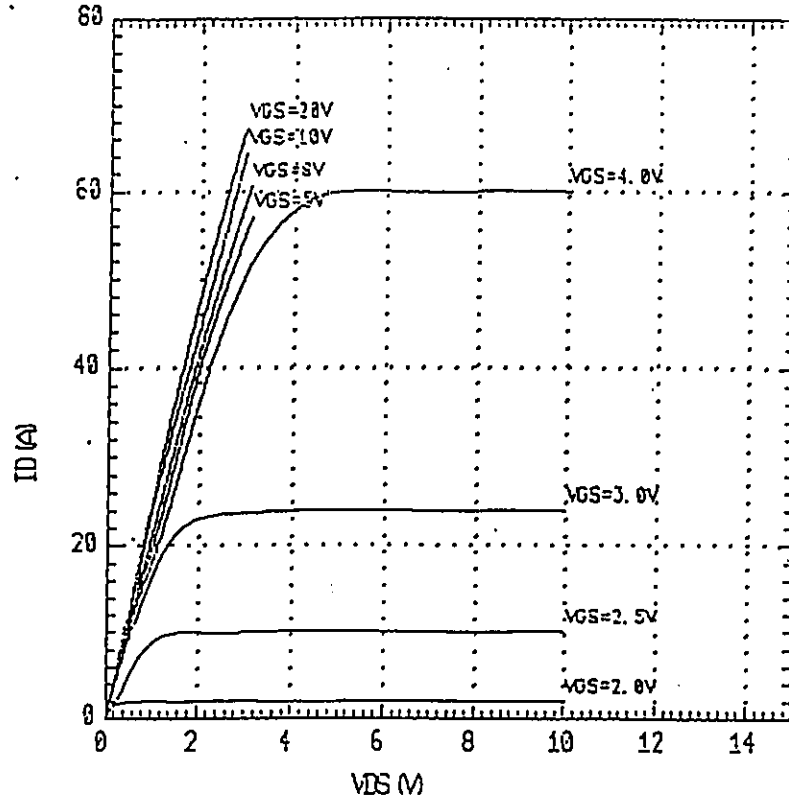

Typical Transfer Characteristics
 $I_D = f(V_{GS})$: 80 μ s pulse test, $V_{DS} = 25\text{V}$, $T_{ch} = 25^\circ\text{C}$

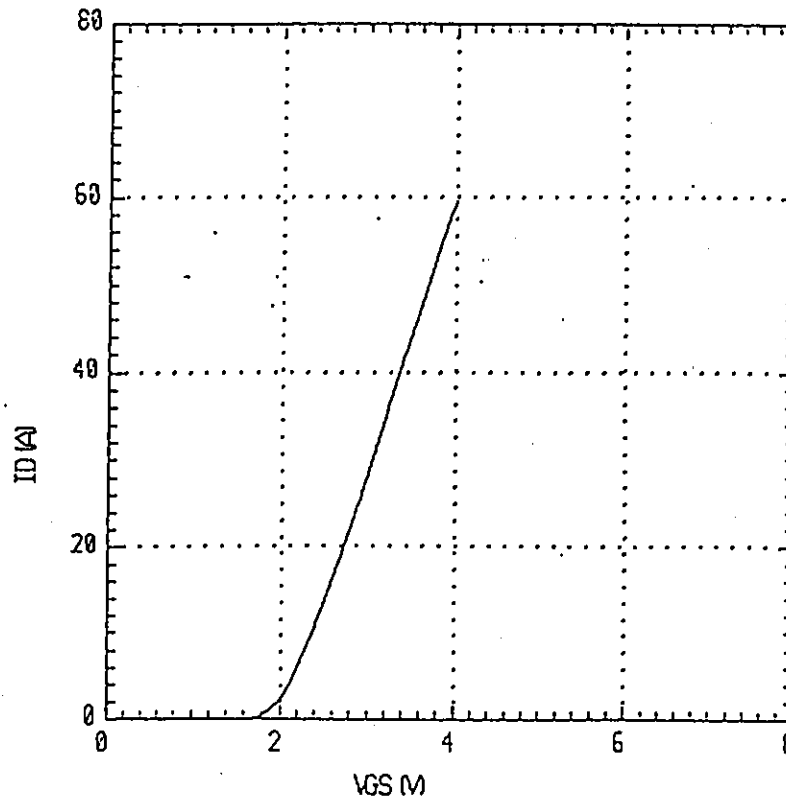

Typical Transconductance
 $g_{fs}=f(I_D): 80\mu s$ pulse test, $V_{DS}=25V, T_{ch}=25^\circ C$

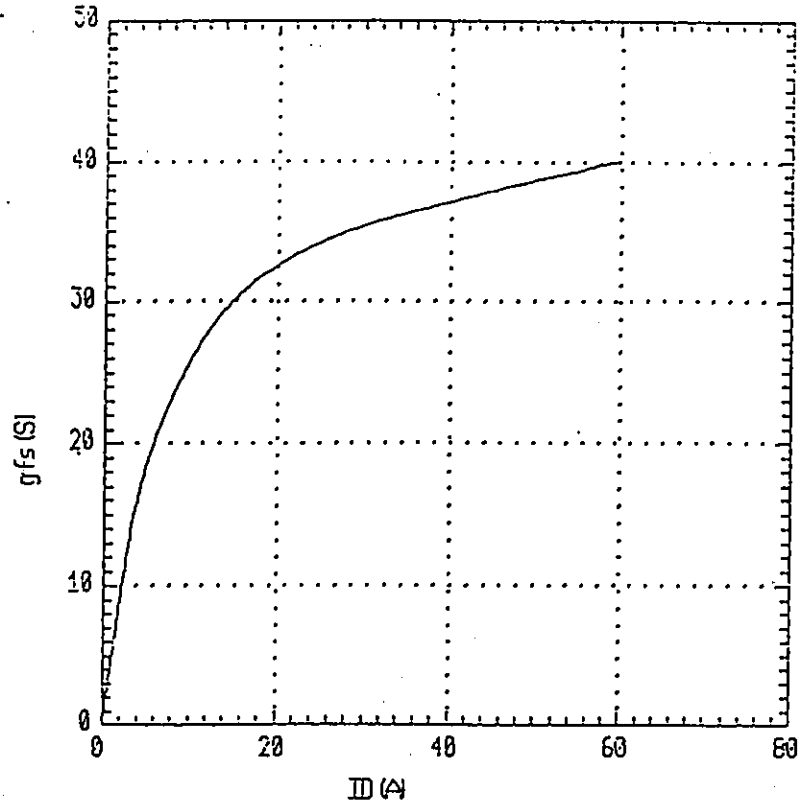

Typical Drain-source on-state resistance
 $R_{DS(on)}=f(I_D): 80\mu s$ pulse test, $T_{ch}=25^\circ C$

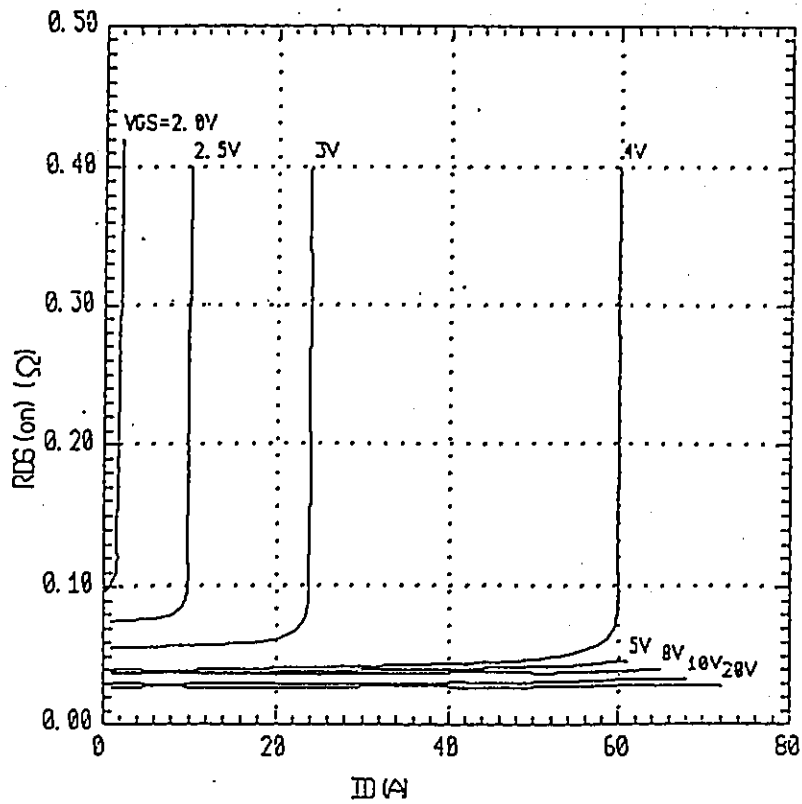

Drain-source on-state resistance
 $R_{DS(on)} = f(T_{ch}) : I_D = 15A, V_{GS} = 10V$

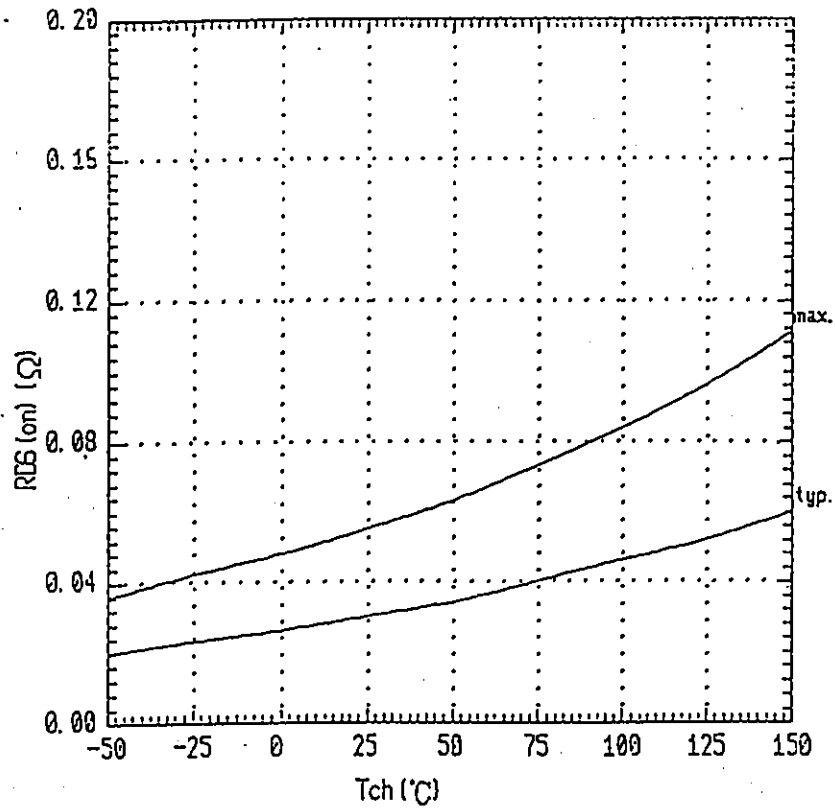

Gate threshold voltage
 $V_{GS(th)} = f(T_{ch}) : V_{DS} = V_{GS}, I_D = 1mA$

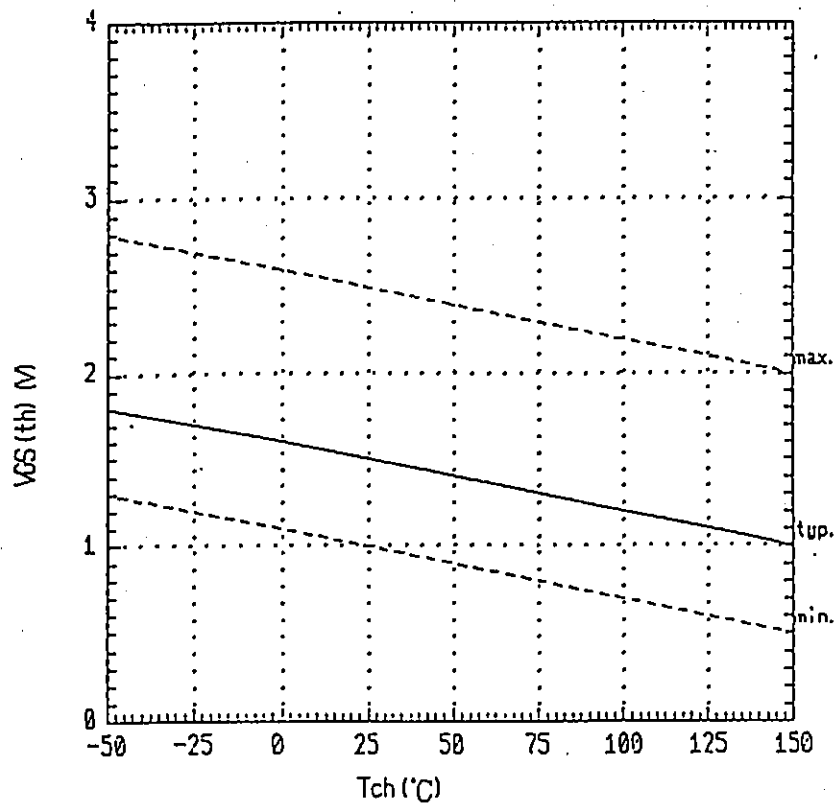

Typical gate charge characteristics
 $V_{GS} = f(Q_g) : I_D = 30A$

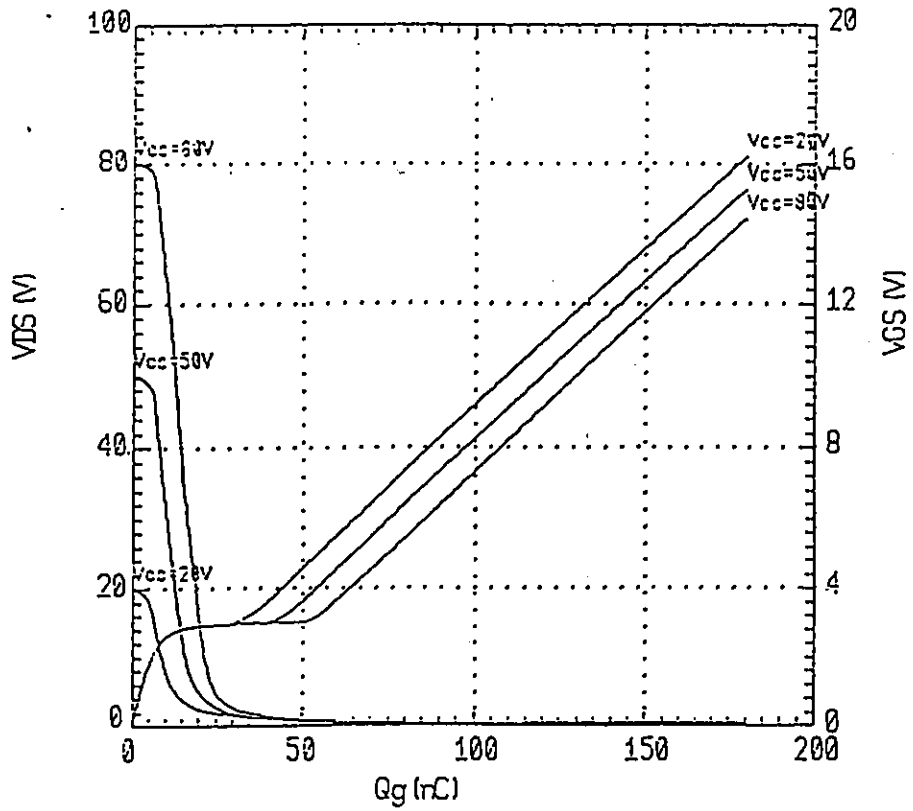

Typical capacitances
 $C = f(V_{DS}) : V_{GS} = 0V, f = 1MHz$

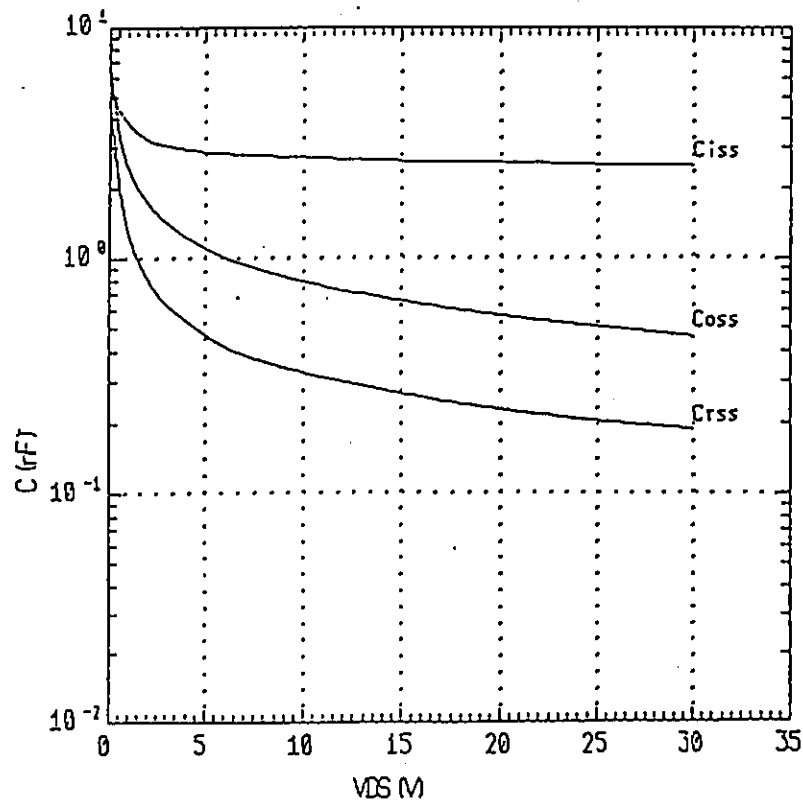

This material and the information herein is the property of Fuji Electric Co., Ltd. They shall be neither reproduced, copied, lent, or disclosed in any way whatsoever for the use of any third party nor used for the manufacturing purposes without the express written consent of Fuji Electric Co., Ltd.

Forward characteristic of reverse diode
 $I_F = f(V_{SD}) : 30 \mu s$ pulse test

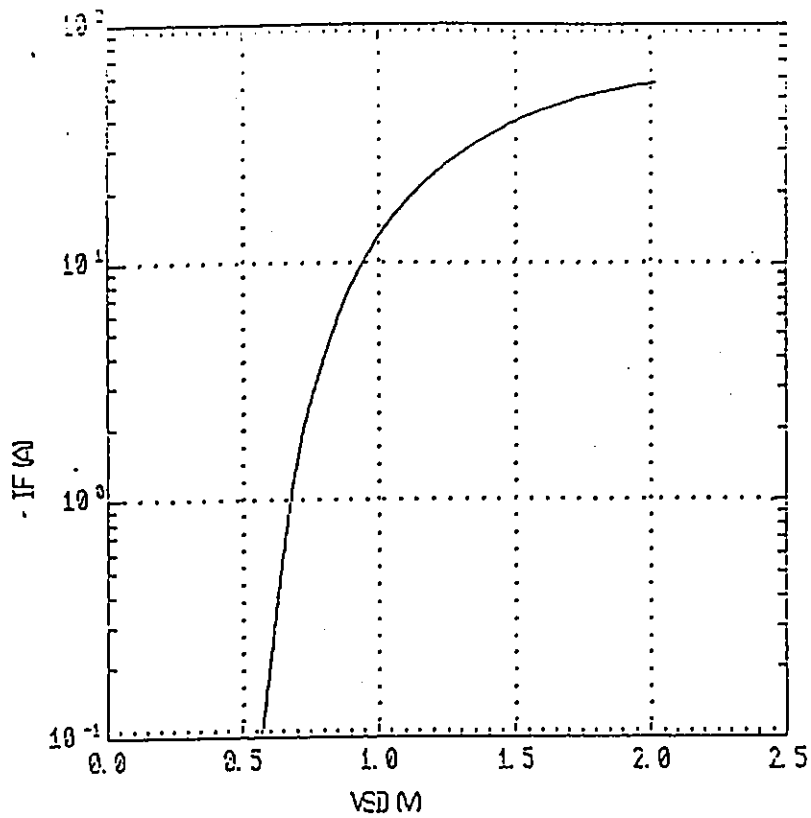

Transient thermal impedande
 $Z_{thch} = f(t)$ parameter: $D = t/T$

