

DIODE Type : 30PDA60

3A 600V Tj =150 °C

OUTLINE DRAWING

FEATURES

- * Low Forward Voltage drop
- * Low Reverse Leakage Current
- * High Surge Capability

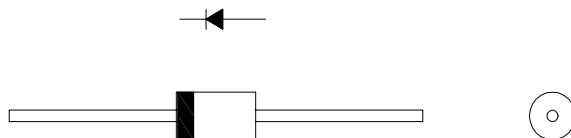

Maximum Ratings

Approx Net Weight:1.24g

Rating	Symbol	30PDA60		Unit	
Repetitive Peak Reverse Voltage	V_{RRM}	600		V	
Average Rectified Output Current	I_O	50Hz Half Sine Wave Resistive Load	Ta=31°C *1	1.6	A
			Tl=124°C (Tl: Lead Temperature)	3.0	
RMS Forward Current	$I_{F(RMS)}$			4.71	A
Surge Forward Current	I_{FSM}	50Hz Half Sine Wave,1cycle, Non-repetitive		100	A
Operating JunctionTemperature Range	T_{jw}	- 40 to + 150			°C
Storage Temperature Range	T_{stg}	- 40 to + 150			°C

Electrical • Thermal Characteristics

Characteristics	Symbol	Conditions	Min.	Typ.	Max.	Unit
Peak Reverse Current	I_{RM}	Tj= 25°C, $V_{RM}= V_{RRM}$	-	-	10	μA
Peak Forward Voltage	V_{FM}	Tj= 25°C, $I_{FM}= 3.0A$	-	-	1.0	V
Thermal Resistance	Rth(j-a)	Junction to Ambient *1	-	-	80	°C/W
	Rth(j-l)	Junction to Lead	-	-	8	

*1: Without Fin or P.C. Board mounted

30PDA OUTLINE DRAWING (Dimensions in mm)

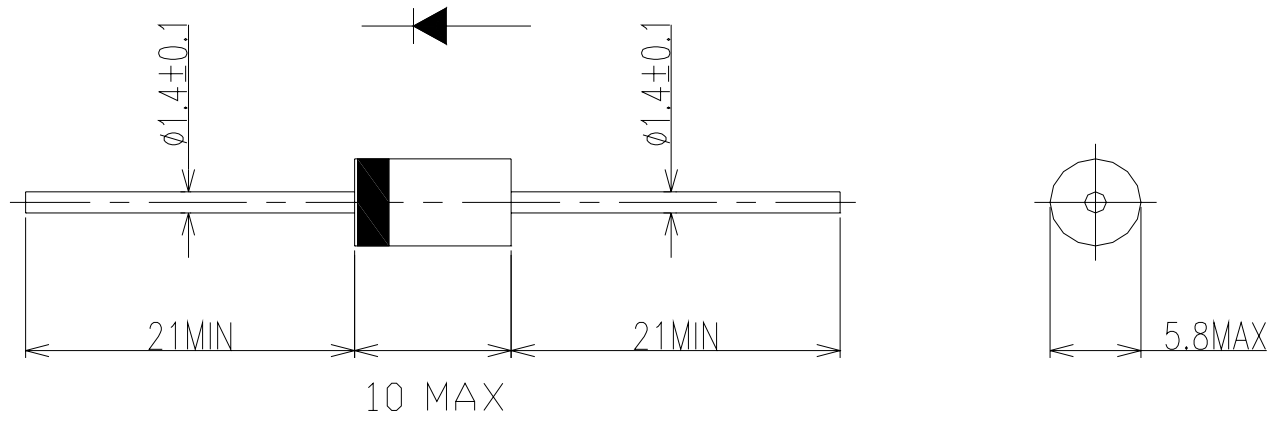

FORWARD CURRENT VS. VOLTAGE

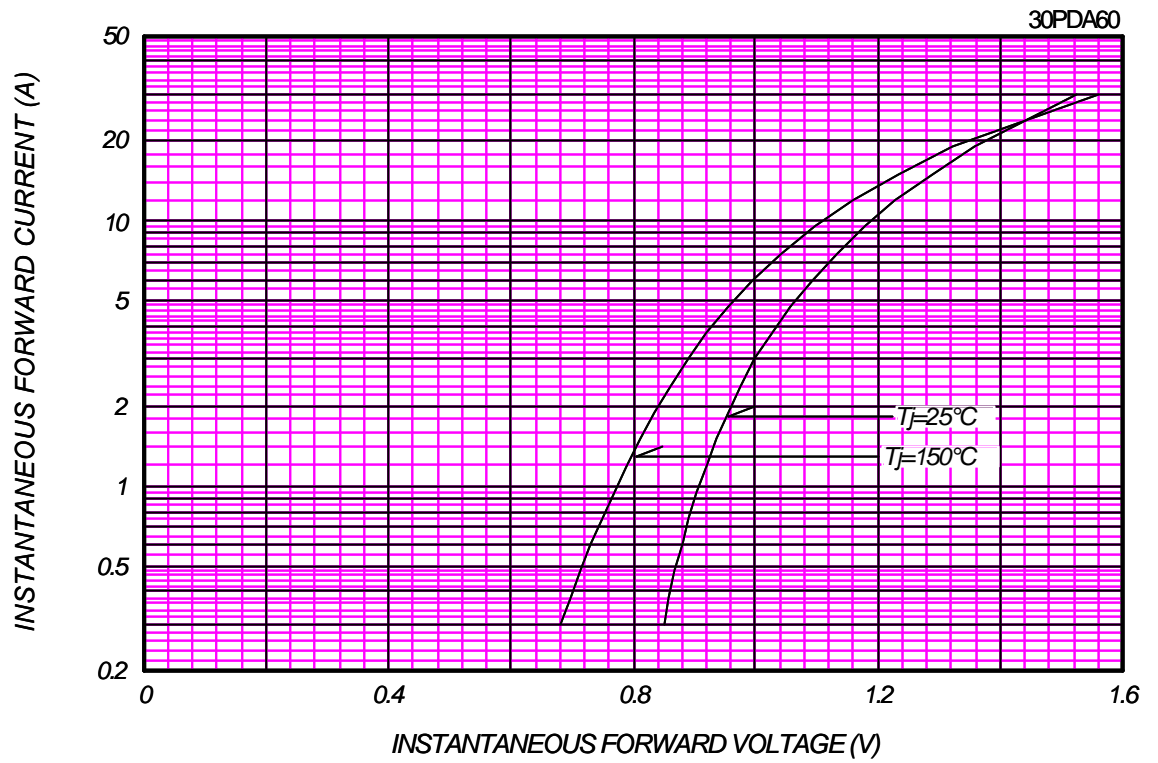

AVERAGE FORWARD POWER DISSIPATION

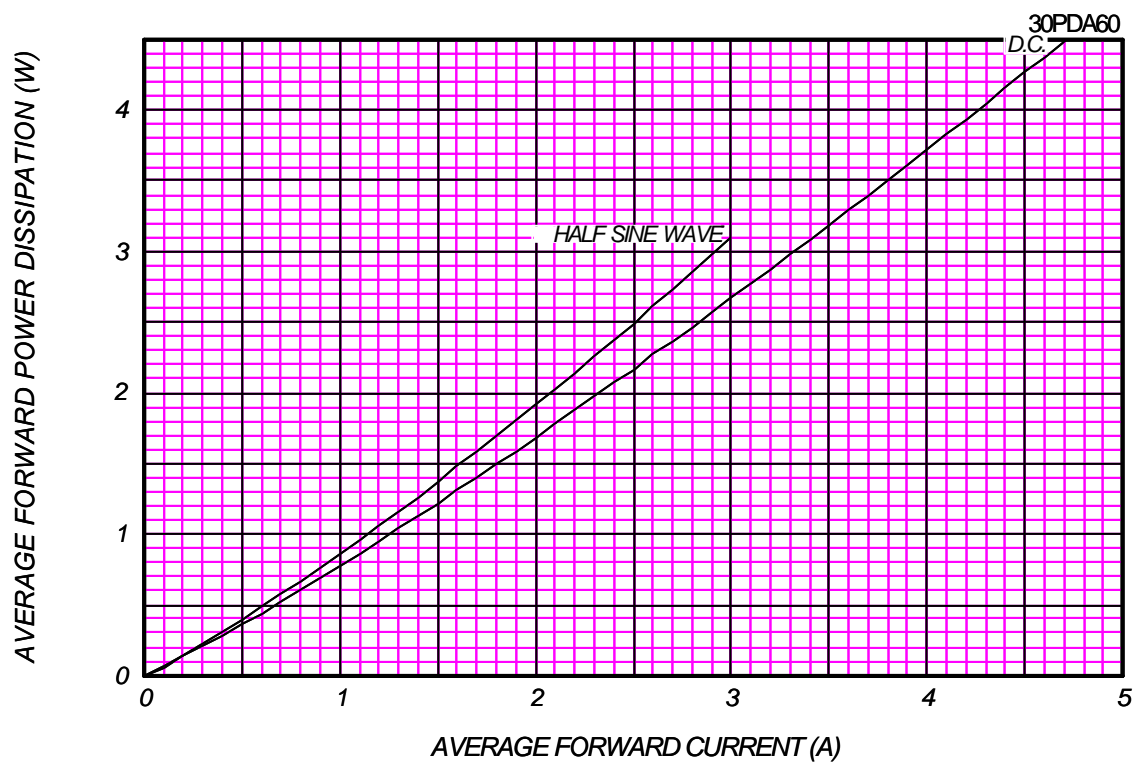

AVERAGE FORWARD CURRENT VS. AMBIENT TEMPERATURE

With Cu Fin (L=3mm,Print Land=5x5mm,Both Sides)

30PDA60

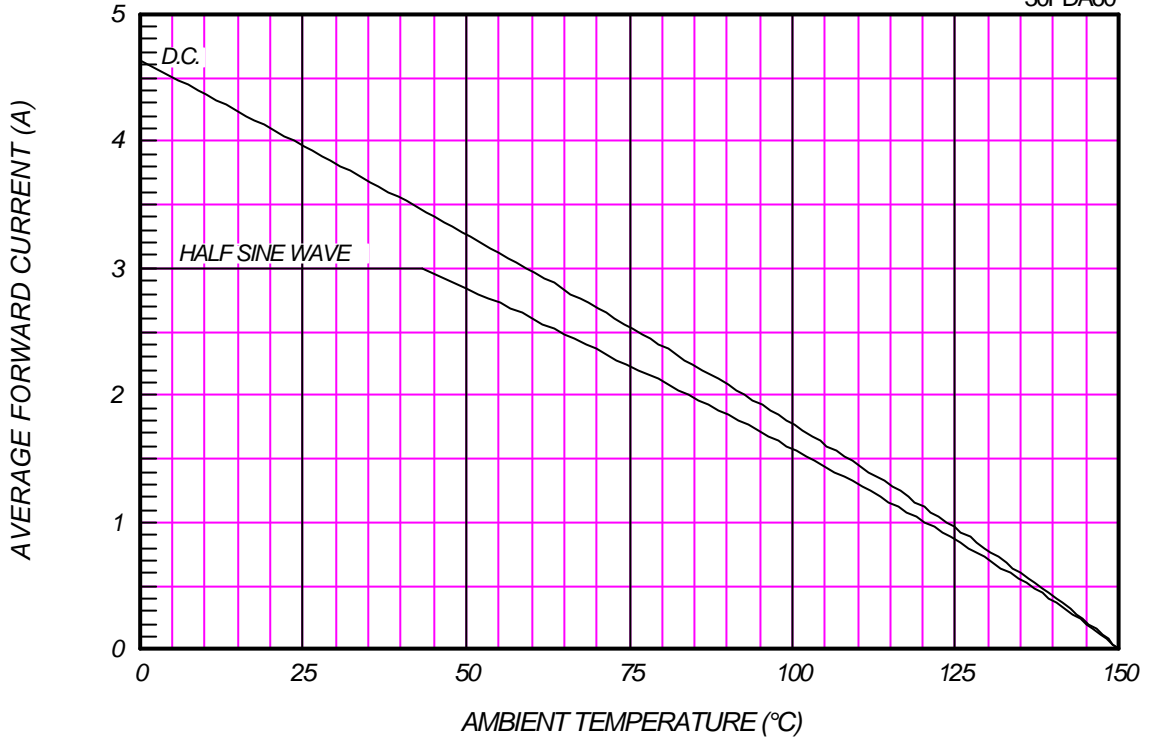

AVERAGE FORWARD CURRENT VS. AMBIENT TEMPERATURE

Without Fin or P.C. Board

30PDA60

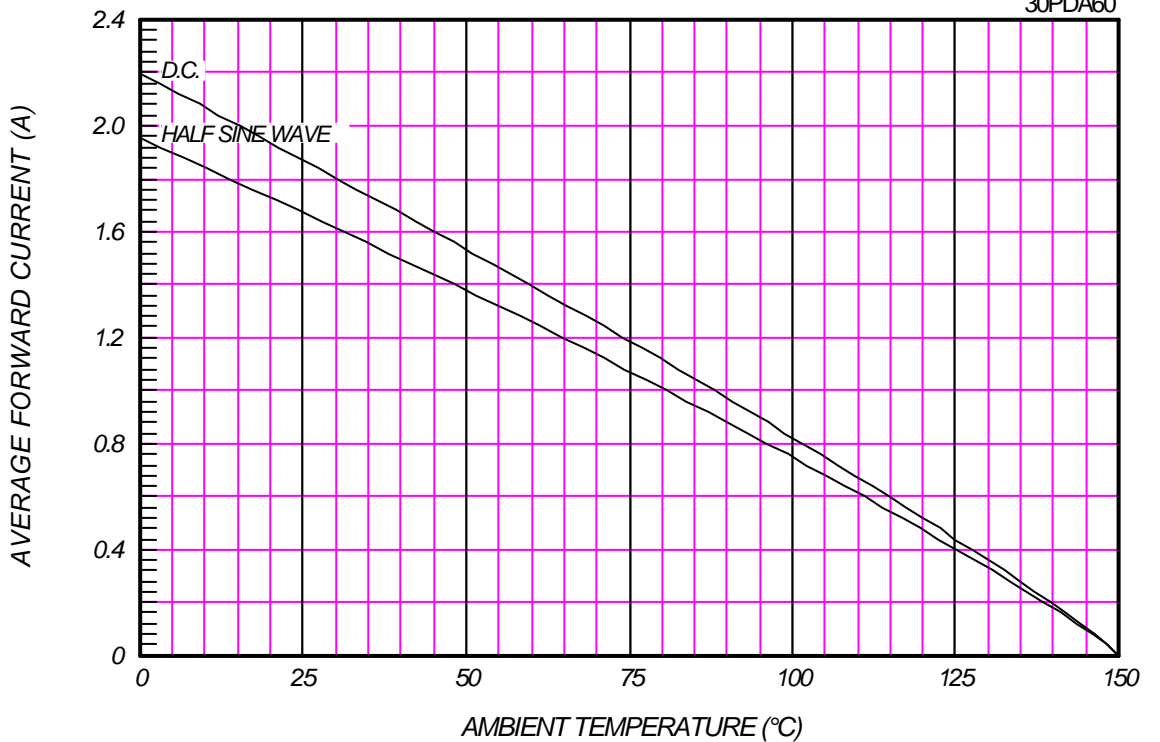

AVERAGE FORWARD CURRENT VS. LEAD TEMPERATURE

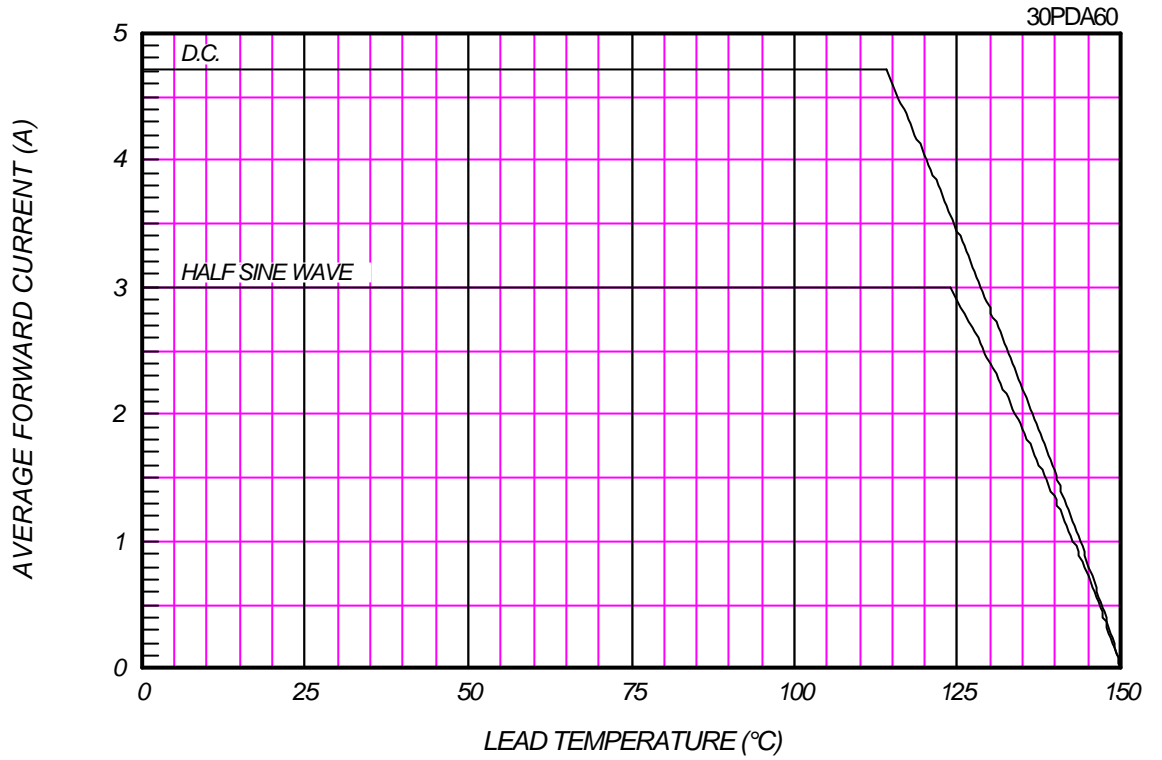

SURGE CURRENT RATINGS

f=50Hz, Half Sine Wave, Non-Repetitive, No Load

