

International
IR Rectifier

30WQ03FNPbF

SCHOTTKY RECTIFIER

3.5 Amp

$$I_{F(AV)} = 3.5\text{Amp}$$

$$V_R = 30\text{V}$$

Major Ratings and Characteristics

Characteristics	Values	Units
$I_{F(AV)}$ Rectangular waveform	3.5	A
V_{RRM}	30	V
I_{FSM} @tp = 5 μ s sine	535	A
V_F @3 Apk, $T_J = 125^\circ\text{C}$	0.35	V
T_J range	-40 to 150	$^\circ\text{C}$

Description/ Features

The 30WQ03FNPbF surface mount Schottky rectifier has been designed for applications requiring low forward drop and small foot prints on PC board. Typical applications are in disk drives, switching power supplies, converters, free-wheeling diodes, battery charging, and reverse battery protection.

- Popular D-PAK outline
- Small foot print, surface mountable
- Low forward voltage drop
- High frequency operation
- Guard ring for enhanced ruggedness and long term reliability
- Lead-Free ("PbF" suffix)

Case Styles



D-PAK (TO-252AA)

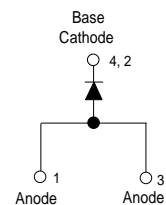

Voltage Ratings

Part number	30WQ03FNPbF
V_R Max. DC Reverse Voltage (V)	30
V_{RWM} Max. Working Peak Reverse Voltage (V)	

Absolute Maximum Ratings

Parameters	30WQ...	Units	Conditions
$I_{F(AV)}$ Max. Average Forward Current * See Fig. 5	3.5	A	50% duty cycle @ $T_C = 134^\circ\text{C}$, rectangular wave form
I_{FSM} Max. Peak One Cycle Non-Repetitive Surge Current * See Fig. 7	535	A	Following any rated load condition and with rated V_{RRM} applied
	90		
E_{AS} Non-Repetitive Avalanche Energy	8	mJ	$T_J = 25^\circ\text{C}$, $I_{AS} = 2$ Amps, $L = 4$ mH
I_{AR} Repetitive Avalanche Current	1.0	A	Current decaying linearly to zero in 1 μsec Frequency limited by T_J max. $V_A = 1.5 \times V_R$ typical

Electrical Specifications

Parameters	30WQ...	Units	Conditions
V_{FM} Max. Forward Voltage Drop * See Fig. 1 (1)	0.45	V	@ 3A
	0.52	V	@ 6A
	0.35	V	@ 3A
	0.46	V	@ 6A
I_{RM} Max. Reverse Leakage Current * See Fig. 2 (1)	2	mA	$T_J = 25^\circ\text{C}$
	50	mA	$T_J = 125^\circ\text{C}$
$V_{F(TO)}$ Threshold Voltage	0.22	V	$T_J = T_J$ max.
r_t Forward Slope Resistance	32.86	m Ω	
C_T Typical Junction Capacitance	290	pF	$V_R = 5V_{DC}$, (test signal range 100Khz to 1Mhz) 25°C
L_S Typical Series Inductance	5.0	nH	Measured lead to lead 5mm from package body
dv/dt Max. Voltage Rate of Change	10000	V/ μs	(Rated V_R)

(1) Pulse Width < 300 μs , Duty Cycle < 2%

Thermal-Mechanical Specifications

Parameters	30WQ...	Units	Conditions
T_J Max. Junction Temperature Range (*)	-40 to 150	$^\circ\text{C}$	
T_{stg} Max. Storage Temperature Range	-40 to 150	$^\circ\text{C}$	
R_{thJC} Max. Thermal Resistance Junction to Case	4.7	$^\circ\text{C/W}$	DC operation * See Fig. 4
wt Approximate Weight	0.3(0.01)	g(oz.)	
Case Style	D-PAK		Similar to TO-252AA
Marking Device	30WQ03FN		

(*) $\frac{dP_{tot}}{dT_J} < \frac{1}{R_{th(j-a)}}$ thermal runaway condition for a diode on its own heatsink

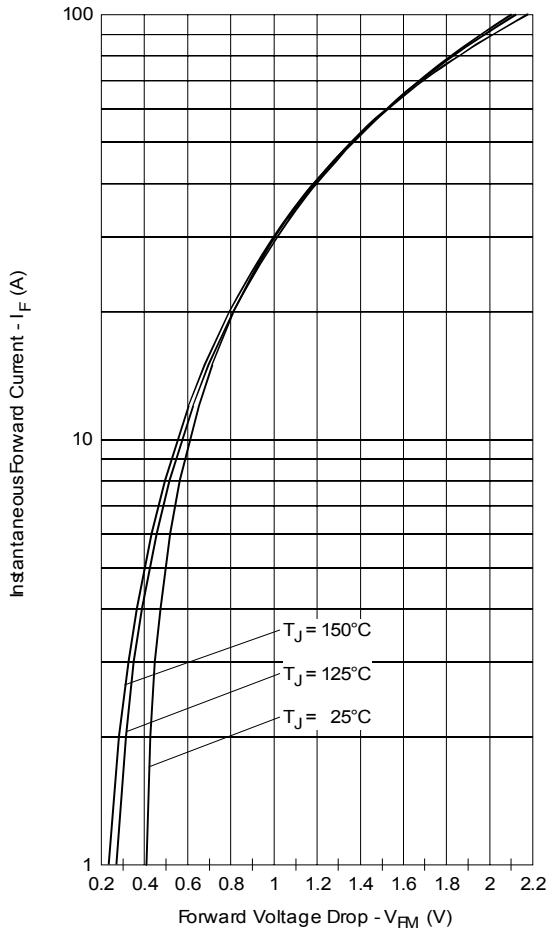

Fig. 1 - Maximum Forward Voltage Drop Characteristics

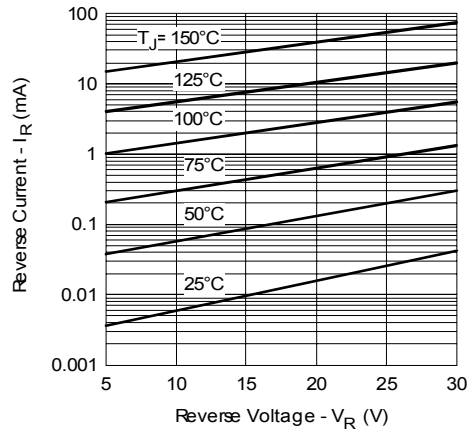

Fig. 2 - Typical Values of Reverse Current Vs. Reverse Voltage

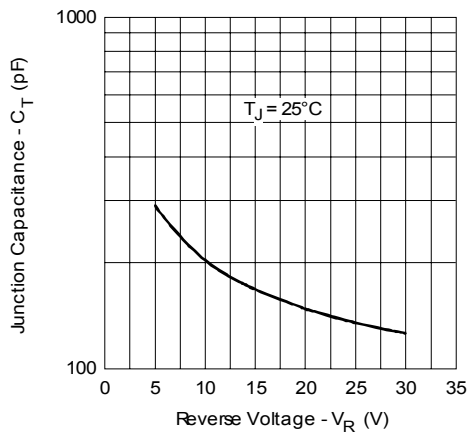

Fig. 3 - Typical Junction Capacitance Vs. Reverse Voltage

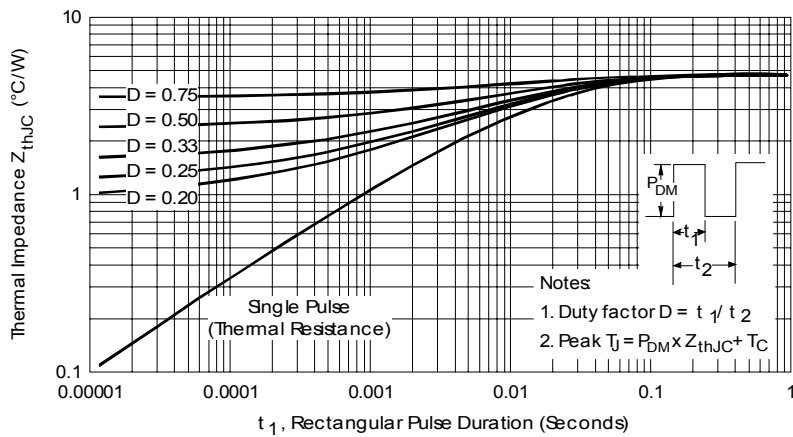

Fig. 4 - Maximum Thermal Impedance Z_{thJC} Characteristics

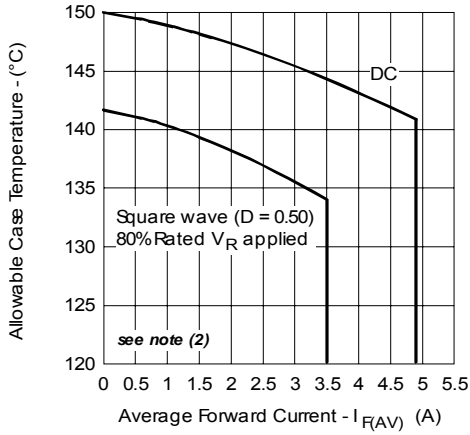

Fig. 5 - Maximum Allowable Case Temperature Vs. Average Forward Current

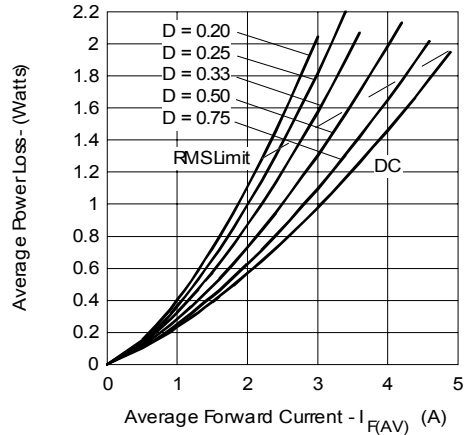

Fig. 6 - Forward Power Loss Characteristics

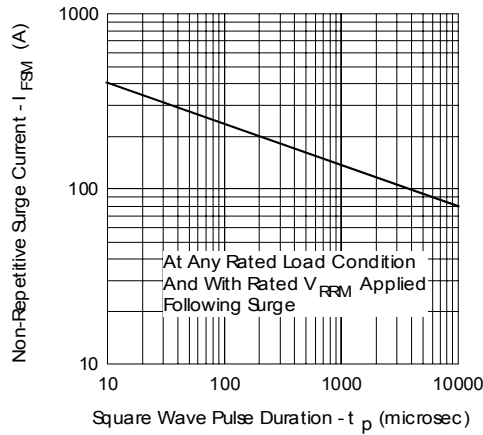

Fig. 7 - Maximum Non-Repetitive Surge Current

(2) Formula used: $T_C = T_J - (P_d + P_{d_{REV}}) \times R_{thJC}$;

P_d = Forward Power Loss = $I_{F(AV)} \times V_{FM} @ (I_{F(AV)}/D)$ (see Fig. 6);

$P_{d_{REV}}$ = Inverse Power Loss = $V_{R1} \times I_R (1-D)$; $I_R @ V_{R1} = 80\%$ rated V_R

Outline Table

NOTES

1. DIMENSIONING AND TOLERANCING PER ASME Y14.5M-1994
2. DIMENSIONS ARE SHOWN IN INCHES (MILLIMETERS)
3. LEAD DIMENSION UNCONTROLLED IN L5
4. DIMENSION OF E1, L3 & B3 ESTABLISH A MINIMUM MOUNTING SURFACE FOR THERMAL PAD
5. SECTION C-C DIMENSIONS APPLY TO THE FLAT SECTION OF THE LEAD BETWEEN .009 AND 0.10 (.23 AND 0.25) FROM THE LEAD TIP
6. DIMENSION D & E DO NOT INCLUDE MOLD FLASH. MOLD FLASH SHALL NOT EXCEED .005 (.13) PER SIDE. THESE DIMENSIONS ARE MEASURED AT THE OUTMOST EXTREMES OF THE PLASTIC BODY.
7. DIMENSION B1 & C1 APPLIED TO BASE METAL ONLY.
8. DATUM A & B TO BE DETERMINED AT DATUM PLANE A.
9. OUTLINE CONFORMS TO JEDEC OUTLINE TO-252AA.

DIMENSIONS	MILLIMETERS		INCHES		NOMINAL VALUE
	MIN.	MAX.	MIN.	MAX.	
A	2.16	2.39	.086	.094	1
A1	-	0.13	-	.009	-
B	0.64	0.69	.025	.028	7
B1	0.65	0.79	.025	.031	7
B2	0.76	1.14	.030	.045	-
B3	4.93	3.46	.193	.215	4
C	0.46	0.61	.018	.024	-
C1	0.41	0.56	.016	.022	7
C2	0.46	0.89	.016	.035	-
D	0.97	6.22	.239	.245	6
D1	5.21	-	.205	-	6
E	6.35	6.73	.250	.265	6
E1	4.32	-	.170	-	6
w	2.29	BSC	.090	BSC	-
H	6.40	10.41	.252	.410	-
L	1.40	1.78	.055	.070	-
L1	2.74	BSC	.108	REF.	-
L2	0.51	BSC	.020	BSC	-
L3	0.89	1.27	.035	.050	4
L4	-	1.02	-	.040	-
L5	1.14	1.52	.045	.060	3
#1	0°	10°	0°	10°	-
#2	0°	15°	0°	15°	-
#3	25°	30°	25°	30°	-

LEAD ASSIGNMENTS

HEXFEET

- 1.- GATE
- 2.- DRAIN
- 3.- SOURCE
- 4.- DRAIN

UB1 & CoPAK

- 1.- GATE
- 2.- COLLECTOR
- 3.- EMITTER
- 4.- COLLECTOR

Modified JEDEC outline TO-252AA
Dimensions in millimeters and (inches)

Part Marking Information

EXAMPLE: THIS IS A 30WQ03FN
LOT CODE 8024
ASSEMBLED ON WW 02, 2000

INTERNATIONAL
RECTIFIER
LOGO

ASSEMBLY
LOT CODE

PART NUMBER

DATE CODE
P = LEAD-FREE
YEAR 0 = 2000
WEEK 02
X = SITE ID

Tape & Reel Information

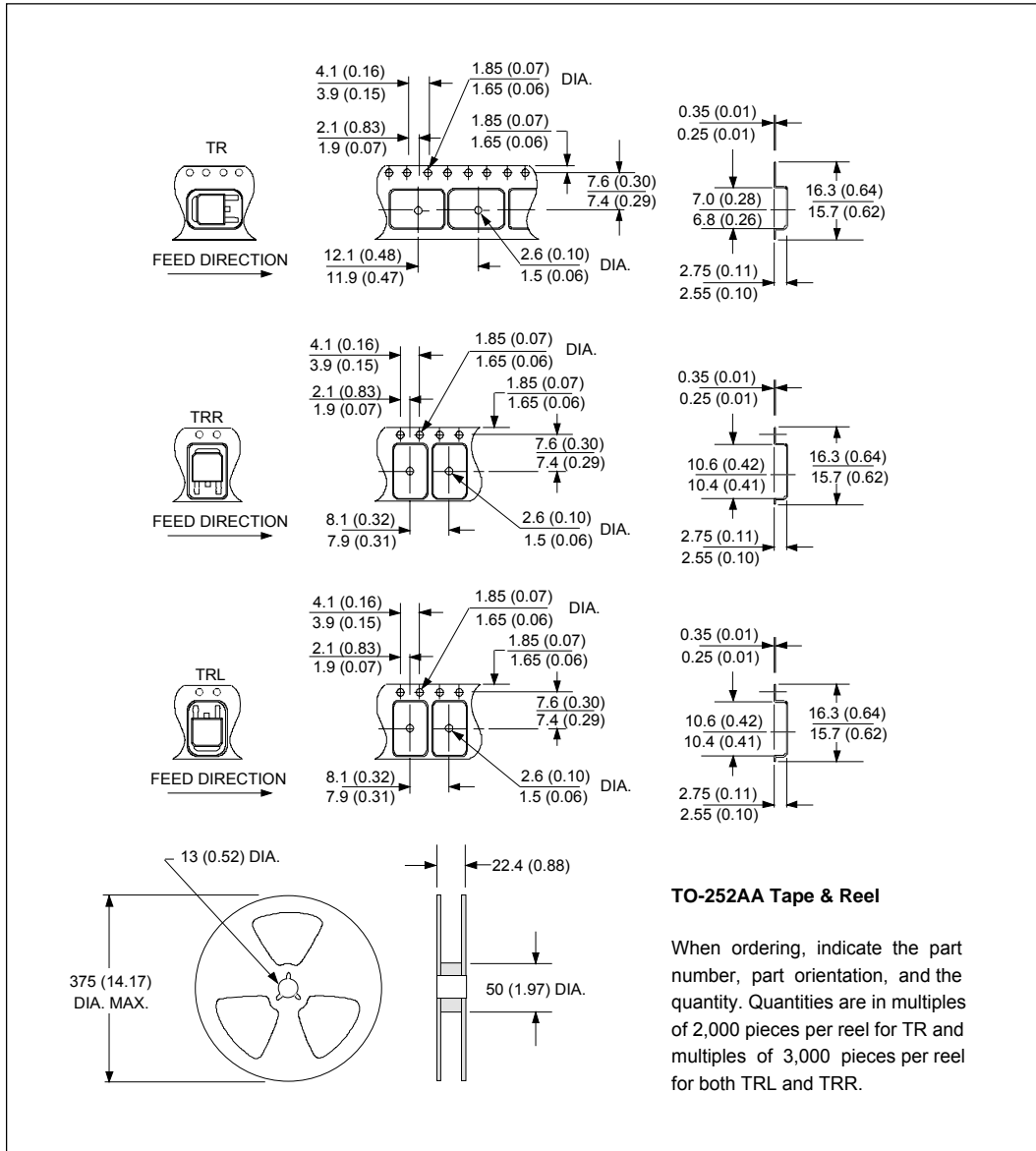

Ordering Information Table

Device Code	
30	W
①	②
Q	03
③	④
FN	TRL
⑤	⑥
PbF	⑦
1	- Current Rating (3.5A)
2	- Package Identifier W = D-Pak
3	- Schottky "Q" Series
4	- Voltage Rating (03 = 30V)
5	- FN = TO-252AA (D-Pak)
6	- <ul style="list-style-type: none"> • none = Tube (50 pieces) • TR = Tape & Reel • TRL = Tape & Reel (Left Oriented) • TRR = Tape & Reel (Right Oriented)
7	- <ul style="list-style-type: none"> • none = Standard Production • PbF = Lead-Free

Data and specifications subject to change without notice.
 This product has been designed and qualified for AEC Q101 Level and Lead-Free.
 Qualification Standards can be found on IR's Web site.