

MODEL 38
10 mm Single-Turn Trimmer
Dust Proof
Carbon Element
Low TCR
RoHS Compliant

New Product

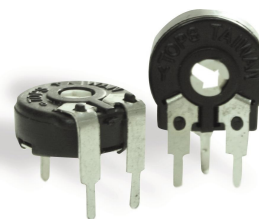

STYLES AVAILABLE

Top Adjust	38P
Side Adjust	38W

ELECTRICAL¹

Resistance Range	100 to 1,000,000 Ohms
Standard Resistance Tolerance	± 30%, (±20% and ±10% available)
Input Voltage, Maximum	200 Vdc
Power rating, Watts	Linear :0.15W, others : 0.07W, at 50 °C
End Resistance, Maximum	2 ohms or 0.5% whichever is greater
Actual Electrical Travel	220° ±20°
Insulation Resistance, Minimum	100 Megohms
Resolution	Essentially infinite
Contact Resistance Variation	5% Max.
Temperature Coefficient of Resistance	±500 ppm/°C

MECHANICAL

Torque, Maximum	1.5 in - oz.
Wiper Position	Approx. 50%

ENVIRONMENTAL

Operating Temperature Range	-25 °C to +70 °C
Rotational Life, 500 Cycles	±3% ΔR
Load Life, 0.15W, 100 Hours, 50°C	±5% ΔR
Resistance to Solder Heat	260°C for 3 sec.
Aqueous cleaning not recommended	

¹ Specifications subject to change without notice.

MODEL 38

ORDERING INFORMATION²

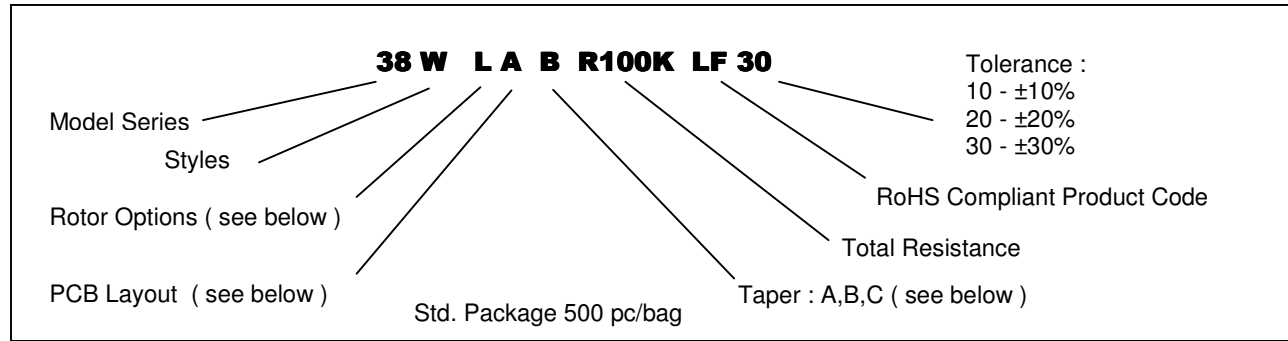

Rotor Options

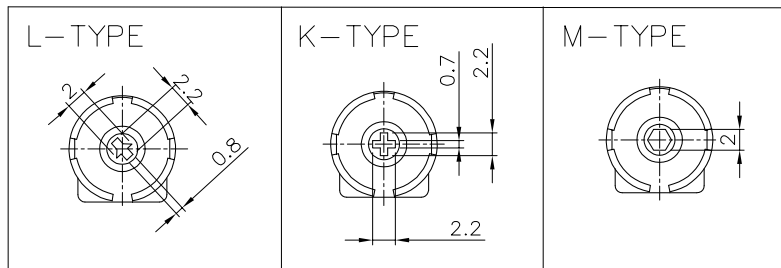

PCB Layout Options

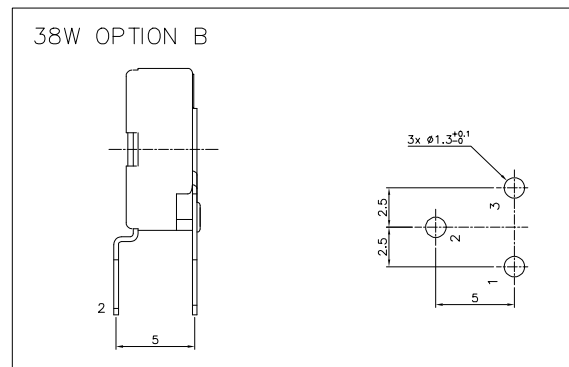
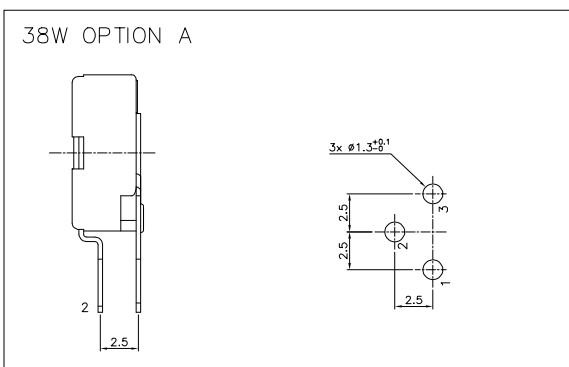
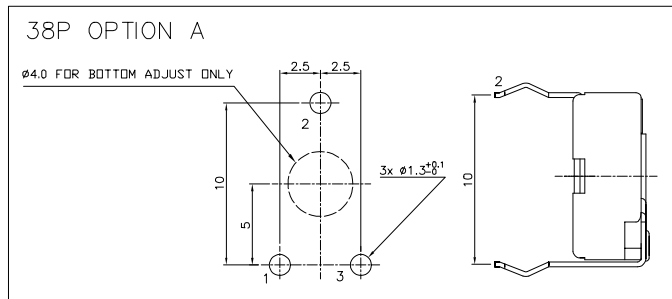

² Contact our customer service for custom designs and features.

MODEL 38

Taper Options

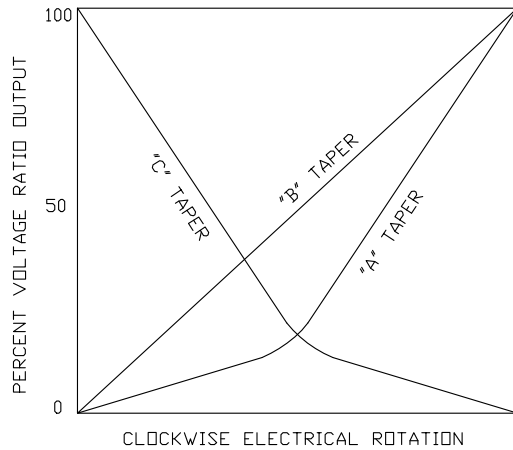

CIRCUIT DIAGRAM

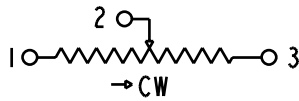

STANDARD RESISTANCE VALUES AND MARKING

100 500 1K 2K 5K 10K 20K 50K 100K 200K 500K 1MEG

OUTLINE DRAWING³

Model 38P (Top Adjust)

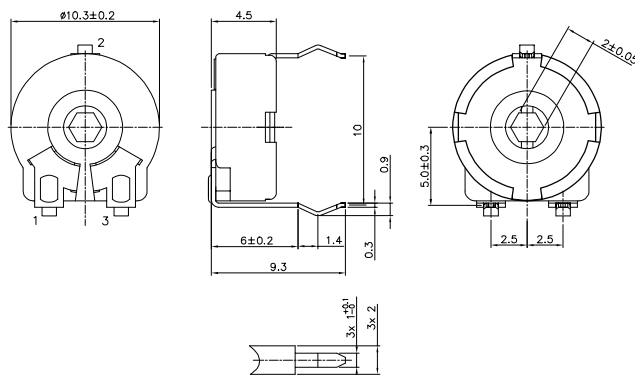

Model 38W (Side Adjust)

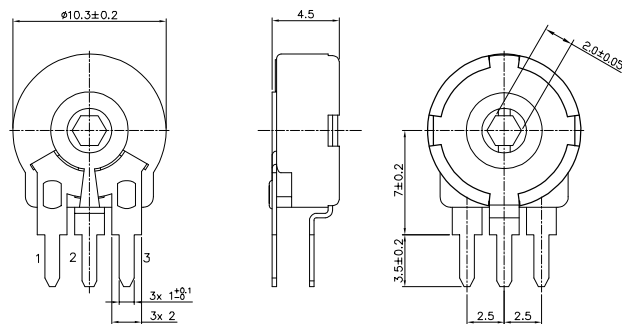

³ Dimensions are in millimeters, Tolerances are ± 0.25 mm unless otherwise stated.