

Multipoint Recorder Arucomp EK-Ex. A

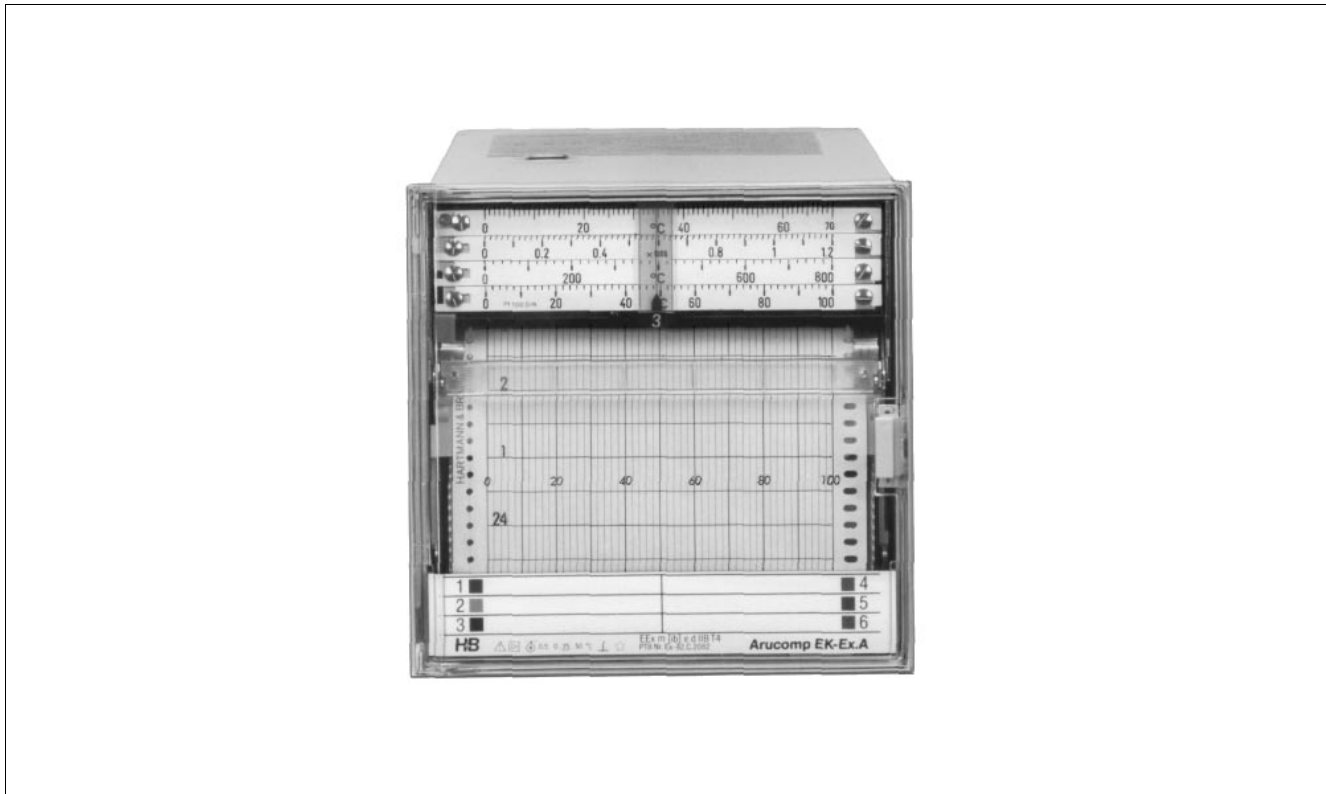

- Multipoint potentiometric recorder for 6 measuring points
- 1 to 6 measuring ranges for standard signals and direct sensor connection
- Last dot visible from front
- Roll or fanfold chart
- Format 144 mm x 144 mm
- Installed depth 305 mm
- Intrinsic safety for signal circuit protection
- Mounting within or outside the hazardous area

Technical data

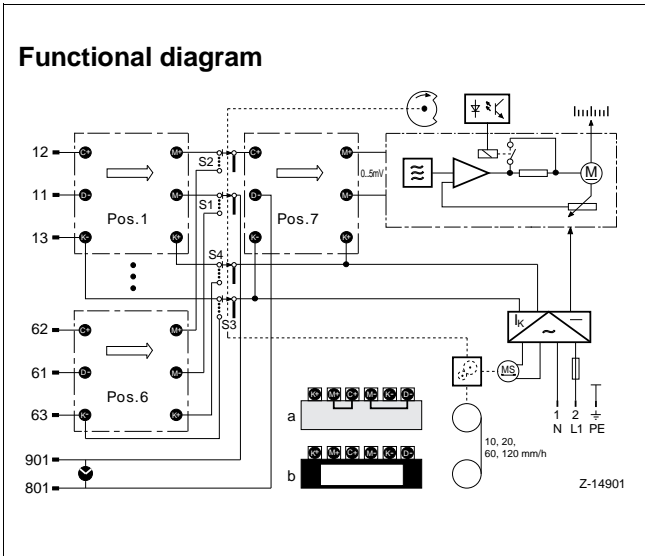

- Resistance measurement
- Resistance thermometer in 2-wire circuit W 24 K
- in 3-wire circuit W 25 K
- Resistance teletransmitter in 3-wire circuit W 26 K
- Current measurement
- without zero shift W 28
- with zero elevation W 27 K
- with zero suppression W 28 K

Continuous overload capacity of signal inputs
± 25 V
electrical motor current switched off at -0.5 % and 100.5 %

Recording section

Scale
interchangeable for all measuring ranges with either 1...6 graduated scales or single scale strips with one graduated scale each

Scale type							
No. of graduated scales	1	2	3	4	5	6	single scale
Digit size (mm)	6	5	3	2.5	2	2	3
Size of main graduations	8	6	4	3	2.5	1.8	3

Colour sequence
Violet, red, black, green, blue, brown (DIN 43 838)
Last point visible from front
ink supply for 5×10^5 dots per colour

Drive
Common synchronous motor for chart drive, measuring point selector switch and print head

Dotting rate
5/10/20 s selectable

Chart drive
10/20/60/120 mm/h selectable

Recording width
100 mm (chart width 120 mm) to DIN 16 230

Chart length
Roll chart 32 m (approx 66 days at 20 mm/h)
Fanfold chart 16 m (approx 33 days at 20 mm/h)

Chart feed-in
Automatic (roll chart)

Power supply

24 V or 115 V or 230 V; 50 Hz or 60 Hz
Tolerated temperature deviation +10 %, -15 %
Typical power consumption approx. 8 VA

General and safety data

Environmental capabilities

Ambient temperature
0...25...50 °C
Transport and storage temperature
-25...+70 °C
Climatic category
KWE to DIN 40 040

Measuring section

Error limit
Accuracy class 0.5 according to DIN 43782/IEC 484 for basic unit 0...5 mV Meßabweichung

Measuring ranges

Via range box type Arucomp 4900/EK-Ex at rear of unit

Incremental error
without zero shift 0.2 % of span
with zero shift 0.3 % of span
zero shift ≥ 1 mA
including temperature effect 0.2 % / 10 K
 $R_e = 20 \text{ k}\Omega/\text{V}$ at least 20 k Ω
Thermometer current $I_{th} \leq 1 \text{ mA}$
Lead balancing for mV in range 0...40 Ω unnecessary
For Ω in 3-wire circuit necessary
For Ω in two-wire circuit of 10 Ω ; 0.1 % external

Reference junction
Optionally external or built into range box.
Caution!
Note temperature difference between terminals and range box

Measuring range limit data
Current measurement $I_e \text{ max. } \pm 50 \text{ mA}; I_e \text{ min. } \pm 0.1 \text{ mA}$
Span min. 0.1 mA; max. 100 mA
 $R_e \leq \frac{7}{I(\text{mA})} [\Omega]$
Voltage measurement -25 V DC...+25 V DC
Span min. 5 mV DC; max. 25 V DC
 $R_e 20 \text{ k}\Omega/\text{V}; \text{ jedoch min. } 20 \text{ k}\Omega$
Zero shift with constant current source
 ± 600 % of selected span (max. 6/7 of upper range value)
Resistance measurement
Scale span min. 8 Ω ; max. 500 Ω

Circuit designation
Direct voltage and thermocouples with external reference junction
without zero shift circuit measuring circuit W 21
with zero elevation W 22 K
with zero suppression W 23 K

Technical data

Relative humidity
 ≤ 75 % annual average; avoid condensation; max. relative humidity ≤ 80 % in operation; pay attention to influence of humidity on chart paper to DIN 16234

Electrical safety tested to DIN VDE 0411 Part 1 / IEC 348

Class of protection I
 Measuring circuits; functional extra-low voltage with safe isolation to VDE 0110 Part 410

Test voltage
 1.5 kV power supply to case
 4 kV measuring circuit to power supply
 0.5 kV measuring circuits to case
 0.5 kV measuring circuits to measuring circuits
 Overvoltage category III }
 Degree of contamination 3 } to DIN VDE 0110 Part 101

Electromagnetic compatibility

The safety requirements stated in the EMC directive 89/336/ EWG, May 1989 shall be fulfilled with respect to immunity to electromagnetic interference to drafted EN 50082.2

Radio interference suppression
 Suppression class N to VDE 0875 or EN 55014

Connection, case and mounting

Electrical connections
 Type of protection IP 20
 Tab connector A 6.3 × 0.8 or A 2.8 × 0.8 or
 MTP 2.4 × 0.8 or as accessory
 Screw terminal for 2 × 1.5 mm² wire

Power supply
 Type of protection IP 54
 Screw terminals for 1.5 mm² wire

Case
 Sheet metal for panel or mosaic panel field mounting
 Colour RAL 7032, Protection IP 54,
 Door made of polycarbonate

Operating orientation
 vertical ± 45 °

Mounting distance
 horizontal or vertical 0 mm,
 case door must be open also at 100 °

Weight
 approx. 5.5 kg

Labelling facilities

On the measuring point designation plate in the door,
 31 characters per measuring point

Parts supplied with the first unit

- 1 Operating manual
- 2 Fastening elements to DIN 43834
- 2 Roll or fanfold charts
- 1 Ink holder (print star)

Explosion protection

Manufacturer's code
 49/40-23 Ex
 Certificate of conformity
 PTB No. Ex-92.C.2082

Type of protection
 EEx m (ib) e d IIB T4

Mounting
 within the hazardous zone 1

Measuring circuits
 (Terminals 11, 12, 13; 21, 22, 23; 31, 32, 33; 41, 42, 43; 51, 52, 53; 61, 62, 63; 801, 901)
 in type of protection intrinsically safe EEx ib IIB or EEx ib IIC

1. Measuring circuits for current, voltage and resistance with range box Arucomp 4900/EK-Ex
 -Ex W21, -Ex W21KV, -Ex W22KV, -Ex W22K, -Ex W23 KV, -Ex W23K, -Ex W24K, -Ex W24K2, -Ex W25K, -Ex W25K2, -Ex W26K, -Ex W27K, -Ex W28, -Ex W28K

Max. values per measuring circuit:

U = 10 V
 I_k = 65 mA
 P = 400 mW

The effective internal inductance is negligibly low.
 The effective internal capacitance is 12 nF.

Max. permitted values of the connected intrinsically safe circuits:

	Group IIC	Group IIB
Max. external inductance La	5 mH	20 mH
Max. external inductance Ca	4 μF	30 μF

- 1.2 Connection to certified **active** intrinsically safe circuits

Max values per circuit

U = 25 V
 P = 600 mW

The maximum internal inductance La and capacitance Ca depending on the respective max. values of the connected intrinsically safe circuit can be taken from tables 1,2 and 3 of the certificate of conformity.

2. Measuring circuits for current with range box Arucomp 4900/EK-Ex
 -Ex W28, -Ex W27K, -Ex W28K with input resistance R_e ≤ 7 Ω

Max. values per circuit

U = 0.5 V
 I_k = 65 mA
 P = 8 mW

The effective internal inductance is negligibly low.
 The effective internal capacitance is 12 nF.

Max. permitted values of the connected intrinsically safe circuits:

Max values per circuit
 U = 20 V
 I = 170 mA

The maximum internal inductance La and capacitance Ca depending on the respective max. values of the connected intrinsically safe circuit can be taken from tables 4 and 5 of the certificate of conformity.

The six measuring circuits are electrically isolated. The respective measuring circuit in operation and the circuit for the external reference junction are electrically coupled.

Note:

The values mentioned above do not apply to a plug connection. Those values can be taken from the annex to the certificate of conformity.

Multipoint Recorder Arucomp EK-Ex. A

Data Sheet
40-1.10 EN

Ordering information

Multipoint recorder Arucomp EK-Ex. A Catalogue No. **4 1 0 1 1 - 0 -**

Basic unit ¹⁾	05	0 0 1
Application circuit SW (one measuring range)	06	
Application circuit MW (one to six measuring ranges)	07	

Power supply

24 V 50 Hz	1	0 0 1
115 V 50 Hz	2	
230 V 50 Hz	3	
24 V 60 Hz	6	
115 V 60 Hz	7	
230 V 60 Hz	8	

Recording

On roll chart	1	0 0 1
On fanfold chart	3	

Catalogue No. **4 1 0 1 1 - 0 -** **0 0 1**

For ordering the Catalogue No. suffices.
 If necessary suffix supplementary Nos. to the catalogue numbers.

¹⁾ Measuring basis 0...5 mV, without range box and scales

Consumables

	Catalogue No.
Ink holder	41081-4-0859569
Chart paper	
Roll chart (supplied in packs of 10)	
with hourly time imprint for 20 mm/h	40920-0-3000505
without hour imprint, with baselines	40920-0-3000150
Fanfold chart (supplied in packs of 20)	
with hourly time imprint for 20 mm/h	40926-0-3000502
without hour imprint, with baselines	40926-0-3000003

Other charts paper see Data Sheet 49-9.10 EN.





Additional ordering information

At least one specification is necess. for every measuring range and group **Suppl. No.**

Specification for measuring range 1		1
Specification for measuring range 2		2
Specification for measuring range 3		3
Specification for measuring range 4		4
Specification for measuring range 5		5
Specification for measuring range 6		6

The following specification applies to measuring point(s) e.g. 2 and 5)  ¹⁾

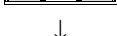

Measuring circuit designation depending on the measuring tasks
 Measuring circuit W2. or W2.K **5**
 Measuring circuit W2.KV (built-in reference junction correction) **6**  ¹⁾

Measuring range
 Code according to Data Sheet 40-1.00 EN **1** (...)  ¹⁾
 As specified **2**  ¹⁾
 Code for external reference junction temperature  ¹⁾
 With test resistor in dismantled form for °C Pt 100 IEC  ¹⁾

Scale specifications

Scale on wide scale plate **506**
 (for large digits with 1 or 2 graduations or max. 6 graduations)

1st graduation		1
2nd graduation		2
3rd graduation		3
4th graduation		4
5th graduation (only applies in connection with Suppl. No. 506)		5
6th graduation (only applies in connection with Suppl. No. 506)		6

Without graduation, scale start and end marked (for 1st graduation only) **1**  ¹⁾
 Graduation 0...100 (for 1st graduation only) **2**
 Graduation as specified (enter only clear text) **5**
 Graduation according to Data Sheet 40-1.00 EN (enter code No.) **3** (...)  ¹⁾

With ruler for ... graduation  ¹⁾

Labelling of the measuring point designation plate

Inscription for measuring point 1	580	<input type="text"/>
Inscription for measuring point 2	582	<input type="text"/>
Inscription for measuring point 3	584	<input type="text"/>
Inscription for measuring point 4	586	<input type="text"/>
Inscription for measuring point 5	588	<input type="text"/>
Inscription for measuring point 6	590	<input type="text"/>

With dismantled dust-proof bracket for top of door **621**
 with ... packs of 10 blade sleeves **603**
 with ... packs of 10 clip-on screw terminals **604** (... pcs.)
 with four dismantled mounting brackets for rack mounting **605**

Operating Manual (state how many)²⁾
 German (no specification required for 1 copy) **Z2D** (... cps.)
 English (always state Suppl. No.) **Z2E** (... cps.)
 French (always state Suppl. No.) **Z2F** (... cps.)

At this symbol add clear text to the Suppl. No.
 (...) At this symbol add a code No. to this Suppl. No.

¹⁾ At least one Suppl. No. per scale and group
²⁾ 1 copy at no extra charge

Dimensional drawings and connection diagrams

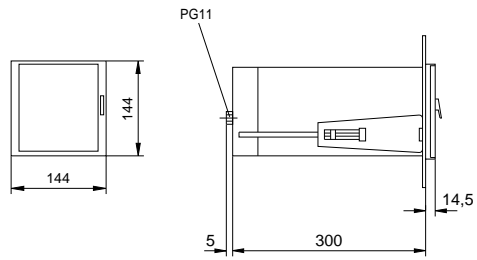

Panel cutout

Z-16339 EN

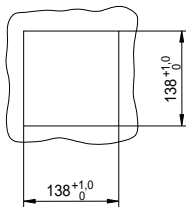

(dimensions in mm)

Connection diagram

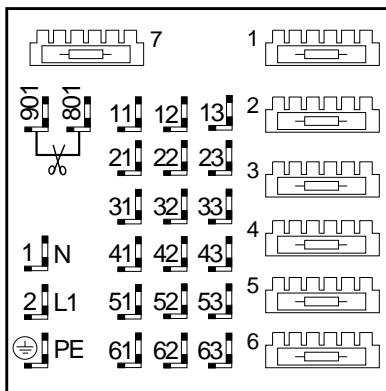
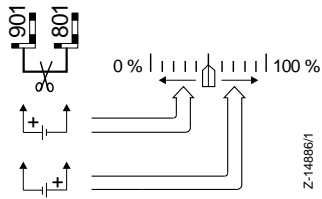

Z-14886/2

Channel 1	11 12	11 12	11 12	11 12 13	11 12 13
Channel 2	21 22	21 22	21 22	21 22 23	21 22 23
Channel 3	31 32	31 32	31 32	31 32 33	31 32 33
Channel 4	41 42	41 42	41 42	41 42 43	41 42 43
Channel 5	51 52	51 52	51 52	51 52 53	51 52 53
Channel 6	61 62	61 62	61 62	61 62 63	61 62 63

Z-14886/3 EN

