

T-41-21

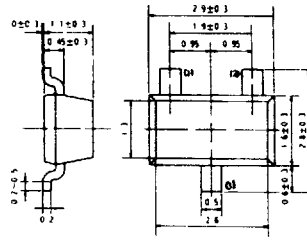
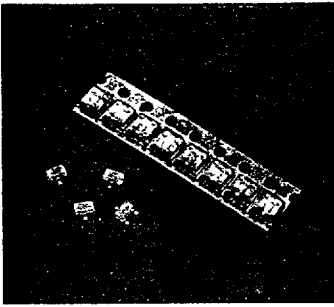

SOT23 Package shape

Each lead has the same dimensions

Colour and lens type	Luminous intensity @ 20mA typical (mcd)	Forward voltage @ 10mA typical (VF)	Peak wavelength (nm)	Max power dissipation (mW)	Max continuous forward current (mA)
	1.0	2.0	650	75	25
Amber	1.0	2.0	610	75	25
Yellow	1.0	2.0	585	75	25
	2.5	2.0	563	75	25
Red/Amber	1.0/1.0	2.0	650/610	75	25
Amber/Yellow	1.0/1.0	2.0	610/585	75	25
Red/Green	1.0/2.5	2.0	650/563	75	25

Quantity	1+	500+	1000+
5711R	18.40	15.82	13.98
5712A	19.70	16.94	14.97
5713Y	19.70	16.94	14.97
5714G	19.70	16.94	14.97
5721RA	36.70	31.56	27.89
5722YA	36.70	31.56	27.89
5723RG	36.70	31.56	27.89

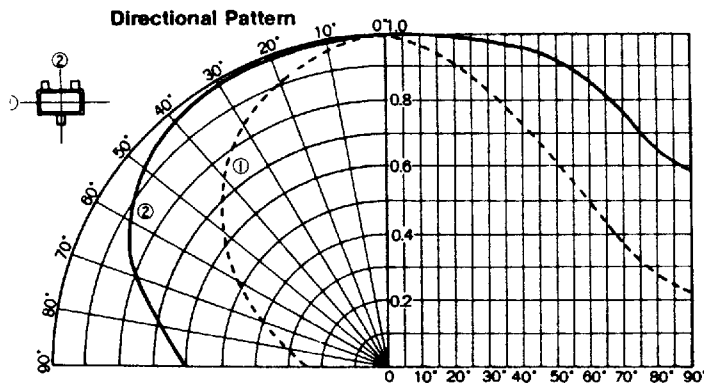

**Packaging**

Standard package is milky white but for ease of identification the single colour red and green types are available with a red or green tinted diffuser. Supplied in standard 'Super 8' tape for automatic insertion equipment.

**Soldering**

Recommended soldering conditions are, Preheat 140 - 160°C for 1 minute max. Solder 210 - 230°C for 5 seconds max.

**Operating temperatures**

T<sub>opr</sub> -25 to +75 °C  
T<sub>stg</sub> -30 to +85 °C

**Pinout**

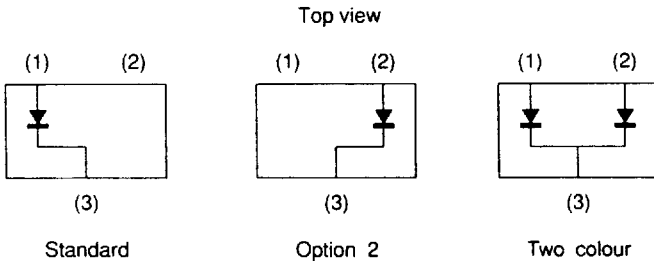

In dual colour devices the first letter of the part number indicates the LED connected to pin 1

## Lighthouse Style Circular LEDs - 2mm

5400 Series

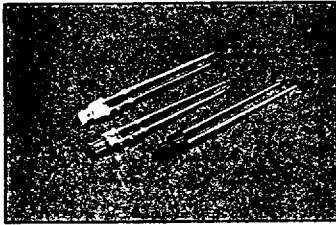

Frequently specified for through-panel applications where a bright spot of light with a wide viewing angle is required  
Milky white encapsulant types are available for secret colour and high on/off contrast ratio

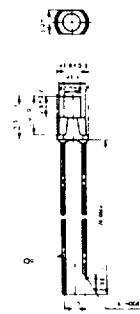

T-41-21

Head is a 2mm dia cylinder, viewing angle is achieved with the flat matte emitting surface.  
Available with or without leg pips for PCB standoff - suffix /A for no pips.

Colour and lens type	Luminous intensity @ 20mA typical (mcd)	Forward voltage @ 10mA typical (VF)	Peak wavelength (nm)	Viewing angle half intensity (degrees)	Max power dissipation (mW)	Max continuous forward current (mA)
	3.2	2.0	650	100	60	20
	3.2	2.0	650	100	60	20
	3.2	2.1	563	100	75	25
	3.2	2.1	563	100	75	25
Yellow-D	1.0	2.1	585	100	60	20
Amber-D	2.0	2.0	635	100	60	20

Quantity	1+	500+	1000+
5401RD	14.90	12.81	11.32
5402RW	14.90	12.81	11.32
5403GD	15.50	13.33	11.78
5404GW	15.50	13.33	11.78
5405YD	16.00	13.76	12.16
5406AD	16.00	13.76	12.16

## Lighthouse Style Circular LEDs - 2.5mm

5400 Series

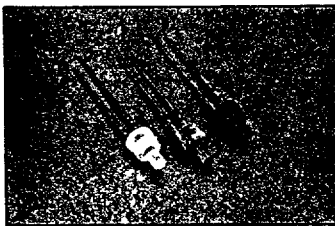

Frequently specified for through panel applications where a bright spot of light with a wide viewing angle is required  
Milky white encapsulant types are available for secret colour and high on/off contrast ratio.

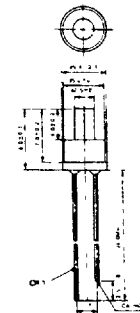

Head is a 2.5mm dia cylinder, wide viewing angle is achieved with the flat matte emitting surface.  
Available with or without leg pips for PCB standoff - suffix /A for no pips

Colour and lens type	Luminous intensity @ 20mA typical (mcd)	Forward voltage @ 10mA typical (VF)	Peak wavelength (nm)	Viewing angle half intensity (degrees)	Max power dissipation (mW)	Max continuous forward current (mA)
	2.0	2.0	650	100	60	20
	2.0	2.0	650	100	60	20
	3.2	2.1	563	100	75	25
	3.2	2.1	563	100	75	25
Yellow-D	2.0	2.1	585	100	60	20
Amber-D	2.0	2.0	635	100	60	20

Quantity	1+	500+	1000+
5407RD/A	14.90	12.81	11.32
5408RW	14.90	12.81	11.32
5409GD/A	15.50	13.33	11.78
5410GW	15.50	13.33	11.78
5411YD/A	16.00	13.76	12.16
5412AD	16.00	13.76	12.16

## Lighthouse Style Square LEDs - 2 x 2mm

5400 Series

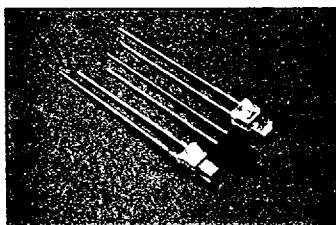

Applications include mimic and multicolour indication.

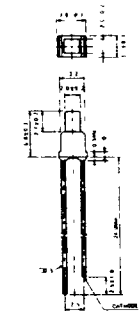

Head is 2mm square and 2.7mm high.

Colour and lens type	Luminous intensity @ 20mA typical (mcd)	Forward voltage @ 10mA typical (VF)	Peak wavelength (nm)	Viewing angle half intensity (degrees)	Max power dissipation (mW)	Max continuous forward current (mA)
	1.0	2.0	650	100	50	20
	1.6	2.1	563	100	75	25
Yellow-D	1.6	2.1	585	100	60	20

Quantity	1+	500+	1000+
5413RD	14.90	12.81	11.32
5414GD	15.50	13.33	11.78
5415YD	16.00	13.76	12.16

Free Samples Available

**IMO**  
ELECTRONICS

All Prices are £/100 Pieces

## Axial Type - Resistor Style LEDs

5500 Series

T-41-21

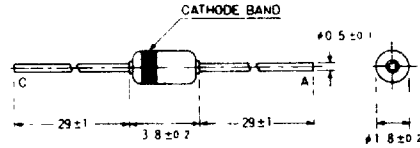
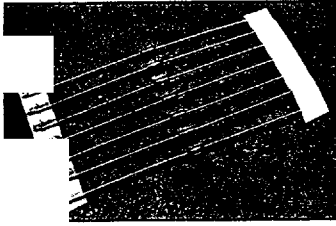

Cathode band colour is  
 Blue for Red emitting LED  
 Green for Green emitting LED  
 Red for Amber emitting LED

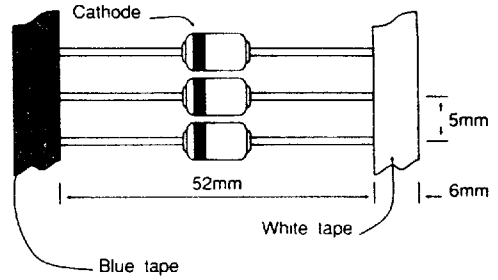

Glass sealed package to Jedec DO-35  
 Light is emitted at right angles to the package in a full 360° circumference  
 Frequently used for PCB diagnostic indication  
 May be used as a low voltage regulator  
 Available taped as shown, or loose - Reel quantity 5000 pcs

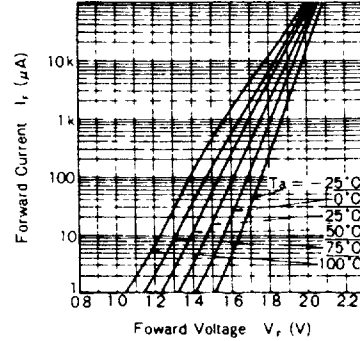

Colour and lens type	Luminous intensity @ 20mA typical (mcd)	Forward voltage @ 10mA typical (VF)	Peak wave-length (nm)	Viewing angle half intensity (degrees)	Max power dissipation (mW)	Max continuous forward current (mA)
	1.2	1.7	700	360	25	10
	1.2	1.7	563	360	25	10
Amber	1.2	1.7	635	360	25	10

Quantity	1+	500+	1000+
5501RD	11.10	9.55	8.44
5502GD	11.55	9.93	8.78
5503AD	11.95	10.28	9.08

## Axial Type - Subminiature Lensed LEDs

5600 Series

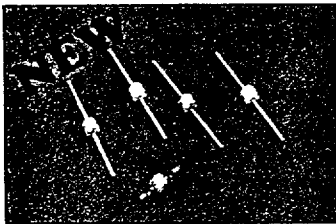

Applications include indication in consumer appliances, audio equipment and switch tops  
 Available loose as standard or taped  
 Preformed leads (for surface mounting etc.) are available for OEM quantities - please contact the sales desk for details

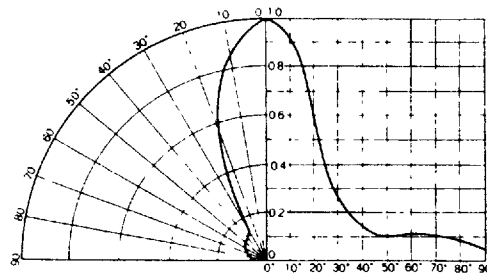
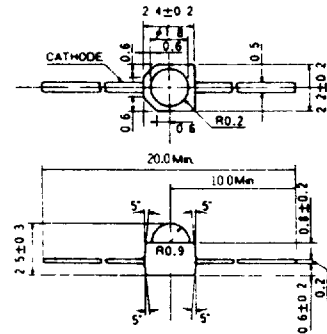

Colour and lens type	Luminous intensity @ 10mA typical (mcd)	Forward voltage @ 10mA typical (VF)	Peak wave-length (nm)	Viewing angle half intensity (degrees)	Max power dissipation (mW)	Max continuous forward current (mA)
	4.0	2.8	650	-	75	25
	4.0	2.8	650	-	75	25
	6.3	2.8	563	-	75	25
	6.3	2.8	563	-	75	25
Yellow-T	4.0	2.8	585	-	75	25
Yellow-C	4.0	2.8	585	-	75	25

Quantity	1+	500+	1000+
5601RT	22.75	18.20	16.52
5602RC	22.75	18.20	16.52
5603GT	24.22	19.37	17.59
5604GC	24.22	19.37	17.59
5605YT	22.75	18.20	16.52
5606YC	22.75	18.20	16.52

Technical Support - 01 452 6444

**IMO**  
ELECTRONICS

All Prices are £/100 Pieces

## Rectangular Style - Stacking LEDs 4.9 x 1.9mm

AVAILABLE

5200 Series

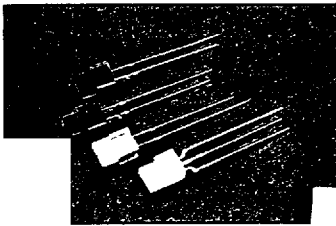

Unique design permits stacking for mimic applications etc.  
Wide viewing angle is achieved by the flat matte emitting surface  
Bi-colour is a three lead device

IMO ELECTRONICS LTD



Rectangular LEDs stacked in 'X' and 'Y' directions.

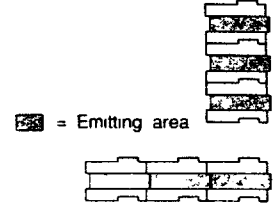
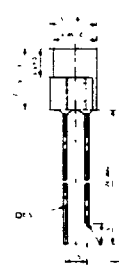

■ = Emitting area

Colour and lens type	Luminous intensity @ 20mA typical (mcd)	Forward voltage @ 10mA typical (VF)	Peak wavelength (nm)	Viewing angle half intensity (degrees)	Max power dissipation (mW)	Max continuous forward current (mA)
	2.0	2.0	650	100	60	20
	2.0	2.1	563	100	75	25
Yellow-D	2.0	2.1	585	100	60	20
Red/ Green-W	2.0	2.0	635	100	60	20
	2.0	2.1	563	100	75	25

Quantity	1+	500+	1000+
5201RD	13.96	12.01	10.61
5202GD	14.50	12.47	11.02
5203YD	15.00	12.90	11.40
5204RGW	40.00	34.40	30.40

## Rectangular Style LEDs 7.5 x 2.5mm

5200 Series

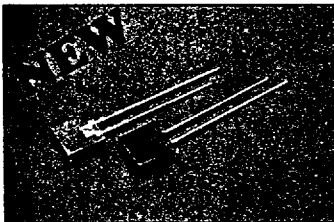

Rectangular type with no flange to allow 'X' or 'Y' stacking with no gaps.  
Applications include matrix displays, bargraphs etc.

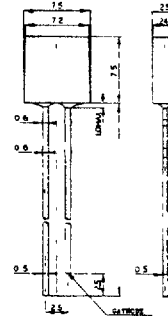

Colour and lens type	Luminous intensity @ 10mA typical (mcd)	Forward voltage @ 10mA typical (VF)	Peak wavelength (nm)	Viewing angle half intensity (degrees)	Max power dissipation (mW)	Max continuous forward current (mA)
	1.0	2.0	650	100	60	20
	1.6	2.1	563	100	75	25
Yellow-D	1.0	2.1	585	100	60	20

Quantity	1+	500+	1000+
5211RD	14.90	12.81	11.32
5212GD	15.50	13.33	11.78
5213YD	16.00	13.76	12.16

## Rectangular Style LEDs 2 x 3.8mm

5200 Series

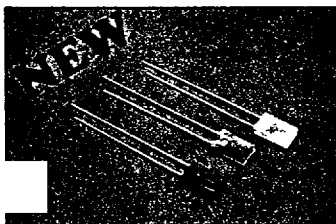

Compact rectangular type with no flanges to allow 'X' or 'Y' stacking with no gaps.  
Applications include matrix displays, bargraphs etc.

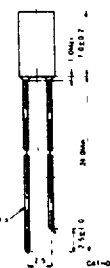

Colour and lens type	Luminous intensity @ 10mA typical (mcd)	Forward voltage @ 10mA typical (VF)	Peak wavelength (nm)	Viewing angle half intensity (degrees)	Max power dissipation (mW)	Max continuous forward current (mA)
	1.0	2.0	650	100	60	20
	1.6	2.1	563	100	75	25
Yellow-D	1.0	2.1	585	100	60	20

Quantity	1+	500+	1000+
5221RD	14.90	12.81	11.32
5222GD	15.50	13.33	11.78
5223YD	16.00	13.76	12.16

Free Samples Available

**IMO**  
ELECTRONICS

All Prices are £/100 Pieces

