

V_{RRM}	=	400 V
I_{FAVM}	=	13526 A
I_{FRMS}	=	21247 A
I_{FSM}	=	85000 A
V_{F0}	=	0.758 V
r_F	=	0.021 mW

Housingless Welding Diode

5SDD 0135Z0400

PRELIMINARY

Doc. No. 5SYA1179-00 March 07

- High forward current capability
- Low forward and reverse recovery losses
- High current application up to 2000 Hz
- For parallel connection, please contact factory

Blocking

V_{RRM}	Repetitive peak reverse voltage	400 V	Half sine waveform, $f = 50$ Hz $T_j = -40...180$ °C
I_{RRM}	Repetitive peak reverse current	75 mA	$V_R = V_{RRM}$

Mechanical

F_M	Mounting force	35..70 kN
m	Weight	0.14 kg
D_S	Surface creepage distance	2 mm
D_a	Air strike distance	2 mm

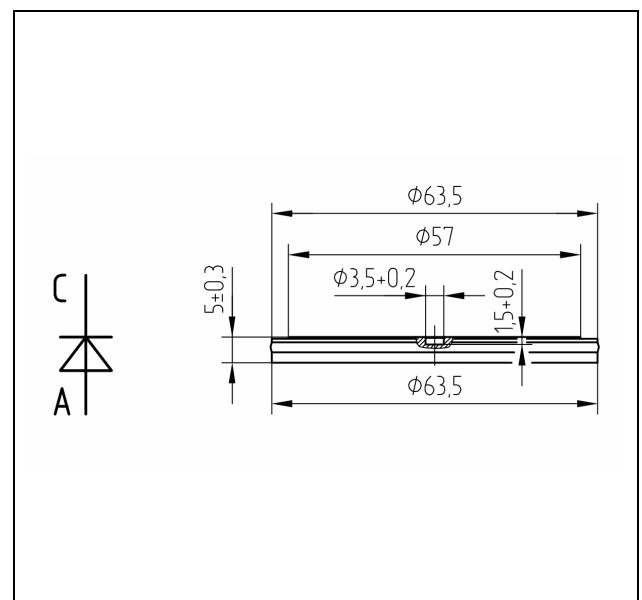

Fig. 1

Outline drawing.

All dimensions are in millimeters and represent nominal values unless stated otherwise.

ABB Switzerland Ltd, Semiconductors reserves the right to change specifications without notice.

On-state

I_{FAVM}	Max. average on-state current	13526 A	$T_c = 85\text{ °C}$	Half sine pulse
I_{FRMS}	Max. RMS on-state current	21247 A	$T_c = 85\text{ °C}$	Half sine pulse
I_{FSM}	Max. peak non-repetitive surge current	91000 A	$t_p = 8.3\text{ ms}$	$V_R = 0\text{ V}$
		85000 A	$t_p = 10\text{ ms}$	Half sine pulse
$\int i^2 dt$	Max. surge current integral	34200 kA^2s	$t_p = 8.3\text{ ms}$	$V_R = 0\text{ V}$
		36100 kA^2s	$t_p = 10\text{ ms}$	Half sine pulse
V_{Fmax}	Max. on-state voltage	0.920 V	$I_F = 8000\text{ A}$	
		0.970 V	$I_F = 10000\text{ A}$	
V_{F0}	Max. Threshold voltage	0.758 V		
r_F	Max. Slope resistance	0.021 $m\Omega$	$I_F = 10\ 000 \dots 30\ 000\text{ A}$	
Q_{rr}	Typ. Recovered charge	600 μC	$I_F = 1\ 000\text{ A}$, $di/dt = -30\text{ A}/\mu s$, $V_R = 100\text{ V}$	

Unless otherwise specified $T_j = 180\text{ °C}$

Thermal characteristics

T_j	Operating junction temperature range	-40...180 °C	
T_{stg}	Storage temperature range	-40...180 °C	
$R_{th(j-c)}$	Thermal resistance junction to case	5.2 KkW	Anode side cooled
		15.1 KkW	Cathode side cooled
		3.9 KkW	Double side cooled
$R_{th(c-h)}$	Thermal resistance case to heatsink	4.7 KkW	Anode side cooled
		5.8 KkW	Cathode side cooled
		2.6 KkW	Double side cooled

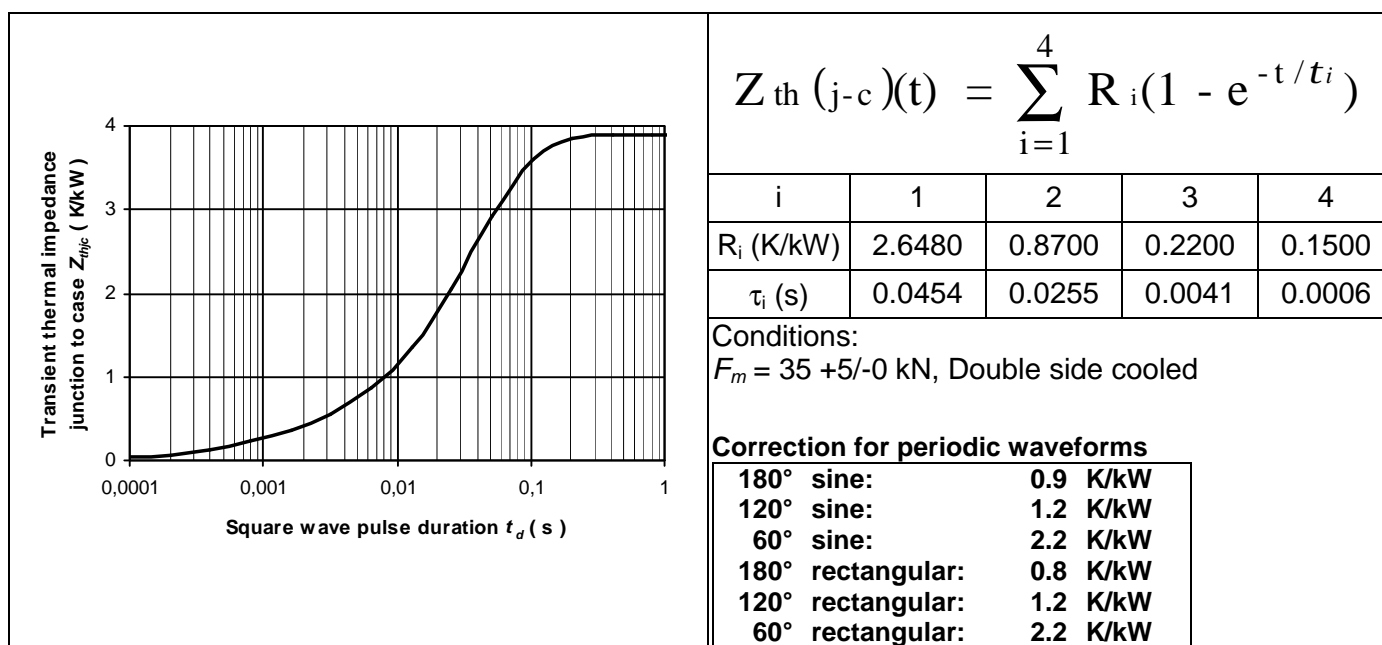

Fig. 2 Transient thermal impedance (junction-to-case) vs. time in analytical and graphical forms.

On-state characteristics

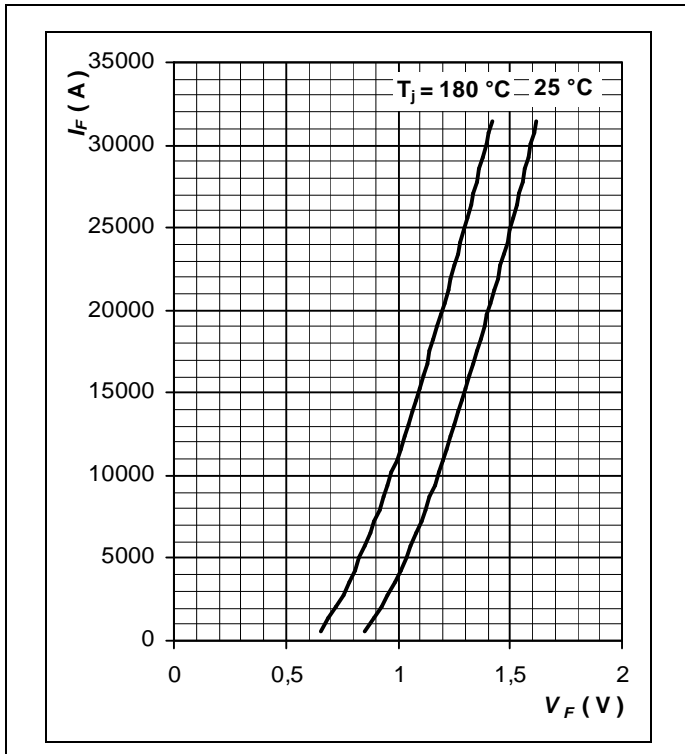

Fig. 3 Forward current vs. forward voltage (max. values).

Surge current characteristics

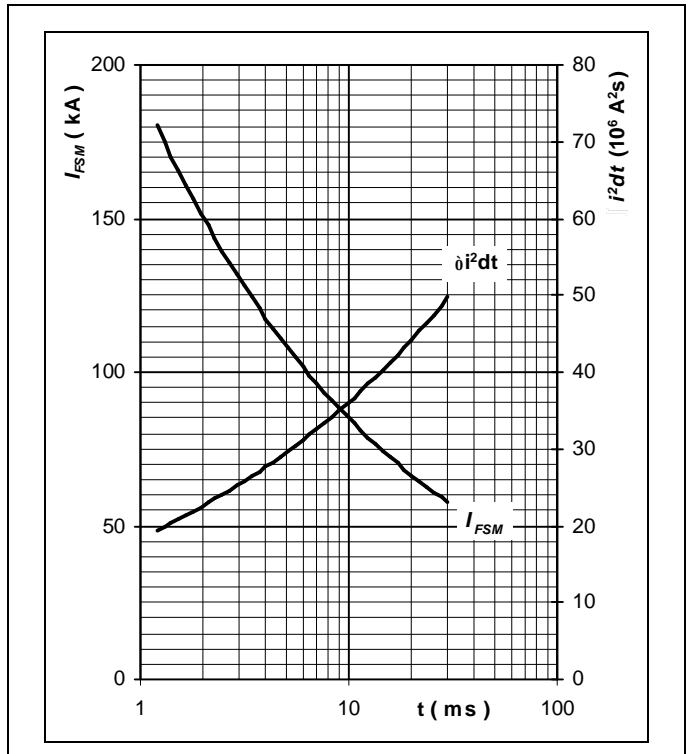

Fig. 4 Surge forward current vs. pulse length, half sine wave, single pulse, $V_R = 0 \text{ V}$, $T_j = T_{jmax}$

Surge current characteristics

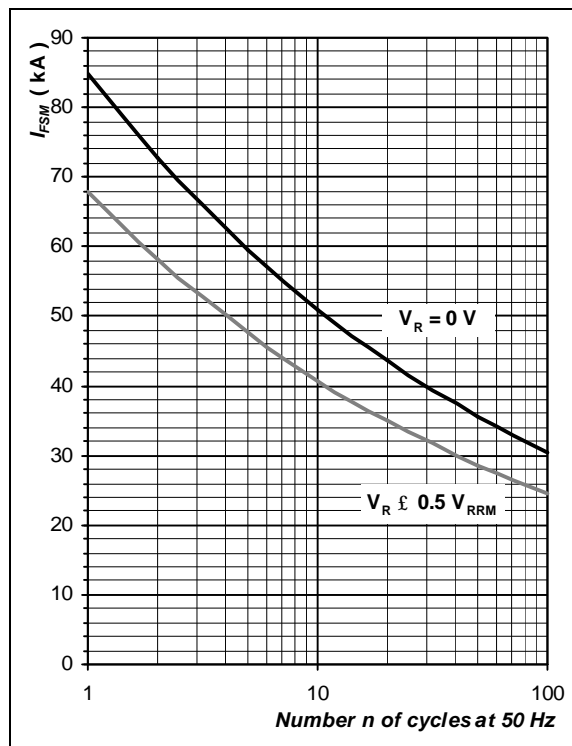

Fig. 5 Surge forward current vs. number of pulses, half sine wave, $T_j = T_{jmax}$

Forward power loss

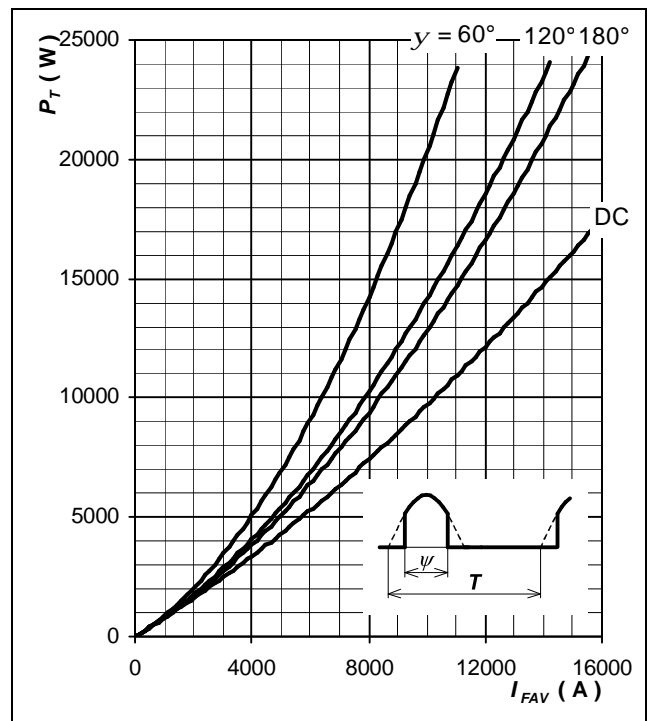

Fig. 6 Forward power loss vs. average forward current, sine waveform, $f = 50 \text{ Hz}$, $T = 1/f$

Forward power loss

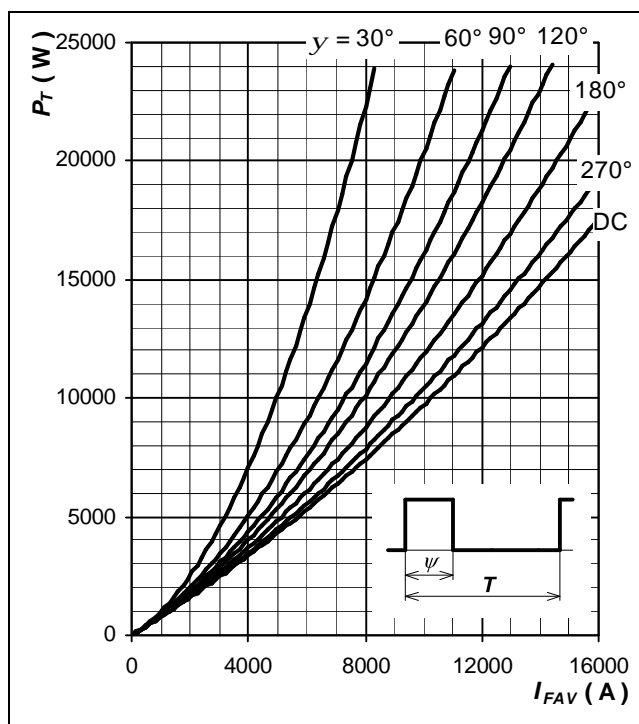

Fig. 7 Forward power loss vs. average forward current, square waveform, $f = 50 \text{ Hz}$, $T = 1/f$

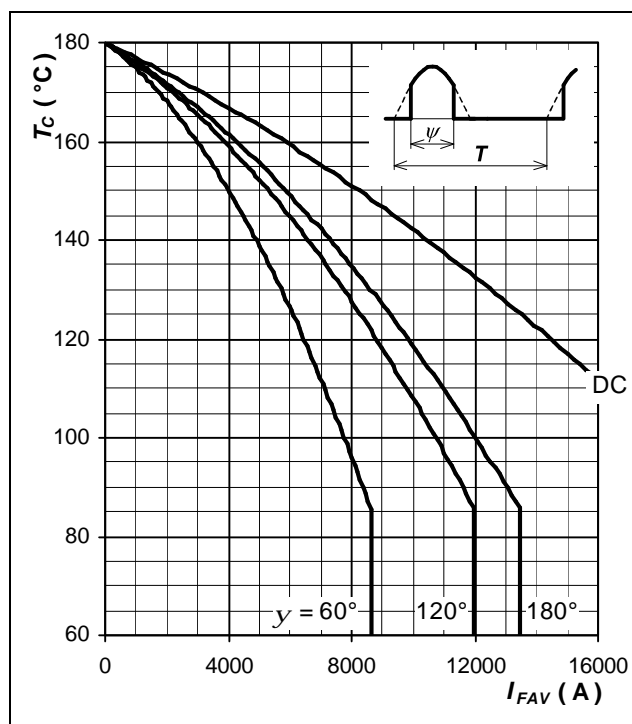

Fig. 8 Forward power loss vs. average forward current, sine waveform, $f = 50 \text{ Hz}$, $T = 1/f$

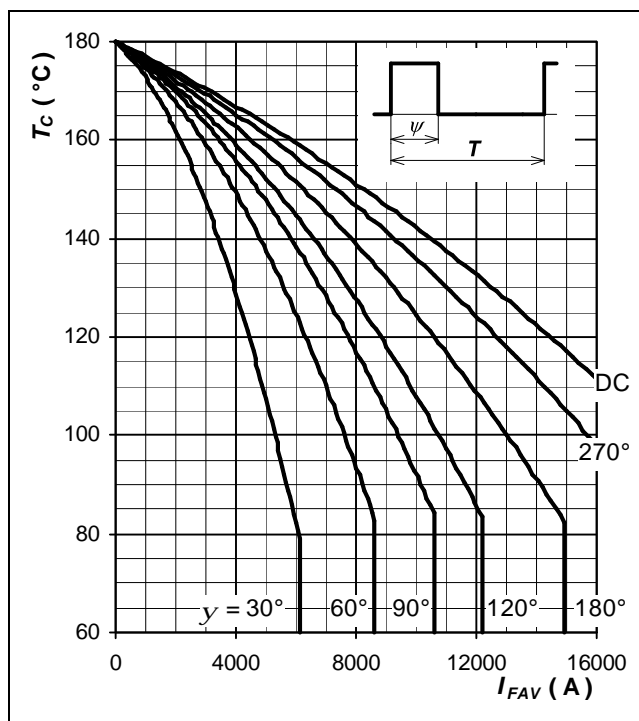

Fig. 9 Max. case temperature vs. aver. forward current, square waveform, $f = 50 \text{ Hz}$, $T = 1/f$

ABB Switzerland Ltd, Semiconductors reserves the right to change specifications without notice.



ABB Switzerland Ltd
Semiconductors
Fabrikstrasse 3
CH-5600 Lenzburg, Switzerland

Doc. No. 5SYA1179-00 March 07

Telephone +41 (0)58 586 1419
Fax +41 (0)58 586 1306
Email abbsem@ch.abb.com
Internet www.abb.com/semiconductors