

$I_{F(AV)} = 60\text{Amp}$   
 $V_R = 45\text{V}$

**Major Ratings and Characteristics**

Characteristics	Values	Units
$I_{F(AV)}$ Rectangular waveform (Per Device)	60	A
$I_{FRM}$ @ $T_C = 142^\circ\text{C}$ (Per Leg)	60	A
$V_{RRM}$	45	V
$I_{FSM}$ @ tp = 5 $\mu\text{s}$ sine	2600	A
$V_F$ @ 30Apk, $T_J = 125^\circ\text{C}$	0.57	V
$T_J$ range	-65 to 175	$^\circ\text{C}$

**Description/ Features**

This center tap Schottky rectifier has been optimized for low reverse leakage at high temperature. The proprietary barrier technology allows for reliable operation up to 175° C junction temperature. Typical applications are in switching power supplies, converters, free-wheeling diodes, and reverse battery protection.

- 175° C  $T_J$  operation
- Center tap TO-220 package
- Low forward voltage drop
- High purity, high temperature epoxy encapsulation for enhanced mechanical strength and moisture resistance
- High frequency operation
- Guard ring for enhanced ruggedness and long term reliability
- Lead-Free ("PbF" suffix)

**Case Styles**

61CTQ045PbF



TO-220

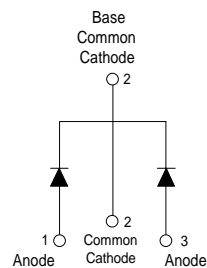

## Voltage Ratings

Parameters	61CTQ045PbF
$V_R$ Max. DC Reverse Voltage (V)	45
$V_{RWM}$ Max. Working Peak Reverse Voltage (V)	

## Absolute Maximum Ratings

Parameters	Values	Units	Conditions
$I_{F(AV)}$ Max. Average Forward Current (Per Leg) (Per Device)	30	A	@ $T_C = 142^\circ\text{C}$ , (Rated $V_R$ )
	60		
$I_{FRM}$ Peak Repetitive Forward Current (Per Leg)	60	A	Rated $V_R$ , square wave, 20kHz $T_C = 142^\circ\text{C}$
$I_{FSM}$ Max. Peak One Cycle Non-Repetitive Surge Current (Per Leg)	2600	A	5 $\mu\text{s}$ Sine or 3 $\mu\text{s}$ Rect. pulse 10ms Sine or 6ms Rect. pulse
	350		
$E_{AS}$ Non-Repetitive Avalanche Energy (Per Leg)	27	mJ	$T_J = 25^\circ\text{C}$ , $I_{AS} = 4\text{Amps}$ , $L = 3.4\text{mH}$
$I_{AR}$ Repetitive Avalanche Current (Per Leg)	4	A	Current decaying linearly to zero in 1 $\mu\text{sec}$ Frequency limited by $T_J$ max. $V_A = 1.5 \times V_R$ typical

## Electrical Specifications

Parameters	Typ.	Max.	Units	Conditions
$V_{FM}$ Max. Forward Voltage Drop (1)	0.57	0.61	V	@ 30A $T_J = 25^\circ\text{C}$
	0.72	0.76	V	@ 60A
	0.53	0.57	V	@ 30A $T_J = 125^\circ\text{C}$
	0.70	0.74	V	@ 60A
$I_{RM}$ Max. Instantaneous Reverse Current	0.06	1	mA	$T_J = 25^\circ\text{C}$ Rated DC voltage
	21	40	mA	$T_J = 125^\circ\text{C}$
$C_T$ Max. Junction Capacitance	1900		pF	$V_R = 5V_{DC}$ (test signal range 100Khz to 1Mhz) $25^\circ\text{C}$
$L_S$ Typical Series Inductance	8.0		nH	Measured from top of terminal to mounting plane
$dv/dt$ Max. Voltage Rate of Change (Rated $V_R$ )	10000		V/ $\mu\text{s}$	

(1) Pulse Width < 300 $\mu\text{s}$ , Duty Cycle <2%

## Thermal-Mechanical Specifications

Parameters	Values	Units	Conditions
$T_J$ Max. Junction Temperature Range	-65 to 175	$^\circ\text{C}$	
$T_{stg}$ Max. Storage Temperature Range	-65 to 175	$^\circ\text{C}$	
$R_{thJC}$ Max. Thermal Resistance Junction to Case (Per Leg)	1.2	$^\circ\text{C/W}$	DC operation
$R_{thCS}$ Typical Thermal Resistance Case to Heatsink	0.50	$^\circ\text{C/W}$	Mounting surface, smooth and greased
wt Approximate Weight	2 (0.07)	g (oz.)	
T Mounting Torque	Min. 6 (5)	Kg-cm (lbf-in)	Non-lubricated threads
	Max. 12 (10)		
Marking Device	61CTQ045		

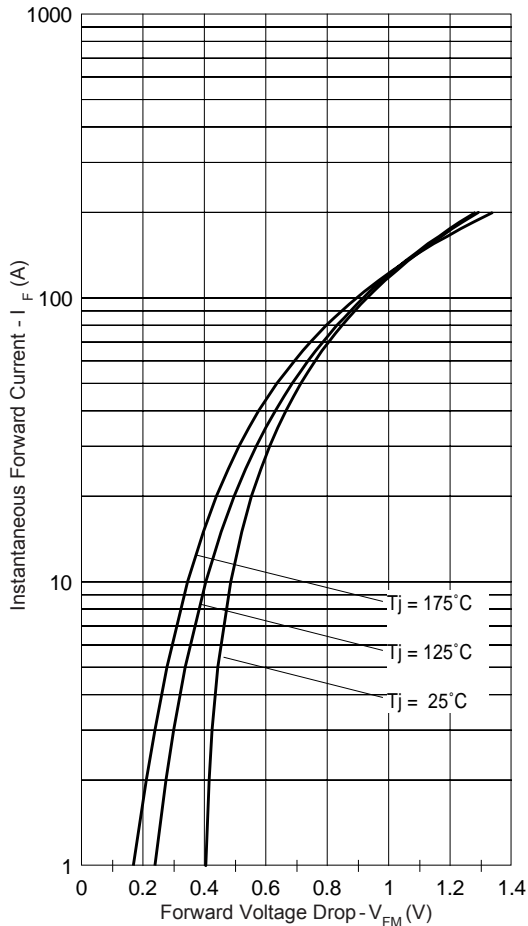

Fig. 1 - Maximum Forward Voltage Drop Characteristics

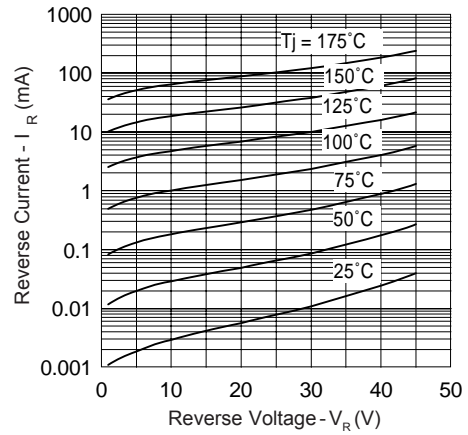

Fig. 2 - Typical Values of Reverse Current Vs. Reverse Voltage

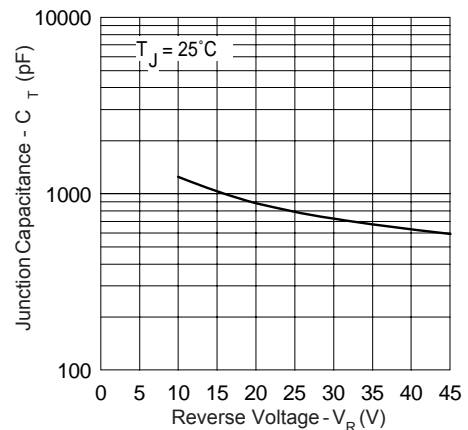

Fig. 3 - Typical Junction Capacitance Vs. Reverse Voltage

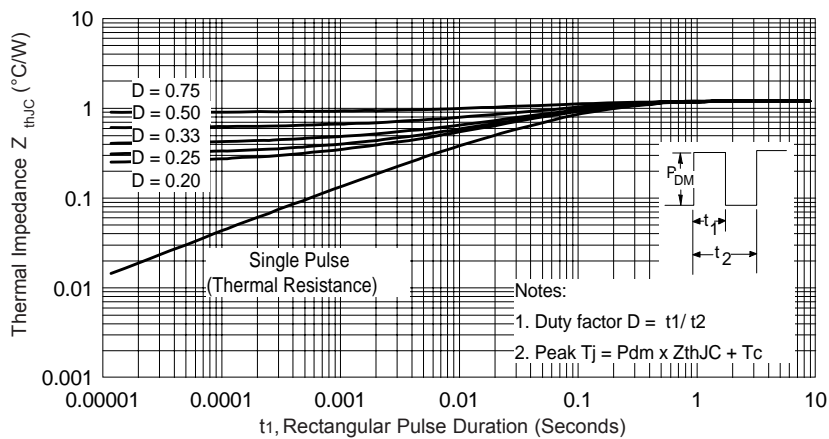

Fig. 4 - Max. Thermal Impedance  $Z_{thJC}$  Characteristics

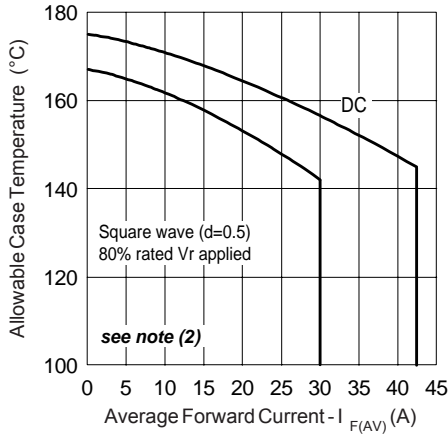

Fig. 5 - Max. Allowable Case Temperature Vs. Average Forward Current

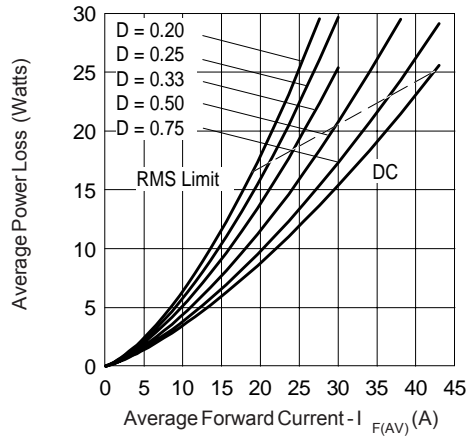

Fig. 6 - Forward Power Loss Characteristics

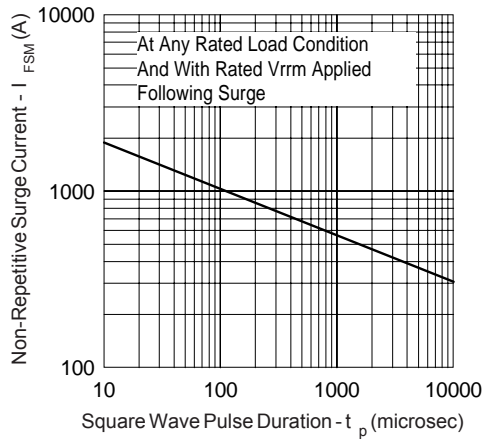
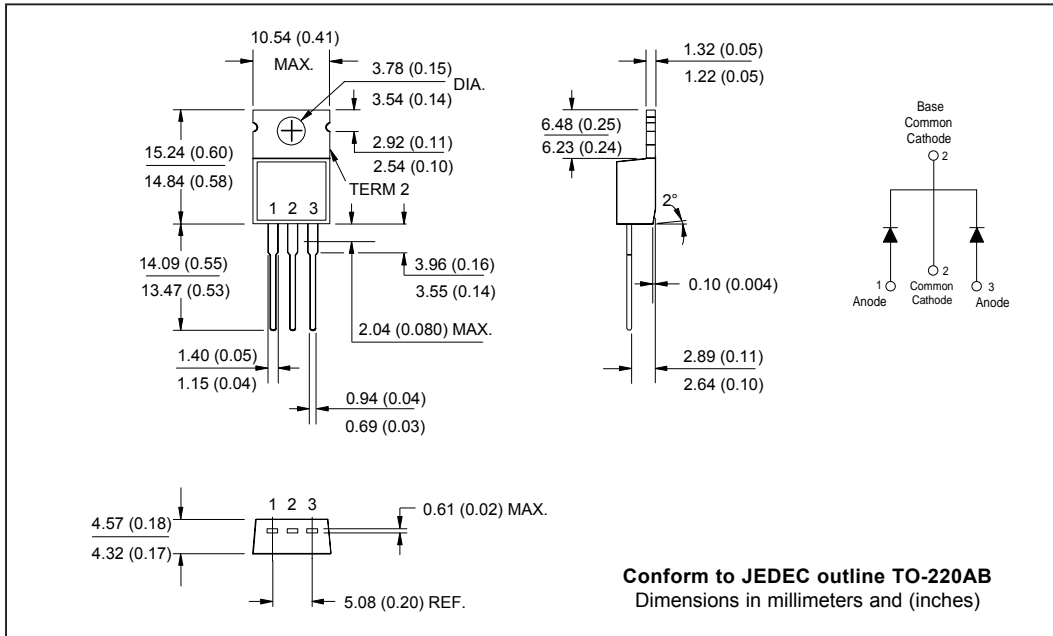

Fig. 7 - Max. Non-Repetitive Surge Current (Per Leg)

- (2) Formula used:  $T_c = T_j - (P_d + P_{d_{REV}}) \times R_{thJC}$ ;  
 $P_d = \text{Forward Power Loss} = I_{F(AV)} \times V_{FM} @ (I_{F(AV)} / D)$  (see Fig. 6);  
 $P_{d_{REV}} = \text{Inverse Power Loss} = V_{R1} \times I_R (1 - D)$ ;  $I_R @ V_{R1} = 80\% \text{ rated } V_R$

Outline Table



Part Marking Information

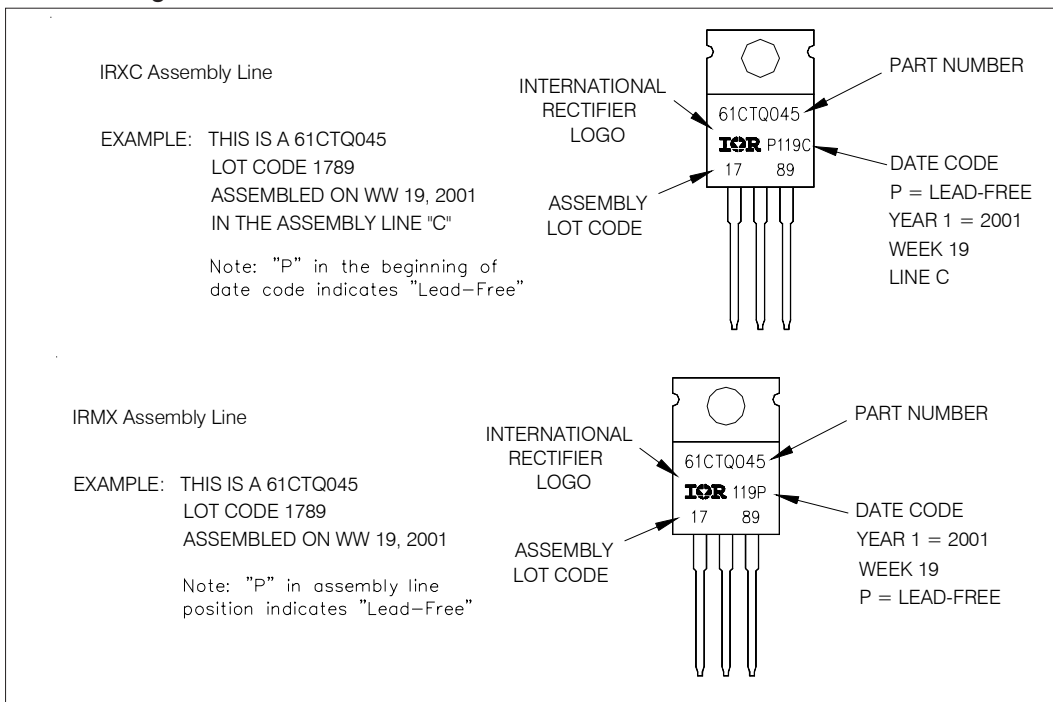

## Ordering Information Table

Device Code													
	<table border="1" style="margin: auto;"> <tr> <td style="padding: 5px;">61</td> <td style="padding: 5px;">C</td> <td style="padding: 5px;">T</td> <td style="padding: 5px;">Q</td> <td style="padding: 5px;">045</td> <td style="padding: 5px;">PbF</td> </tr> <tr> <td style="text-align: center;">①</td> <td style="text-align: center;">②</td> <td style="text-align: center;">③</td> <td style="text-align: center;">④</td> <td style="text-align: center;">⑤</td> <td style="text-align: center;">⑥</td> </tr> </table>	61	C	T	Q	045	PbF	①	②	③	④	⑤	⑥
61	C	T	Q	045	PbF								
①	②	③	④	⑤	⑥								
<b>1</b>	- Current Rating (60 = 60A)												
<b>2</b>	- Circuit Configuration C = Common Cathode												
<b>3</b>	- Package T = TO-220												
<b>4</b>	- Schottky "Q" Series												
<b>5</b>	- Voltage Rating (045 = 45V)												
<b>6</b>	- <ul style="list-style-type: none"> <li>• none = Standard Production</li> <li>• PbF = Lead-Free</li> </ul>												
Tube Standard Pack Quantity : 50 pieces													

Data and specifications subject to change without notice.  
This product has been designed and qualified for Industrial Level and Lead-Free.  
Qualification Standards can be found on IR's Web site.