

74LVX373

Low Voltage Octal Transparent Latch with 3-STATE Outputs

General Description

The LVX373 consists of eight latches with 3-STATE outputs for bus organized system applications. The latches appear transparent to the data when Latch Enable (LE) is HIGH. When LE is LOW, the data satisfying the input timing requirements is latched. Data appears on the bus when the Output Enable (\overline{OE}) is LOW. When \overline{OE} is HIGH, the bus output is in the high impedance state. The inputs tolerate up to 7V allowing interface of 5V systems to 3V systems.

Features

- Input voltage translation from 5V to 3V
- Ideal for low power/low noise 3.3V applications
- Guaranteed simultaneous switching noise level and dynamic threshold performance

Ordering Code:

Order Number	Package Number	Package Description
74LVX373M	M20B	20-Lead Small Outline Integrated Circuit (SOIC), JEDEC MS-013, 0.300" Wide
74LVX373SJ	M20D	Pb-Free 20-Lead Small Outline Package (SOP), EIAJ TYPE II, 5.3mm Wide
74LVX373MTC	MTC20	20-Lead Thin Shrink Small Outline Package (TSSOP), JEDEC MO-153, 4.4mm Wide

Devices also available in Tape and Reel. Specify by appending suffix letter "X" to the ordering code.
Pb-Free package per JEDEC J-STD-020B.

Logic Symbols

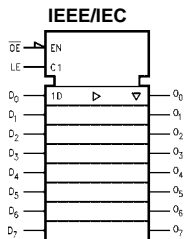
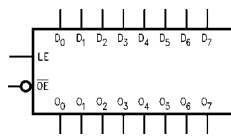

Connection Diagram

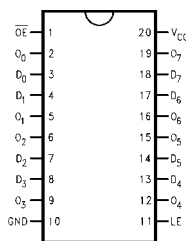

Pin Descriptions

Pin Names	Description
D ₀ -D ₇	Data Inputs
LE	Latch Enable Input
\overline{OE}	Output Enable Input
O ₀ -O ₇	3-STATE Latch Outputs

Truth Table

Inputs			Outputs
LE	\overline{OE}	D _n	O _n
X	H	X	Z
H	L	L	L
H	L	H	H
L	L	X	O ₀

H = HIGH Voltage Level
L = LOW Voltage Level
Z = High Impedance
X = Immaterial
O₀ = Previous O₀ before HIGH-to-LOW transition of Latch Enable

74LVX373 Low Voltage Octal Transparent Latch with 3-STATE Outputs

Functional Description

The LVX373 contains eight D-type latches with 3-STATE standard outputs. When the Latch Enable (LE) input is HIGH, data on the D_n inputs enters the latches. In this condition the latches are transparent, i.e., a latch output will change state each time its D input changes. When LE is LOW, the latches store the information that was present on the D inputs a setup time preceding the HIGH-to-LOW tran-

sition of LE. The 3-STATE standard outputs are controlled by the Output Enable (\overline{OE}) input. When \overline{OE} is LOW, the standard outputs are in the 2-state mode. When \overline{OE} is HIGH, the standard outputs are in the high impedance mode but this does not interfere with entering new data into the latches.

Logic Diagram

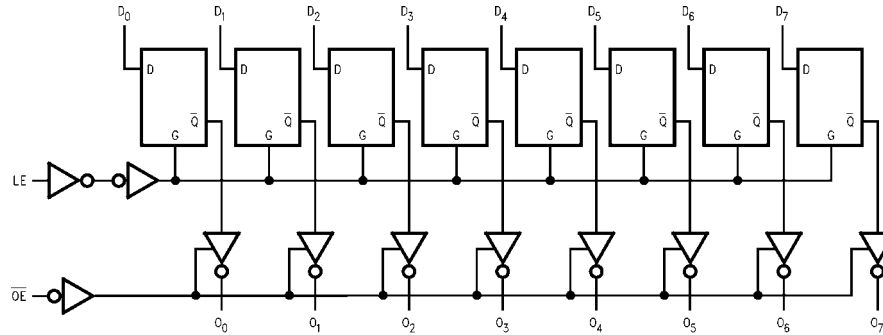

Please note that this diagram is provided only for the understanding of logic operations and should not be used to estimate propagation delays.

Absolute Maximum Ratings(Note 1)

Supply Voltage (V_{CC})	-0.5V to +7.0V
DC Input Diode Current (I_{IK})	
$V_I = -0.5V$	-20 mA
DC Input Voltage (V_I)	-0.5V to 7V
DC Output Diode Current (I_{OK})	
$V_O = -0.5V$	-20 mA
$V_O = V_{CC} + 0.5V$	+20 mA
DC Output Voltage (V_O)	-0.5V to $V_{CC} + 0.5V$
DC Output Source	
or Sink Current (I_O)	± 25 mA
DC V_{CC} or Ground Current	
(I_{CC} or I_{GND})	± 75 mA
Storage Temperature (T_{STG})	-65°C to +150°C
Power Dissipation	180 mW

Recommended Operating Conditions (Note 2)

Supply Voltage (V_{CC})	2.0V to 3.6V
Input Voltage (V_I)	0V to 5.5V
Output Voltage (V_O)	0V to V_{CC}
Operating Temperature (T_A)	-40°C to +85°C
Input Rise and Fall Time ($\Delta t/\Delta V$)	0 ns/V to 100 ns/V

Note 1: The "Absolute Maximum Ratings" are those values beyond which the safety of the device cannot be guaranteed. The device should not be operated at these limits. The parametric values defined in the Electrical Characteristics tables are not guaranteed at the absolute maximum ratings. The "Recommended Operating Conditions" table will define the conditions for actual device operation.

Note 2: Unused inputs must be held HIGH or LOW. They may not float.

DC Electrical Characteristics

Symbol	Parameter	V_{CC}	$T_A = +25^\circ\text{C}$			$T_A = -40^\circ\text{C to } +85^\circ\text{C}$		Units	Conditions
			Min	Typ	Max	Min	Max		
V_{IH}	HIGH Level Input Voltage	2.0	1.5			1.5		V	
		3.0	2.0			2.0			
		3.6	2.4			2.4			
V_{IL}	LOW Level Input Voltage	2.0			0.5		0.5	V	
		3.0			0.8		0.8		
		3.6			0.8		0.8		
V_{OH}	HIGH Level Output Voltage	2.0	1.9	2.0		1.9		V	$V_{IN} = V_{IH}$ or V_{IL} $I_{OH} = -50 \mu\text{A}$ $I_{OH} = -50 \mu\text{A}$ $I_{OH} = -4 \text{mA}$
		3.0	2.9	3.0		2.9			
		3.0	2.58			2.48			
V_{OL}	LOW Level Output Voltage	2.0		0.0	0.1		0.1	V	$V_{IN} = V_{IH}$ or V_{IL} $I_{OL} = 50 \mu\text{A}$ $I_{OL} = 50 \mu\text{A}$ $I_{OL} = 4 \text{mA}$
		3.0		0.0	0.1		0.1		
		3.0			0.36		0.44		
I_{OZ}	3-STATE Output Off-State Current	3.6			± 0.25		± 2.5	μA	$V_{IN} = V_{IH}$ or V_{IL} $V_{OUT} = V_{CC}$ or GND
I_{IN}	Input Leakage Current	3.6			± 0.1		± 1.0	μA	$V_{IN} = 5.5V$ or GND
I_{CC}	Quiescent Supply Current	3.6			4.0		40.0	μA	$V_{IN} = V_{CC}$ or GND

Noise Characteristics (Note 3)

Symbol	Parameter	V_{CC} (V)	$T_A = 25^\circ\text{C}$		Units	C_L (pF)
			Typ	Limit		
V_{OLP}	Quiet Output Maximum Dynamic V_{OL}	3.3	0.5	0.8	V	50
V_{OLV}	Quiet Output Minimum Dynamic V_{OL}	3.3	-0.5	-0.8	V	50
V_{IHD}	Minimum HIGH Level Dynamic Input Voltage	3.3		2.0	V	50
V_{ILD}	Maximum LOW Level Dynamic Input Voltage	3.3		0.8	V	50

Note 3: Input $t_r = t_f = 3$ ns.

AC Electrical Characteristics

Symbol	Parameter	V _{CC} (V)	T _A = +25°C			T _A = -40°C to +85°C		Units	Conditions
			Min	Typ	Max	Min	Max		
t _{PLH} t _{PHL}	Propagation Delay Time D _n to O _n	2.7	7.7	15.0	1.0	18.5	ns	C _L = 15 pF	
			10.2	18.5	1.0	22.0		C _L = 50 pF	
		3.3 ± 0.3	6.0	9.7	1.0	11.5		C _L = 15 pF	
			8.5	13.2	1.0	15.0		C _L = 50 pF	
t _{PLH} t _{PHL}	Propagation Delay Time LE to O _n	2.7	7.5	14.5	1.0	17.5	ns	C _L = 15 pF	
			10.0	18.0	1.0	21.0		C _L = 50 pF	
		3.3 ± 0.3	5.8	9.3	1.0	11.0		C _L = 15 pF	
			8.3	12.8	1.0	14.5		C _L = 50 pF	
t _{PZL} t _{PZH}	3-STATE Output Enable Time	2.7	7.7	15.0	1.0	18.5	ns	C _L = 15 pF, R _L = 1 kΩ	
			10.2	18.5	1.0	22.0		C _L = 50 pF, R _L = 1 kΩ	
		3.3 ± 0.3	6.0	9.7	1.0	11.5		C _L = 15 pF, R _L = 1 kΩ	
			8.5	13.2	1.0	15.0		C _L = 50 pF, R _L = 1 kΩ	
t _{PLZ} t _{PHZ}	3-STATE Output Disable Time	2.7	9.8	18.0	1.0	21.0	ns	C _L = 50 pF, R _L = 1 kΩ	
		3.3 ± 0.3	8.2	12.8	1.0	14.5		C _L = 50 pF, R _L = 1 kΩ	
t _W	LE Pulse Width, HIGH	2.7	6.5		7.5		ns		
		3.3 ± 0.3	5.0		5.0				
t _S	Setup Time, D _n to LE	2.7	6.0		6.0		ns		
		3.3 ± 0.3	4.0		4.0				
t _H	Hold Time, D _n to LE	2.7	1.0		1.0		ns		
		3.3 ± 0.3	1.0		1.0				
t _{OSLH} t _{OSHL}	Output to Output Skew (Note 4)	2.7		1.5		1.5	ns	C _L = 50 pF	
		3.3		1.5		1.5			

Note 4: Parameter guaranteed by design. t_{OSLH} = |t_{PLHm} - t_{PLHn}|, t_{OSHL} = |t_{PHLm} - t_{PHLn}|

Capacitance

Symbol	Parameter	T _A = +25°C			T _A = -40°C to +85°C		Units
		Min	Typ	Max	Min	Max	
C _{IN}	Input Capacitance		4	10			pF
C _{OUT}	Output Capacitance		6				pF
C _{PD}	Power Dissipation Capacitance (Note 5)		27				pF

Note 5: C_{PD} is defined as the value of the internal equivalent capacitance which is calculated from the operating current consumption without load.

$$\text{Average operating current can be obtained by the equation: } I_{CC(\text{opr})} = \frac{C_{PD} \times V_{CC} \times f_{IN} + I_{CC}}{8 \text{ (per Latch)}}$$

Physical Dimensions inches (millimeters) unless otherwise noted (Continued)

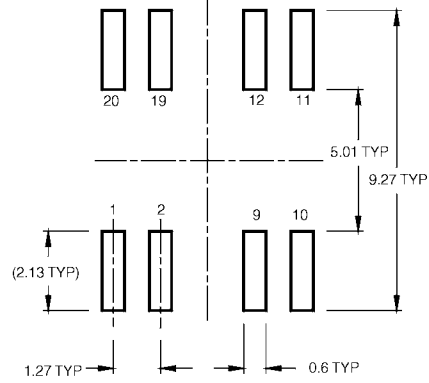
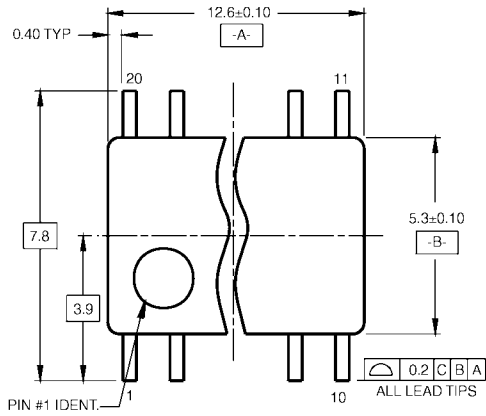

LAND PATTERN RECOMMENDATION

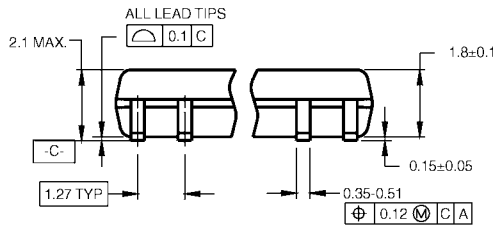

DIMENSIONS ARE IN MILLIMETERS

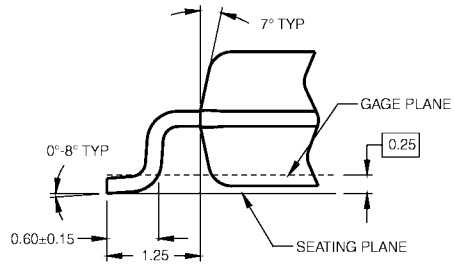
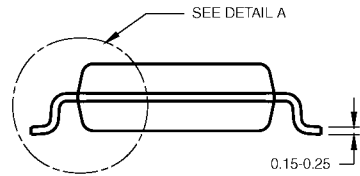

DETAIL A

- NOTES:
- A. CONFORMS TO EIAJ EDR-7320 REGISTRATION, ESTABLISHED IN DECEMBER, 1998.
 - B. DIMENSIONS ARE IN MILLIMETERS.
 - C. DIMENSIONS ARE EXCLUSIVE OF BURRS, MOLD FLASH, AND TIE BAR EXTRUSIONS.

M20DRevB1

Pb-Free 20-Lead Small Outline Package (SOP), EIAJ TYPE II, 5.3mm Wide Package Number M20D

Physical Dimensions inches (millimeters) unless otherwise noted (Continued)

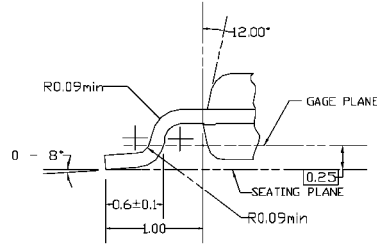
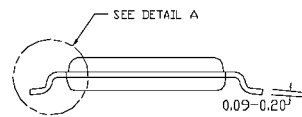
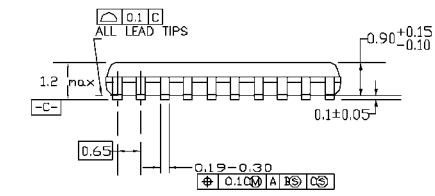
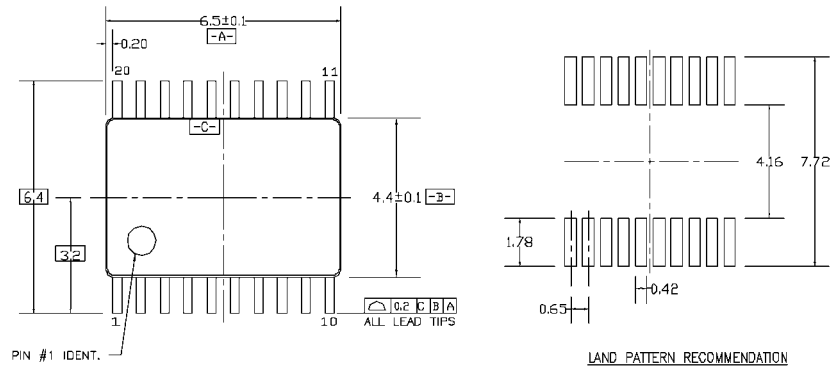

DIMENSIONS ARE IN MILLIMETERS

NOTES:

- A. CONFORMS TO JEDEC REGISTRATION MO-153, VARIATION AC, REF NOTE 6, DATE 7/93.
- B. DIMENSIONS ARE IN MILLIMETERS.
- C. DIMENSIONS ARE EXCLUSIVE OF BURRS, MOLDS FLASH, AND TIE BAR EXTRUSIONS.
- D. DIMENSIONS AND TOLERANCES PER ANSI Y14.5M, 1982.

MTC20REV D1

20-Lead Thin Shrink Small Outline Package (TSSOP), JEDEC MO-153, 4.4mm Wide Package Number MTC20

Fairchild does not assume any responsibility for use of any circuitry described, no circuit patent licenses are implied and Fairchild reserves the right at any time without notice to change said circuitry and specifications.

LIFE SUPPORT POLICY

FAIRCHILD'S PRODUCTS ARE NOT AUTHORIZED FOR USE AS CRITICAL COMPONENTS IN LIFE SUPPORT DEVICES OR SYSTEMS WITHOUT THE EXPRESS WRITTEN APPROVAL OF THE PRESIDENT OF FAIRCHILD SEMICONDUCTOR CORPORATION. As used herein:

1. Life support devices or systems are devices or systems which, (a) are intended for surgical implant into the body, or (b) support or sustain life, and (c) whose failure to perform when properly used in accordance with instructions for use provided in the labeling, can be reasonably expected to result in a significant injury to the user.
2. A critical component in any component of a life support device or system whose failure to perform can be reasonably expected to cause the failure of the life support device or system, or to affect its safety or effectiveness.

www.fairchildsemi.com