

Resin-Molded, Radial-Lead Solid Tantalum Capacitors

FEATURES

- Four case sizes precisely molded with a flame retardant epoxy resin
- Stand off on all case sizes
- Available on tape for automatic insertion equipment (only A- and B-case, C- and D-case on request).
- Low leakage current
- Low impedance
- Extended value ranges available

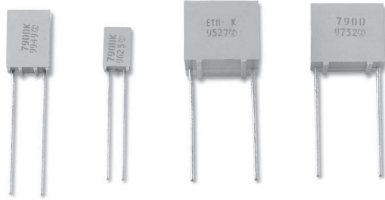

PERFORMANCE CHARACTERISTICS

Operating temperature range: - 55°C to + 125°C

ORDERING INFORMATION						
790D MODEL	157 CAPACITANCE	X0 CAPACITANCE TOLERANCE	006 DC VOLTAGE RATING AT + 85°C	R CASE CODE	2 STYLE NUMBER	P PACKAGING
Expressed in picofarads. First two digits are significant figures. Third digit is the number of zeros to follow.		X0 = ± 20% X9 = ± 10%	Expressed in volts. To complete the three-digit block, zeros precede the voltage rating. A decimal point is indicated by an "R" (6R3 = 6.3 Volts)	See Ratings and Case Codes Table.	Insulated Case (Standard)	
790D = Standard and Extended Range					See Taping Specification B : Bulk G : Ammopack H = 16.5mm H : Ammopack H = 18.5mm I : Ammopack Shouldered Leads (A case) X : Reel Pack H = 16.5mm Y : Reel Pack H = 18.5mm Z : Reel Pack Shouldered Leads (A case)	

DIMENSIONS in millimeters

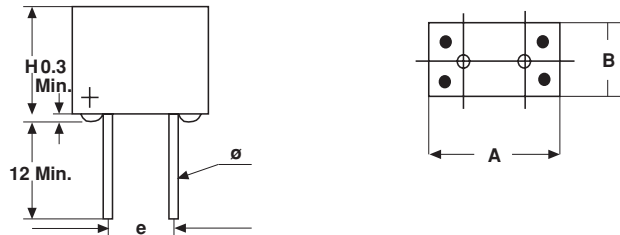

CASE CODE	H MAX. (mm)	A MAX. (mm)	B MAX. (mm)	E ± 0.15 (mm)	Ø 0.05 (+ 10%) (mm)
A	7.3	4.7	4.2	2.54	0.5
B	10.5	7.3	4.8	5.08	0.5
C	10.5	12.3	7.3	10.16	0.6
D	10.5	12.3	12.3	10.16	0.6

PACKAGING QUANTITIES

CASE CODE	REEL X/Y	AMMO G/H	BULK B
A	1000	1000	500
B	1000	1000	250
C	300*	300*	100
D	200*	200*	50

*Non preferred configuration on request only



RATINGS AND CASE CODES																	
C _R μF	RATED VOLATAGE U _R @ + 85°C																
	6.3V		10V		16V		20V		25V		35V		40V		50V		
	CATEGORY VOLTAGE U _C @ +125°C																
	4.0V		6.3V		10V		13V		16V		23V		25V		32V		
	Std.	Ext.	Std.	Ext.	Std.	Ext.	Std.	Ext.	Std.	Ext.	Std.	Ext.	Std.	Ext.	Std.	Ext.	
0.10															A		A
0.15																	A
0.22																	A
0.33															A		
0.47															A		
0.68																	
1.0															A		A
1.5									A						B		B
2.2					A		A								B		B
3.3					A								A		B		B
4.7			A							A					B		B
6.8	A							A							B		C
10						A			B				B		C		C
15				A	B		B			B					C		C
22		A			B			B		B					C		
33			B			B			C				C				
47	B			B	C			C									
68		B		B	C			C									
100			C		D	C											
150	C			C													
220		C	D														
330	D																



Resin-Coated, Radial-Leaded
Solid Tantalum Capacitors

Vishay Sprague

STANDARD/EXTENDED RATINGS					
CAPACITANCE C _R (μF)	CASE CODE	PART NUMBER	MAX. DCL @ + 25°C (μA)	MAX. DF 120Hz, @ + 25°C (%)	MAX. IMPEDANCE 100kHz, @ + 25°C (OHMS)
U_R = 6.3 Volt @ + 85°C, SURGE = 8 V			U_C = 4 V @ + 125°C, SURGE = 5 V		
6.8	A	790D685X(*)6R3A2(#)	1.0	6	4.0
22.0	A	790D226X(*)6R3A2(#)	1.3	6	2.1
47.0	B	790D476X(*)6R3B2(#)	2.9	6	1.3
68.0	B	790D686X(*)6R3B2(#)	4.2	6	1.3
150.0	C	790D157X(*)6R3C2(#)	9.4	6	0.6
220.0	C	790D227X(*)6R3C2(#)	13.8	6	0.6
330.0	D	790D337X(*)6R3D2(#)	20.7	8	0.4
U_R = 10 Volt @ + 85°C, SURGE = 13 V			U_C = 6.3 V @ + 125°C, SURGE = 8 V		
4.7	A	790D475X(*)010A2(#)	1.0	6	4.0
15.0	A	790D156X(*)010A2(#)	1.5	6	2.5
33.0	B	790D336X(*)010B2(#)	3.3	6	1.3
47.0	B	790D476X(*)010B2(#)	4.7	6	1.4
68.0	B	790D686X(*)010B2(#)	6.8	6	1.3
100.0	C	790D107X(*)010C2(#)	10.0	6	0.6
150.0	C	790D157X(*)010C2(#)	15.0	6	0.6
220.0	D	790D227X(*)010D2(#)	22.0	8	0.4
U_R = 16 Volt @ + 85°C, SURGE = 20 V			U_C = 10 V @ + 125°C, SURGE = 13 V		
2.2	A	790D225X(*)016A2(#)	1.0	6	5.5
3.3	A	790D335X(*)016A2(#)	1.0	6	4.4
10.0	A	790D106X(*)016A2(#)	1.6	6	2.7
15.0	B	790D156X(*)016B2(#)	2.4	6	1.6
22.0	B	790D226X(*)016B2(#)	3.5	6	1.3
33.0	B	790D336X(*)016B2(#)	5.2	6	1.6
47.0	C	790D476X(*)016C2(#)	7.5	6	0.8
68.0	C	790D686X(*)016C2(#)	10.8	6	0.6
100.0	C	790D107X(*)016C2(#)	16.0	6	0.7
100.0	D	790D107X(*)016D2(#)	16.0	6	0.5
U_R = 20 Volt @ + 85°C, SURGE = 26 V			U_C = 13 V @ + 125°C, SURGE = 16 V		
2.2	A	790D225X(*)020A2(#)	1.0	6	5.5
6.8	A	790D685X(*)020A2(#)	1.3	6	3.5
15.0	B	790D156X(*)020B2(#)	3.0	6	1.5
22.0	B	790D226X(*)020B2(#)	4.4	6	2.1
47.0	C	790D476X(*)020C2(#)	9.4	6	0.7
68.0	C	790D686X(*)020C2(#)	13.6	6	0.8

Extended Ratings in bold print.

(*)Insert 0 for ± 20% tolerance or 9 for ± 10%

(#)See order information, packaging code

STANDARD/EXTENDED RATINGS

CAPACITANCE C_R (μ F)	CASE CODE	PART NUMBER	MAX. DCL @ + 25°C (μ A)	MAX. DF 120Hz, @ + 25°C (%)	MAX. IMPEDANCE 100kHz, @ + 25°C (OHMS)
$U_R = 25$ Volt @ + 85°C, SURGE = 32 V $U_C = 16$ V @ + 125°C, SURGE = 20 V					
1.5	A	790D155X(*)025A2(#)	1.0	6	6.0
4.7	A	790D475X(*)025A2(#)	1.1	6	4.5
10.0	B	790D106X(*)025B2(#)	2.5	6	1.6
15.0	B	790D156X(*)025B2(#)	3.7	6	2.4
22.0	B	790D226X(*)025B2(#)	5.5	6	2.1
33.0	C	790D336X(*)025C2(#)	8.2	6	0.8
$U_R = 35$ Volt @ + 85°C, SURGE = 45 V $U_C = 23$ V @ + 125°C, SURGE = 29 V					
3.3	A	790D335X(*)035A2(#)	1.2	6	6.0
10.0	B	790D106X(*)035B2(#)	3.5	6	2.6
33.0	C	790D336X(*)035C2(#)	11.6	6	1.3
$U_R = 40$ Volt @ + 85°C, SURGE = 52 V $U_C = 25$ V @ + 125°C, SURGE = 32 V					
0.10	A	790D104X(*)040A2(#)	1.0	6	30
0.33	A	790D334X(*)040A2(#)	1.0	6	14
0.47	A	790D474X(*)040A2(#)	1.0	6	11
1.0	A	790D105X(*)040A2(#)	1.0	6	6.5
1.5	B	790D155X(*)040B2(#)	1.0	6	5.2
2.2	B	790D225X(*)040B2(#)	1.0	6	4.0
3.3	B	790D335X(*)040B2(#)	1.3	6	2.8
4.7	B	790D475X(*)040B2(#)	1.8	6	2.0
6.8	B	790D685X(*)040B2(#)	2.7	6	1.6
10.0	C	790D106X(*)040C2(#)	4.0	6	1.3
15.0	C	790D156X(*)040C2(#)	6.0	6	1.0
22.0	C	790D226X(*)040C2(#)	8.8	6	0.8
$U_R = 50$ Volt @ + 85°C, SURGE = 65 V $U_C = 32$ V @ + 125°C, SURGE = 41 V					
0.10	A	790D104X(*)050A2(#)	1.0	6	30
0.15	A	790D154X(*)050A2(#)	1.0	6	24
0.22	A	790D224X(*)050A2(#)	1.0	6	18
1.0	A	790D105X(*)050A2(#)	1.0	6	6.5
1.5	B	790D155X(*)050B2(#)	1.0	6	5.2
2.2	B	790D225X(*)050B2(#)	1.1	6	4.0
3.3	B	790D335X(*)050B2(#)	1.6	6	2.8
4.7	B	790D475X(*)050B2(#)	2.3	6	2.0
6.8	C	790D685X(*)050C2(#)	3.4	6	1.6
10.0	C	790D106X(*)050C2(#)	5.0	6	1.3
15.0	C	790D156X(*)050C2(#)	7.5	6	1.0

Extended Ratings in bold print.

(*) Insert 0 for $\pm 20\%$ tolerance or 9 for $\pm 10\%$

#) See order information, packaging code



MAXIMUM PERMISSIBLE RIPPLE VOLTAGE AT + 25°C

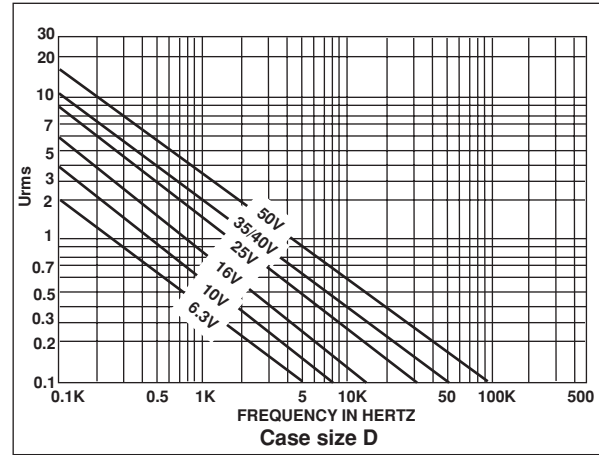
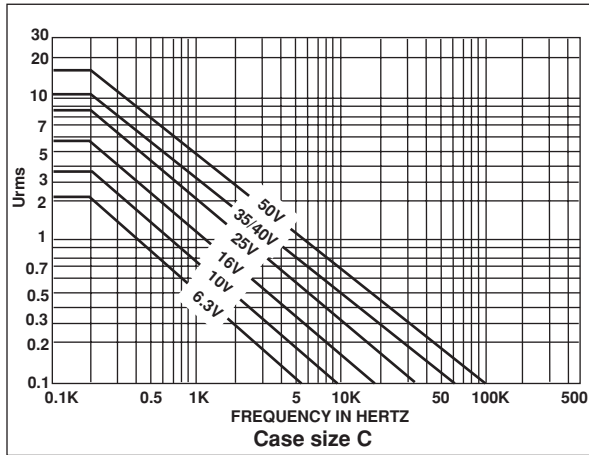
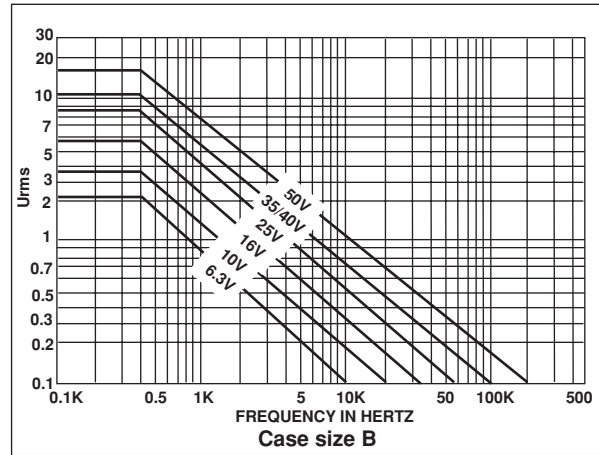
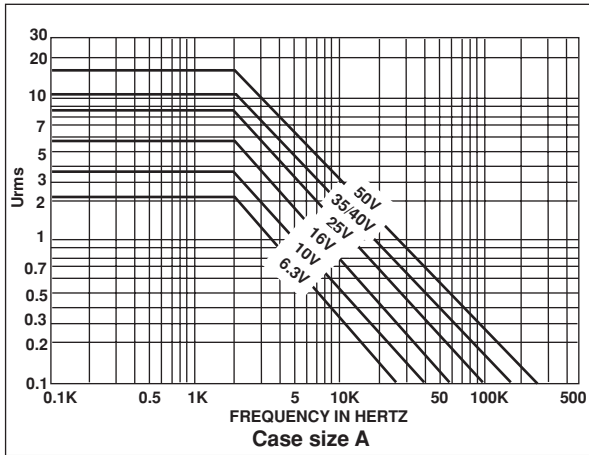

TYPICAL CURVES OF IMPEDANCE VS FREQUENCY

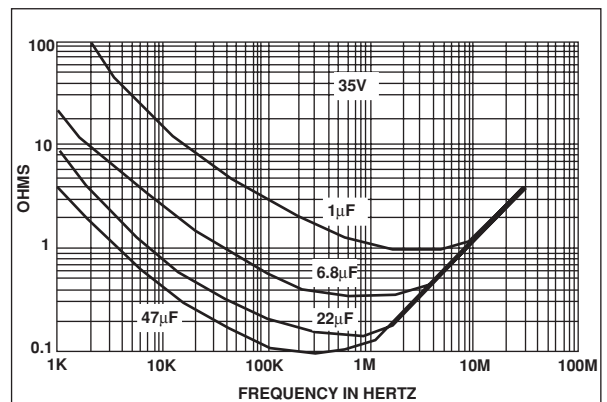
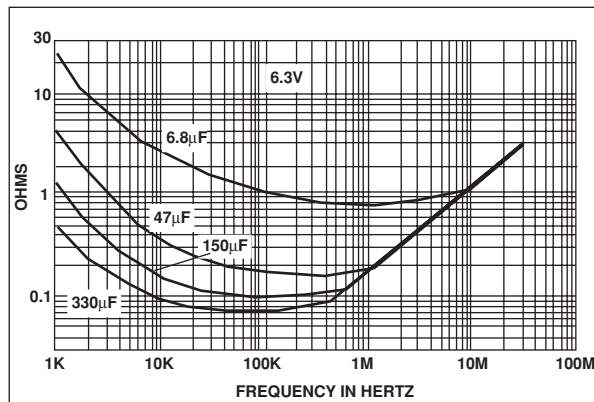

PERFORMANCE CHARACTERISTICS

- Operating Temperature:** - 55°C to + 85°C with rated voltage U_R applied. + 85°C to + 125°C with linear voltage derating to category voltage U_C (see general information) applied.
- Capacitance and Tolerance:** Capacitance measured at 100Hz and + 25°C shall be within the specified tolerance limits of the nominal rating.
- Reverse Voltage:** 15% of rated voltage at + 25°C
5% of rated voltage at + 85°C
- Surge Voltage:** 130% of U_R at + 85°C
130% of U_C at + 125°C.
- Impedance at 100 kHz:** Measured at + 20°C \pm 5°C, impedance shall not exceed the values listed in data sheet.
- Stability at low and high temperatures:** Capacitance change with temperature, dissipation factor and DC leakage current shall not exceed the limits of the following table.
- Charge and Discharge Test:** 1 million cycles at + 85°C,
0.5 s charge at U_R .
0.5 s discharge
Series resistance < 0.5 ohm

 $\Delta C/C \leq 5\%$ of initial value
 $I_L \leq$ initial limit
DF \leq initial limit
- Marking:**
Top: Rating and polarity
Front: Type, date code, SPRAGUE trademark

TEMP-ERATURE	CAPACITANCE CHANGE $C_R U_R \leq 1900$ $C_R U_R > 1900$	DISSIPATION FACTOR I_L	LEAKAGE CURRENT
- 55°C	- 10%	9% 11%	-
+ 25°C	-	6% 8%	0.01 $C_R \times U_R$ or 1 μ A whichever is greater
+ 85°C	+ 12%	9% 11%	0.1 $C_R \times U_R$ or 10 μ A whichever is greater
+ 125°C	+ 15%	12% 14%	0.125 $C_R \times U_R$ or 12.5 μ A whichever is greater

- Life Test:** 2000 hours at + 85°C with rated voltage applied
2000 hours at + 125°C. with category voltage applied.

$\Delta C/C \leq 10\%$ of initial value

$I_L \leq 1.25$ initial limit

DF \leq initial limit

- Humidity Test:** 56 days at + 40°C, 90% relative humidity

$\Delta C/C \leq 8\%$ of initial value

$I_L \leq$ initial limit

DF \leq initial limit

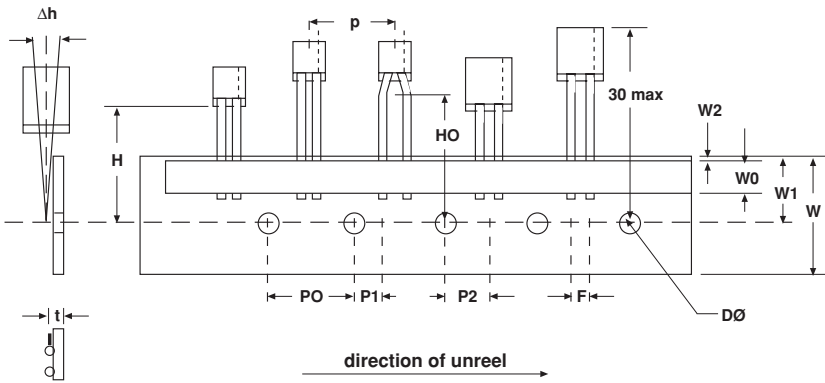
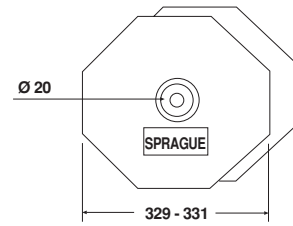
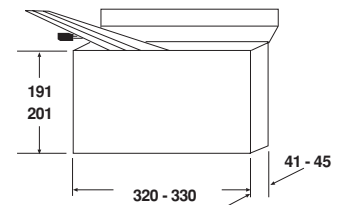
TAPE AND REEL PACKING
A and B Cases only (Meets IEC 286-2)

REEL PACKING

AMMOPACKING

CASE CODE	TAPE WIDTH	DIMENSIONS (mm) /UNITS PER REEL		
		Case A	Case B	Case B
Pitch of component	P [mm]	12.7 ± 1.0		
Feed hole pitch	P0 [mm]	12.7 ± 0.3		
Tape width	W [mm]	18 (+1 / - 0.5)		
Hold down tape width	W0 [mm]	5.0		
Hole position	W1 [mm]	9 (+0.75 / -0.5)		
Hold down tape position	W2 [mm]	0 (+3 /-0)		
Feed hole diameter	D0 [mm]	4.0 ± 0.3		
Tape thickness	T [mm]	0.5 ± 0.2		
Component alignment	Δh [mm]	0 ± 2		
Lead clinch height	H0 [mm]	16.0 ± 0.5		
Hole center to component center	P2 [mm]	6.35 ± 1.3		
Lead wire spacing	F[mm]	2.5 + 0.6, - 0.1	5 + 0.6, - 0.1	5 + 0.6, - 0.1
Feed hole center to wire center	P1 [mm]	5.1 ± 0.7	3.85 ± 0.7	3.85 ± 0.7
Reel pack options	H = 16.5 mm H = 18.5 mm	X Y	Z	X Y
Ammopack options	H = 16.5 mm H = 18.5 mm	G H	I	G H
Quantity per reel / box		1000	1000	1000