

### General Description

The AAT1270 is a high-efficiency, high-current boost converter capable of 1A maximum output current. It is an ideal power solution for LED photo flash applications in all single-cell Lithium-ion / polymer battery operated products.

The AAT1270 maintains output current regulation by switching the internal high-side and low-side switch transistors. The transistor switches are pulse-width modulated at a fixed frequency of 2MHz. The high switching frequency allows the use of a small inductor and output capacitor, making the AAT1270 ideally suited for small battery-powered applications.

AnalogicTech's proprietary S<sup>2</sup>Cwire™ (Simple Serial Control™) serial digital interface is used to enable, disable and set the movie mode current level for the flash LEDs to one of 16 levels. The AAT1270 also includes a separate Flash Enable input to initiate both flash/strobe operation and the default timer, which can be used to terminate a flash event after a user-programmed delay or as a safety feature. A Flash Inhibit pin is also included which reduces flash current to movie mode level during high battery demand.

The maximum flash and movie mode current is set by one external resistor; the ratio between flash and movie mode current is set at approximately 7.3:1. One or two LEDs can be connected to the AAT1270; when two LEDs are used, the output current is matched between each diode.

The AAT1270 contains over-voltage protection and a thermal management system to protect the device in the event of an output open-circuit and short-circuit condition respectively. Built-in circuitry prevents excessive inrush current during start-up. The shutdown feature reduces quiescent current to less than 1.0µA.

### Typical Application

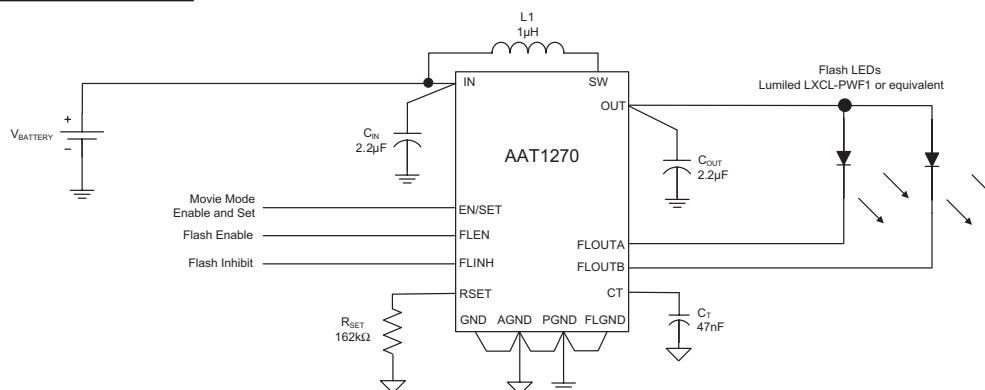

The AAT1270 is available in a Pb-free, thermally-enhanced 14-pin 3x3mm STDFN package.

### Features

- Input Voltage Range: 2.7V to 5.5V
- Dual Channel Output
  - Up to 1A Regulated Output Current (0.5A per Channel)
- Up to 85% Efficiency with Small Magnetics
- 2 MHz Switching Frequency
- Separate Flash Enable Input
- Separate Flash Inhibit Input
- Single Resistor Sets Flash and Movie Mode Current
  - Fixed Flash-to-Movie Mode Current Ratio
- 16-Level Movie Mode Current via S<sup>2</sup>Cwire™
- User-Programmable Safety Timer
- True Load Disconnect
- Input Current Limit
- Over-Voltage (Open LED, Open Circuit), Short-Circuit, and Over-Temperature Protection
- Shutdown Current: < 1.0µA
- Small Inductor Solution: 1µH (0.9mm in height)
- 14-pin STDFN 3x3 Package
- -40 to +85°C Temperature Range

### Applications

- Camcorder Video Light (Torch Light)
- Cellphones / Smartphones
- Digital Still Cameras (DSC)
- LED Photo Flash Light (Strobe Light)
- Mobile Handsets
- MP3 Players
- PDAs and Notebook PCs

### Pin Descriptions

Pin #	Symbol	Function
1	CT	Flash timer control input. Connect a capacitor between CT and AGND to set maximum duration for the flash pulse. A 47nF ceramic capacitor sets the flash timer to 1s. To disable the flash timer, connect CT to AGND.
2	EN/SET	Enable and movie mode serial control input. EN/SET is the S <sup>2</sup> Cwire programming input to adjust the movie mode current level to one of 16 different levels based on the maximum current/7.3 set via the RSET pin.
3	FLEN	Flash enable pin. A low-to-high transition on the FLEN pin initiates a flash pulse and starts the flash timer.
4	AGND	Analog ground pin. Connect AGND to PGND, GND, and FLGND at a single point as close to the AAT1270 as possible.
5	IN	Power input. Connect IN to the input power supply voltage. Connect a 2.2μF or larger ceramic capacitor from IN to PGND as close as possible to the AAT1270
6	SW	Boost converter switching node. Connect a 1μH inductor between SW and IN.
7	PGND	Power ground pin. Connect PGND to AGND, GND, and FLGND at a single point as close to the AAT1270 as possible.
8	OUT	Power output of the boost converter. Connect a 2.2μF or larger ceramic capacitor from OUT to PGND as close as possible to the AAT1270. Connect OUT to the anode(s) of the flash LED(s).
9	GND	Ground pin. Connect GND to PGND, AGND, and FLGND at a single point as close to the AAT1270 as possible.
10	FLINH	Flash inhibit pin. FLINH is an active HIGH control input with an internal 200kΩ resistor to AGND. A low-to-high transition on the FLINH pin reduces FLOUTA and FLOUTB output currents to the maximum (default) movie-mode current level for the duration of FLINH. Strobing the FLINH pin low to high does not reset the flash timer.
11	FLOUTB	Flash output B. Connect cathode of Flash LEDB to FLOUT B. For a single flash LED, connect FLOUTB and FLOUTA together. For two flash LEDs, each output will conduct 50% of the total flash output current.
12	FLGND	Flash ground pin. Connect FLGND to PGND, GND, and AGND at a single point as close to the AAT1270 as possible
13	FLOUTA	Flash output A. Connect cathode of Flash LED A to FLOUTA. For a single flash LED, connect FLOUTA and FLOUTB together. For two flash LEDs, each output will conduct 50% of the total flash output current.
14	RSET	Flash current setting input. A 162kΩ resistor from RSET to AGND sets the maximum flash current available at FLOUTA or FLOUTB to 500mA. Each FLOUTA and FLOUTB channel will conduct 50% of the maximum programmed current. The AAT1270's flash-to-movie-mode ratio is fixed at 7.3.
EP		Exposed paddle (bottom); Connect EP to PGND as close as possible to the AAT1270.

### Pin Configuration

**STDFN33-14**  
(Top View)

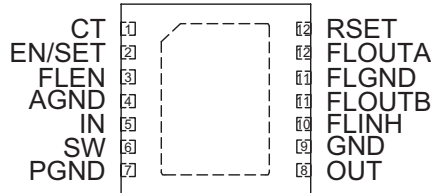

### Absolute Maximum Ratings<sup>1</sup>

$T_A = 25^\circ\text{C}$  unless otherwise noted.

Symbol	Description	Value	Units
IN, SW, OUT	Maximum Rating	-0.3 to 6.0	V
RSET, EN/SET, FLEN, FLINH, CT, FLOUTA, FLOUTB	Maximum Rating	$V_{IN} + 0.3$	V
$T_J$	Operating Temperature Range	-40 to 150	$^\circ\text{C}$
$T_S$	Storage Temperature Range	-65 to 150	$^\circ\text{C}$
$T_{LEAD}$	Maximum Soldering Temperature (at leads, 10 sec)	300	$^\circ\text{C}$

### Recommended Operating Conditions

Symbol	Description	Value	Units
$\theta_{JA}$	Thermal Resistance	50	$^\circ\text{C}/\text{W}$
$P_D$	Maximum Power Dissipation	2	W

1. Stresses above those listed in Absolute Maximum Ratings may cause permanent damage to the device. Functional operation at conditions other than the operating conditions specified is not implied. Only one Absolute Maximum Rating should be applied at any one time.

### Electrical Characteristics<sup>1</sup>

$V_{IN} = 3.6V$ ;  $C_{IN} = 2.2\mu F$ ;  $C_{OUT} = 2.2\mu F$ ;  $R_{SET} = 162k\Omega$ ;  $T_A = 0^\circ C$  to  $70^\circ C$ , unless otherwise noted. Typical values are  $T_A = 25^\circ C$ .

Symbol	Description	Conditions	Min	Typ	Max	Units
<b>Power Supply</b>						
$V_{IN}$	Input Voltage Range		2.7		5.5	V
$V_{OUT(MAX)}$	Maximum Output Voltage				5.5	V
$I_{IN(Q)}$	$V_{IN}$ Supply Current	FLEN = IN, Set FL Load = 1A		0.57	1	mA
		EN/SET = IN, Set FL Load = 0A, $R_{SET} = 162k\Omega$		0.23		
$I_{SHDN(MAX)}$	$V_{IN}$ Shutdown Current	EN/SET = FLEN = FLINH = GND			1	$\mu A$
$I_{FL(TOTAL)}$	Total Output Current, Flash Mode	$R_{SET} = 162k\Omega$ ; FLOUTA + FLOUTB	800	1000	1200	mA
$I_{FL(MATCH)}$	FLOUTA and FLOUTB Current Matching			10		%
$I_{MM(TOTAL)}$	Total Output Current, Movie Mode	$R_{SET} = 162k\Omega$ ; Movie Mode Current Set = 100%; FLOUTA + FLOUTB		137		mA
$f_{OSC}$	Switching Frequency	$T_A = 25^\circ C$	1.5	2.0	2.5	MHz
$t_{DEFAULT}$	Default ON time	$C_T = 47nF$		1		s
$T_{SD}$	Thermal Shutdown Threshold			140		$^\circ C$
$T_{SD(HYS)}$	Thermal Shutdown Hysteresis			15		$^\circ C$
<b>EN/SET/ FLEN/ FLINH Logic Control</b>						
$V_{EN/SET(L)}$ , $V_{FLEN(L)}$	EN/SET, FLEN Input Low Threshold				0.4	V
$V_{EN/SET(H)}$ , $V_{FLEN(H)}$	EN/SET, FLEN Input High Threshold		1.4			V
$I_{EN/SET}$	EN/SET Input Leakage Current	$V_{EN/SET} = V_{IN} = 5V$	-1		1	$\mu A$
$I_{FLEN}$	FLEN Input Leakage Current	$V_{FLEN} = V_{IN} = 5V$	-1		1	$\mu A$
$V_{T(FLINH)}$	FLINH Input Threshold Voltage			$\frac{1}{2} V_{IN}$		V
$R_{IN(FLINH)}$	FLINH Input Resistance to AGND			200		k $\Omega$
$t_{EN/SET(LOW)}$	EN/SET Serial Interface Low Time		0.3		75	$\mu s$
$t_{EN/SET(HI-MIN)}$	Minimum EN/SET High Time			50		ns
$t_{EN/SET(HI-MAX)}$	Maximum EN/SET High Time				75	$\mu s$
$t_{EN/SET(OFF)}$	EN/SET Off Timeout				500	$\mu s$
$t_{EN/SET(LAT)}$	EN/SET Latch Timeout				500	$\mu s$
$t_{FLEN\_ON}$	FLEN ON Delay Time	EN/SET = GND		100		$\mu s$
$t_{FLEN\_OFF}$	FLEN OFF Delay Time	EN/SET = GND		20		$\mu s$
$t_{FLINH\_ON}$	FLINH ON Delay Time			100		$\mu s$
$t_{FLINH\_OFF}$	FLINH OFF Delay Time			5		$\mu s$

1. The AAT1270 is guaranteed to meet performance specification from  $0^\circ C$  to  $+70^\circ C$ . Specification over the  $-40^\circ C$  to  $+85^\circ C$  operating temperature range is assured by design, characterization and correlation with statistical process controls.

### Typical Characteristics

**Efficiency vs. Input Voltage**  
(Movie and Flash Mode)

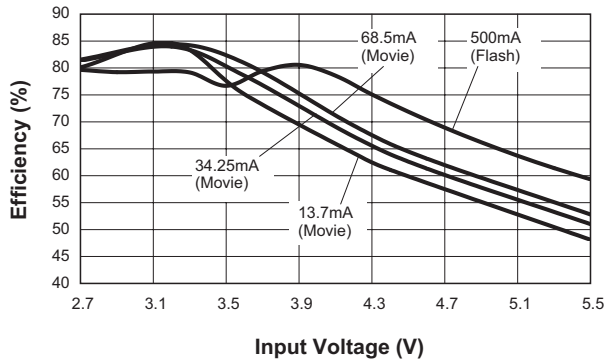

**Shutdown Current vs. Input Voltage**  
(EN/SET = FLEN = 0V)

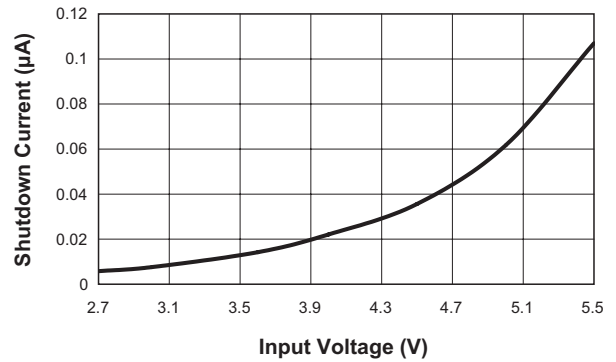

**Switching Frequency vs. Input Voltage**  
(EN/SET = FLEN = 0V)

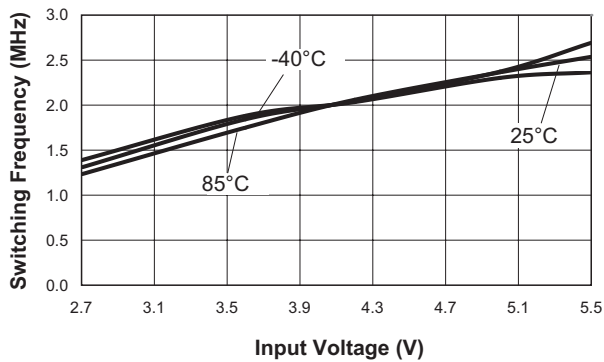

**Movie Mode LED Current Accuracy vs. Input Voltage**  
(68.5mA/Ch)

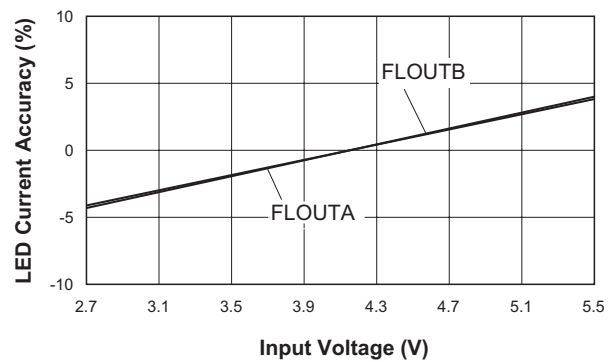

**Movie Mode Current Matching vs. Temperature**  
(68.5mA/ch)

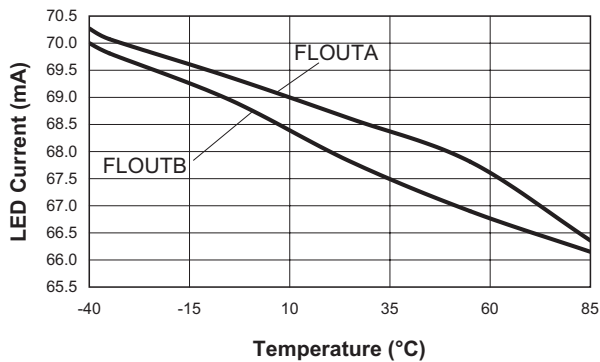

**Flash Mode Current Matching vs. Temperature**  
(500mA/ch)

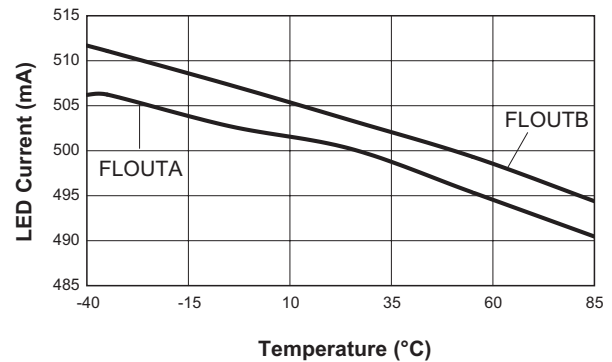

**Typical Characteristics**

**Flash Mode Output Ripple**  
(500mA/ch)

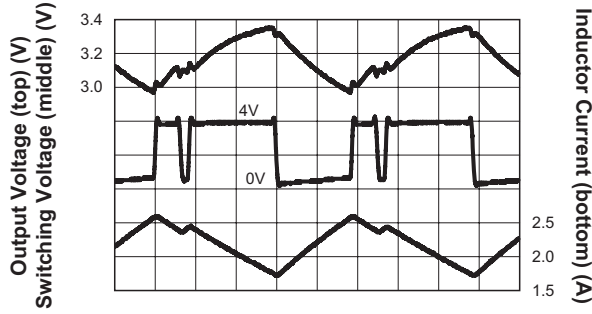

Time (250ns/div)

**Movie Mode Output Ripple**  
(68.5mA/ch)

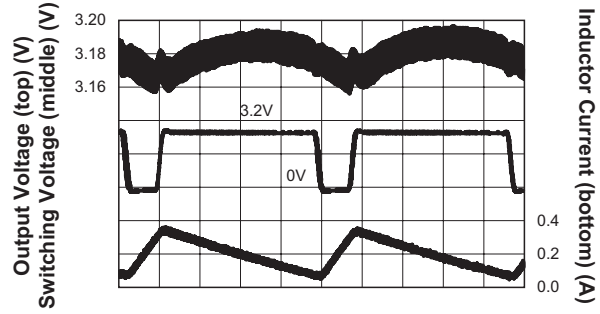

Time (125ns/div)

**EN/SET, FLEN Input High Threshold vs. Input Voltage**

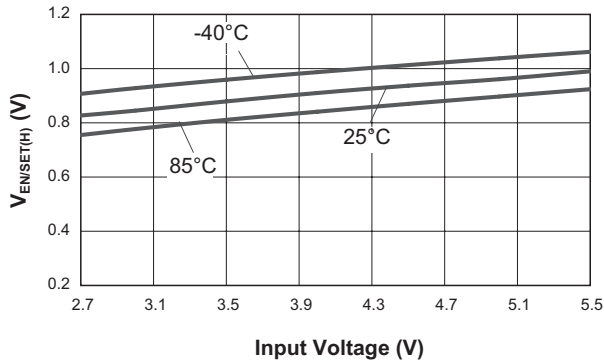

**EN/SET, FLEN Input Low Threshold vs. Input Voltage**

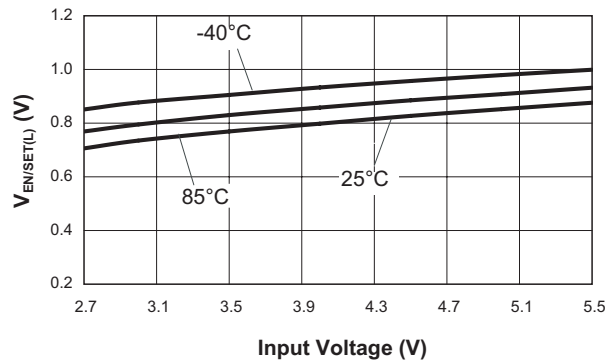

**EN/SET Latch Timeout vs. Input Voltage**

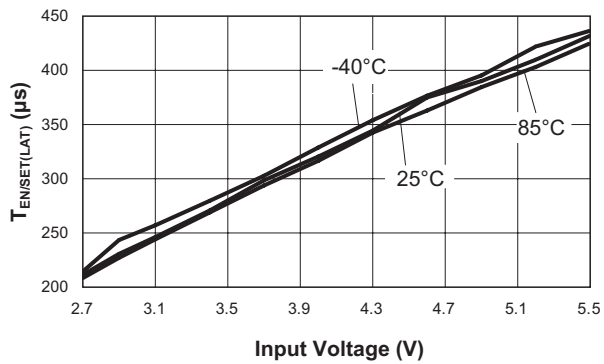

**EN/SET Off Timeout vs. Input Voltage**

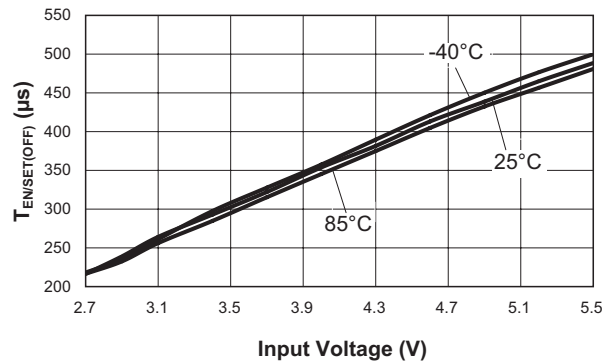

### Typical Characteristics

**FLEN ON Delay Time vs. Input Voltage**

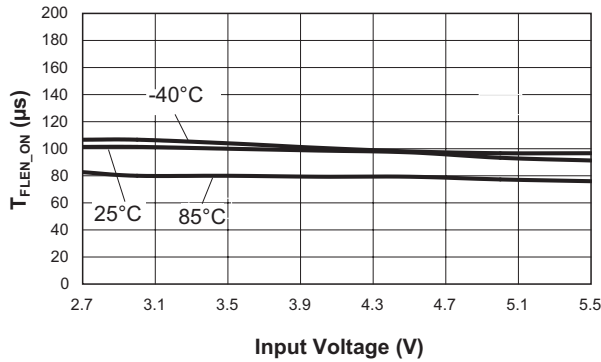

**Flash Inhibit On Delay Time**  
(EN/SET = 0V; FLEN = 3.3V; 500mA/ch)

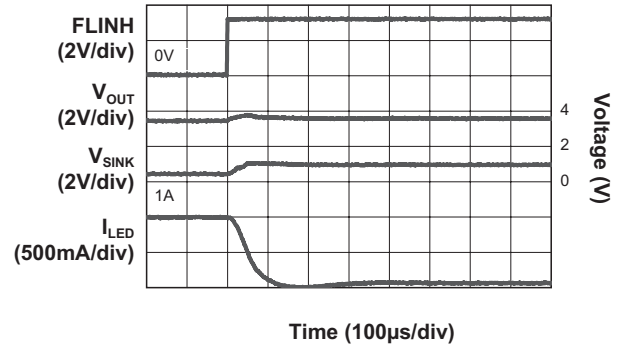

**Movie Mode Turn On**  
(13.7mA/ch)

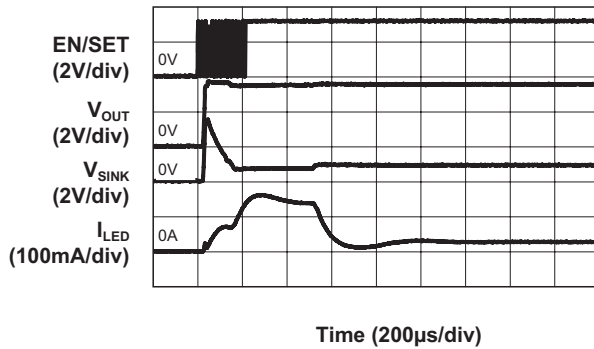

**Movie Mode Turn On**  
(68.5mA/ch)

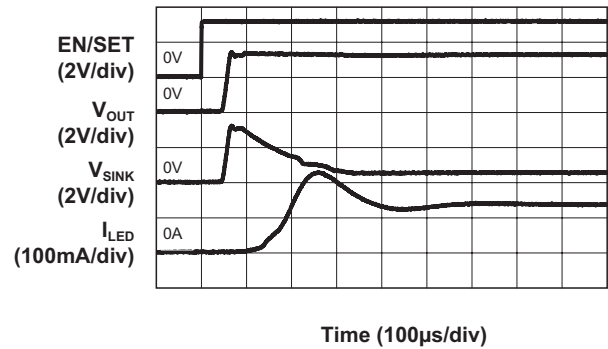

**Movie Mode to Flash Mode Turn On**  
(68.5mA/ch to 500mA/ch)

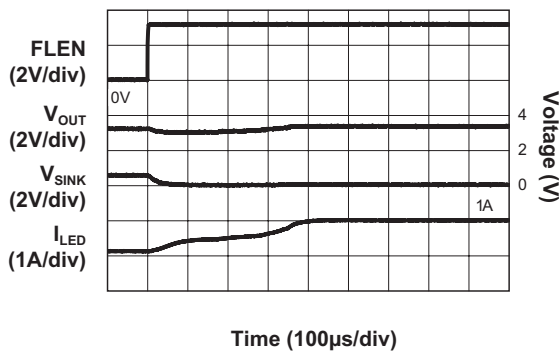

**Flash Mode Turn On**  
(500mA/ch)

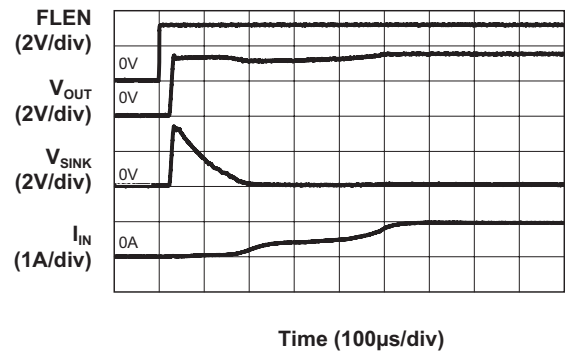

### Typical Characteristics

**Movie Mode Line Transient**  
(68.5mA/ch;  $V_{IN} = 4.2V$  to  $3.6V$ )

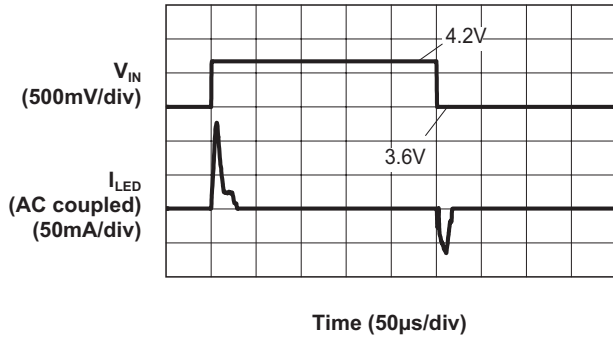

**Movie Mode Current Transition**  
(68.5mA/ch to 13.7mA/ch)

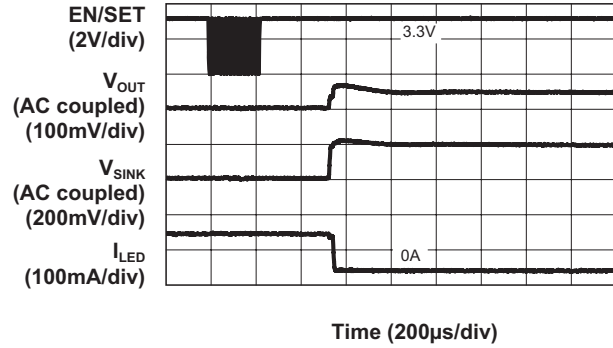



### Functional Block Diagram

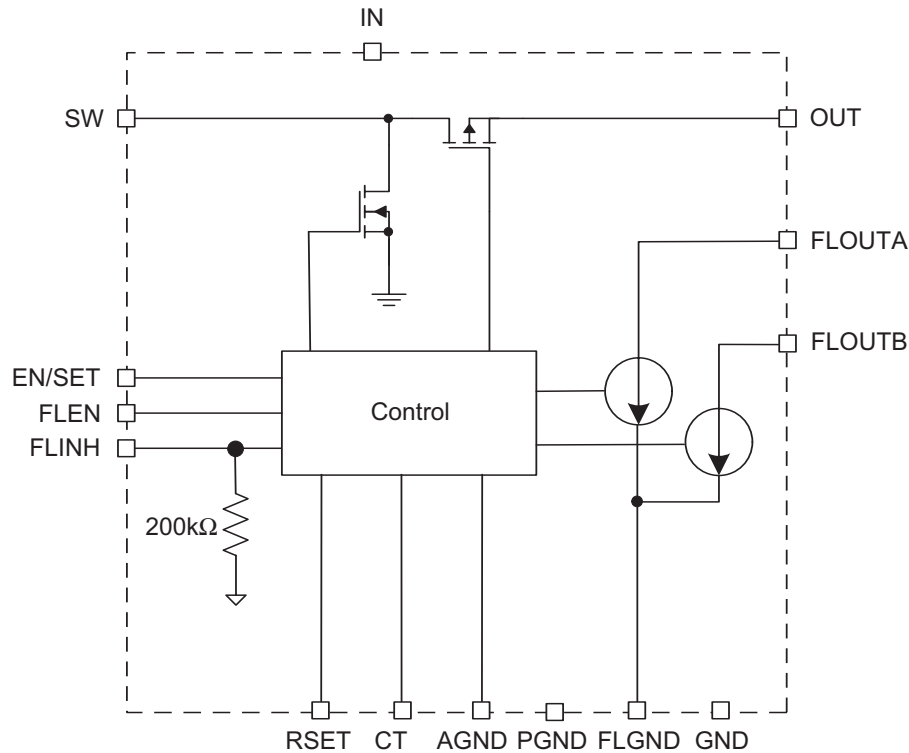

### Functional Description

The AAT1270 is a boost converter with a current regulated output designed to drive high current white LEDs used in flash/movie light applications. The maximum flash current is set by an external resistor,  $R_{SET}$ , which not only sets the flash current but also sets the maximum movie mode current reduced by a factor of 7.3. A flash pulse is initiated by switching the FLEN (flash enable) pin from low to high, which initiates the flash pulse and also starts the internal timer. The maximum flash time is determined by an external timing capacitor connected to the CT pin. The flash duration can be set from 50ms

to a maximum of 1s. The flash timer will terminate the flash current regardless of the status of the FLEN pin. This can be either used as a simple flash timing pulse or as a safety timer in the event of a control logic malfunction to prevent the LED from over-heating. If the safety timer is not needed in the application, it can be disabled by connecting the CT pin directly to AGND.

For applications using two flash LEDs, each diode can be connected to its corresponding current sink (FLOUTA or FLOUTB) and the output current will be equally shared. In single flash LED applications, the two current sinks can be connected together to apply the full output current into the LED.

If one sink pin (FLOUTA or FLOUTB) is not used, the unused current sink must be directly connected to OUT, which disables that channel.

The movie-mode output current is controlled by the EN/SET pin, which uses a single-wire S<sup>2</sup>Cwire interface to adjust the output current to one of 16 different levels. As shown in Table 1, the current settings are in logarithmic scale where each code is 1dB below the previous code. The FLEN signal takes priority over movie-mode operation.

In mobile GSM systems where the phone remains in constant contact with the base station by regular communication, a FLINH pin is provided to prevent the camera flash and PA transmission pulses from occurring simultaneously, potentially causing the battery voltage to drop below the system's undervoltage lockout threshold (UVLO) or creating unwanted EMI.

During a flash event, strobing the FLINH pin low-to-high will reduce the LED current to the maximum movie mode current level for the duration of FLINH. Strobing FLINH high-to-low will instruct the AAT1270 to revert the flash LED current to its default (maximum) level assuming that the FLEN pin is still active (HIGH) and that the flash timer has not expired.

### Over-Temperature Protection

Thermal protection disables the AAT1270 when internal power dissipation becomes excessive, as it disables both MOSFETs. The junction over-temperature threshold is 140°C with 15°C of temperature hysteresis. The output voltage automatically recovers when the over-temperature fault condition is removed.

### Over-Voltage Protection (Open LED, Open Circuit)

The AAT1270's output voltage is limited by internal over-voltage protection circuitry, which prevents damage to the AAT1270 from open LED or open circuit conditions.

During an open circuit, the output voltage rises and reaches 5.5V (typical), and the OVP circuit disables the switching, preventing the output voltage from rising higher. Once the open circuit condition is removed, switching will resume. The controller will return to normal operation and maintain an average output voltage.

## Applications Information

### LED Selection

The AAT1270 is specifically designed to drive white flash LEDs (typical forward voltage of 2.5V to 4.5V). Since the FLOUTA and FLOUTB input current sinks are matched with low voltage dependence; the LED-to-LED brightness will be matched regardless of the individual LED forward voltage ( $V_F$ ) levels.

### Flash Mode LED Current

The LED current is controlled by the  $R_{SET}$  resistor. For maximum accuracy, a 1% tolerance resistor is recommended. FLOUTA and FLOUTB can be programmed up to a maximum total flash current of 1A, or up to 500mA per channel. FLOUTA and FLOUTB output current is matched across the programming range.

The maximum flash current in each FLOUTA and FLOUTB is set by the  $R_{SET}$  resistor and can be calculated using the following equation:

$$I_{FLOUTA} = I_{FLOUTB} = \frac{81k\Omega \cdot A}{R_{SET}} = \frac{81k\Omega \cdot A}{162k\Omega} = 500mA \text{ per channel}$$

### Movie Mode LED Current

In the default movie mode, the corresponding FLOUTA/FLOUTB movie mode current can be calculated:

$$I_{MOVIE\ MODE[A/B]} = \frac{I_{FLOUTA/BIMAX}}{7.3}$$

For example, if an  $R_{SET}$  value of 162k $\Omega$  is chosen, then the FLOUTA/FLOUTB flash current is set to 500mA. For movie mode operation, the maximum current available at either FLOUTA or FLOUTB is then:

$$I_{MOVIE\ MODE[A/B]} = \frac{I_{FLOUTA/BIMAX}}{7.3} = \frac{500mA}{7.3} = 68.5mA$$

Alternatively, the AAT1270 S<sup>2</sup>Cwire interface programs the movie mode current at a reduced level. The FLOUTA/FLOUTB movie-mode current can be adjusted in logarithmic fashion to one of 16 steps. Table 1 illustrates approximate movie mode levels

to which the AAT1270 movie mode operation can be programmed.

S <sup>2</sup> Cwire Data	Percentage of Maximum Movie Mode Current (%)
1	100
2	89
3	79
4	71
5	63
6	56
7	50
8	44.7
9	39.8
10	35.5
11	31.6
12	28.2
13	25.1
14	22.4
15	20
16	0

**Table 1: Programming Movie Mode Current via S<sup>2</sup>Cwire (%).**

### S<sup>2</sup>Cwire Serial Interface

The Simple Serial Control (S<sup>2</sup>Cwire) serial interface records rising edges at the EN/SET pin and decodes them into 16 different states. The S<sup>2</sup>Cwire serial interface has flexible timing. Data can be applied at speeds faster than 1MHz, or at much slower speeds, such as 15kHz. After data is applied, EN/SET is strobed high and held high to latch the data.

Once the signal applied at the EN/SET pin has been held in the logic high state for time longer than  $t_{LAT}$  (500 $\mu$ s), the programmed current becomes active and the internal data register is reset to zero. For subsequent current level programming, the number of rising edges corresponding to the desired code must be applied to the EN/SET pin.

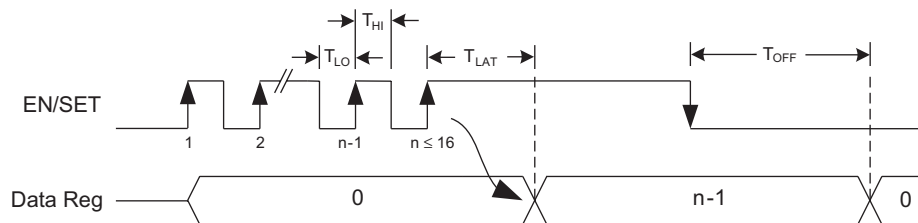

**Figure 1: S<sup>2</sup>Cwire Serial Interface Timing**

**Flash Timer**

The AAT1270A includes a timer circuit that enables the flash current sinks for a programmed period of time. This feature eliminates the need for an external, housekeeping baseband controller to contain a safety delay routine. It also serves as a protection feature to minimize thermal issues with the flash LEDs in the event an external controller’s flash software routine experiences hang-up or freeze.

The flash timeout T can be calculated by the following equation:

$$T = 21.5s/\mu F \cdot C_T$$

Where T is in seconds and  $C_T$  is the capacitance of the timer capacitor in  $\mu F$ .

For example, using a 47nF capacitor for  $C_T$  sets the flash timeout to:

$$\text{Flash Timeout} = 21.5s/\mu F \cdot 0.047\mu F = 1s$$

The relationship between capacitance of the timer capacitor and the flash timeout is illustrated in Figure 2.

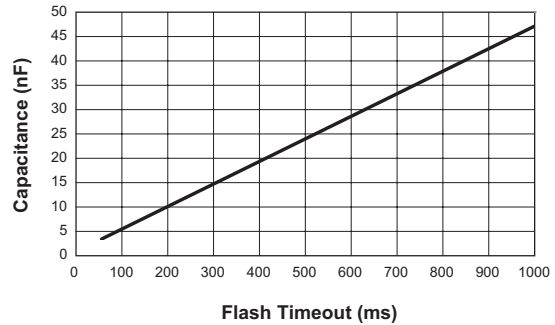

**Figure 2: Timer Capacitor vs. Flash Timeout.**

**Timing Diagram**

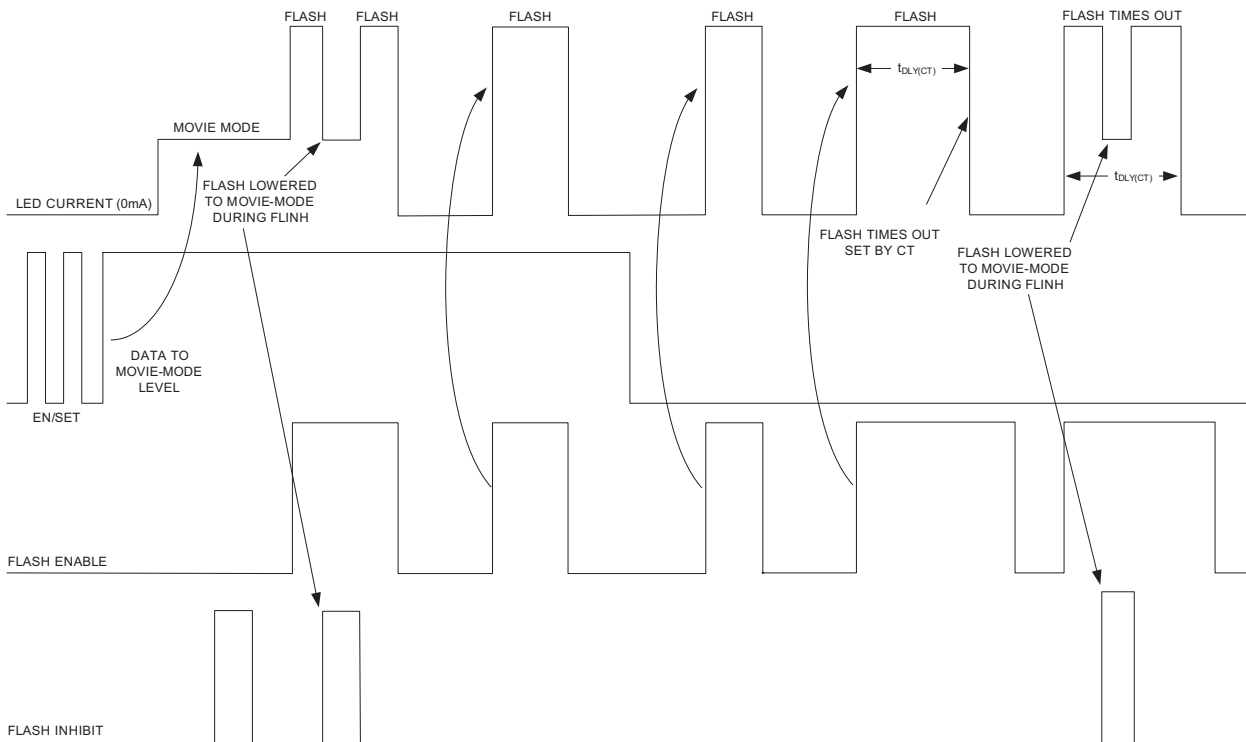

### Selecting the Boost Inductor

The AAT1270 controller utilizes PWM control and the switching frequency is fixed. To maintain 2MHz maximum switching frequency and stable operation, a 1µH output inductor is recommended.

Manufacturer's specifications list both the inductor DC current rating, which is a thermal limitation, and peak inductor current rating, which is determined by the saturation characteristics. Measurements at full load and high ambient temperature should be performed to ensure that the inductor does not saturate or exhibit excessive temperature rise.

The output inductor (L) is selected to avoid saturation at minimum input voltage and maximum output load conditions. Worst-case peak current occurs at minimum input voltage (maximum duty cycle) and maximum load.

At high load the switching frequency is somewhat diminished, resulting in higher  $I_{PEAK}$ . Bench measurements are recommended to confirm actual  $I_{PEAK}$  and to ensure that the inductor does not saturate at maximum LED current and minimum input supply voltage.

The RMS current flowing through the boost inductor is equal to the DC plus AC ripple components. Under worst-case RMS conditions, the current waveform is critically continuous. The resulting RMS calculation yields worst-case inductor loss. The RMS current value should be compared against the inductor manufacturer's temperature rise, or thermal derating, guidelines:

$$I_{RMS} = \frac{I_{PEAK}}{\sqrt{3}}$$

For a given inductor type, smaller inductor size leads to an increase in DCR winding resistance and, in most cases, increased thermal impedance. Winding resistance degrades boost converter efficiency and increases the inductor's operating temperature:

$$P_{LOSS(INDUCTOR)} = I_{RMS}^2 \cdot DCR$$

### Selecting the Boost Capacitors

In general, it is good design practice to place a decoupling capacitor (input capacitor) between the IN and GND pins. An input capacitor in the range of 2.2µF to 10µF is recommended. A larger input capacitor in this application may be required for stability, transient response, and/or ripple performance.

The high output ripple inherent in the boost converter necessitates the use of low impedance output filtering. Multi-layer ceramic (MLC) capacitors provide small size and adequate capacitance, low parasitic equivalent series resistance (ESR) and equivalent series inductance (ESL), and are well suited for use with the AAT1270 boost regulator. MLC capacitors of type X7R or X5R are recommended to ensure good capacitance stability over the full operating temperature range.

Manufacturer	Part Number	Inductance (µH)	Max DC $I_{SAT}$ Current (A)	DCR (mΩ)	Size (mm) (LxWxH)	Type
Murata	LQM2HPN1R0MG0	1.0	1.6	55	2.5x2.0x0.9	Multilayer
Murata	LQH3NPN1R0G0	1.0	1.58	110	3.0x3.0x1.0	Wirewound
CoilCraft	LPS3010	1.0	1.6	85	3.0x3.0x1.0	Wirewound
Cooper Bussmann	SD3110	1.0	1.47	68.3	3.1x3.1x1.0	Wirewound
Cooper Bussmann	SD3812	1.0	3.89	30	4.0x4.0x1.2	Wirewound
Sumida	CDH38D11/S	1.0	2.8	39	4.0x4.0x1.2	Wirewound

**Table 2: Typical Suggested Surface Mount Inductors**

The output capacitor is selected to maintain the output load without significant voltage droop ( $\Delta V_{OUT}$ ) during the power switch ON interval. A ceramic output capacitor 2.2 $\mu$ F is recommended (see Table 3).

Typically, 6.3V or 10V rated capacitors are required for this flash LED boost output. Ceramic capacitors selected as small as 0603 are available which meet these requirements. MLC capacitors exhibit significant capacitance reduction with applied voltage. Output ripple measurements should confirm that output voltage droop and operating stability are with-

in acceptable limits. Voltage derating can minimize this factor, but results may vary with package size and among specific manufacturers.

To maintain stable operation at full load, the output capacitor should be selected to maintain  $\Delta V_{OUT}$  between 100mV and 200mV. The boost converter input current flows during both ON and OFF switching intervals. The input ripple current is less than the output ripple and, as a result, less input capacitance is required.

Manufacturer	Part Number	Capacitance ( $\mu$ F)	Voltage Rating (V)	Temp Co.	Case Size
Murata	GRM185R60J225KE26	2.2	6.3	X5R	0603
Murata	GRM188R71A225KE15	2.2	10	X7R	0603
Murata	GRM21BR70J225KA01	2.2	6.3	X7R	0805
Murata	GRM21BR71A225KA01	2.2	10	X7R	0805
Murata	GRM219R61A475KE19	4.7	10	X5R	0805
Murata	GRM21BR71A106KE51	10	10	X7R	0805

**Table 3: Typical Suggested Surface Mount Capacitors.**

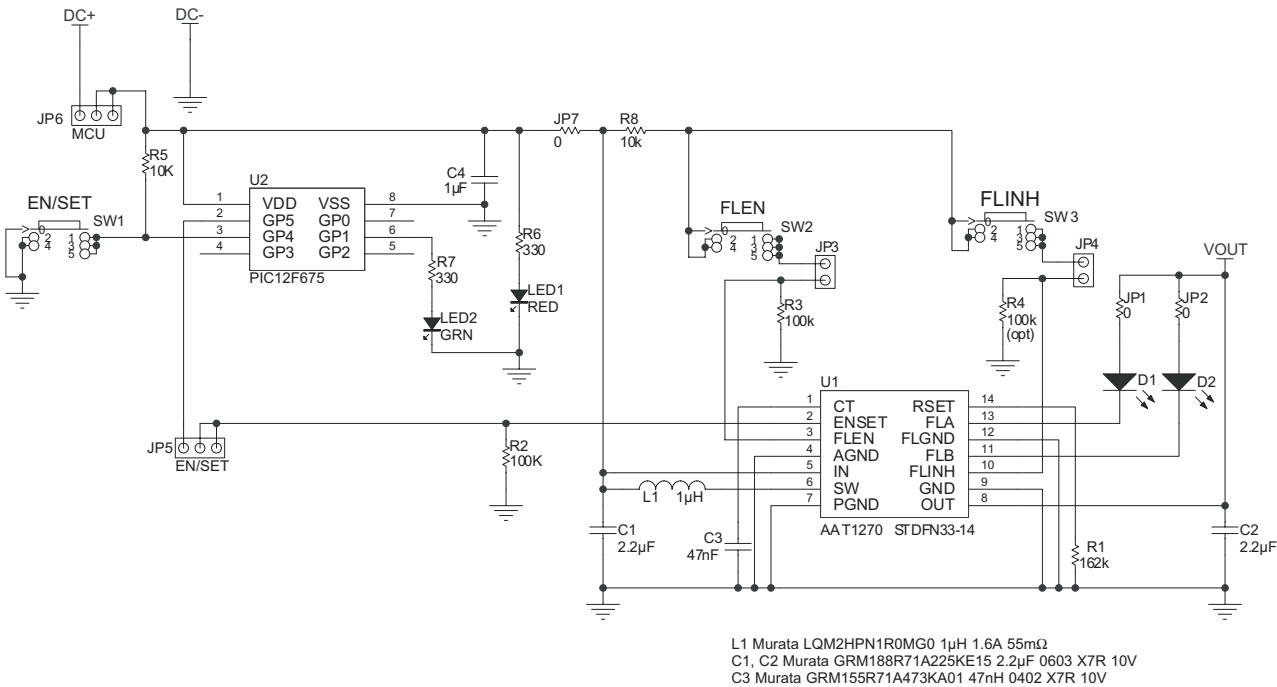

**Figure 3: AAT1270 Evaluation Board Schematic.**

## PCB Layout Guidelines

Boost converter performance can be adversely affected by poor layout. Possible impact includes high input and output voltage ripple, poor EMI performance, and reduced operating efficiency. Every attempt should be made to optimize the layout in order to minimize parasitic PCB effects (stray resistance, capacitance, and inductance) and EMI coupling from the high frequency SW node. A suggested PCB layout for the AAT1270 1A step-up regulator is shown in Figures 4 through 7. The following PCB layout guidelines should be considered:

1. Minimize the distance from capacitor  $C_{IN}$  and  $C_{OUT}$ 's negative terminals to the PGND pins. This is especially true with output capacitor

2. Minimize the distance between L1 to IN and switching pin SW; minimize the size of the PCB area connected to the SW pin.
3. Maintain a ground plane and connect to the IC PGND pin(s) as well as the PGND connections of  $C_{IN}$  and  $C_{OUT}$ .
4. Consider additional PCB exposed area for the flash LEDs to maximize heatsinking capability. This may be necessary when using high current application and long flash duration application.
5. Connect the exposed paddle (bottom of the die) to either PGND or GND. Connect AGND, FLGND to GND as close as possible to the package.

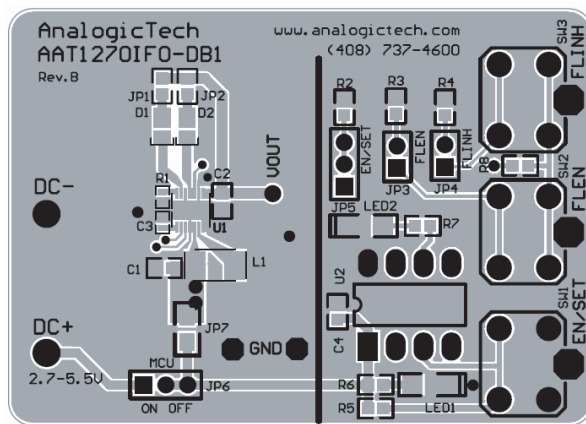

Figure 4: AAT1270 Evaluation Board Top Side Layout.

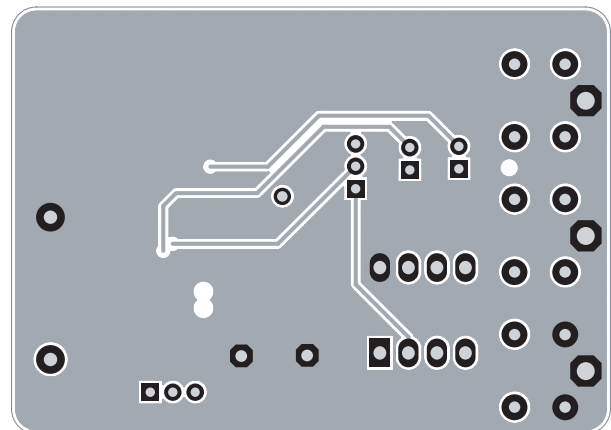

Figure 5: AAT1270 Evaluation Board Second Layer.

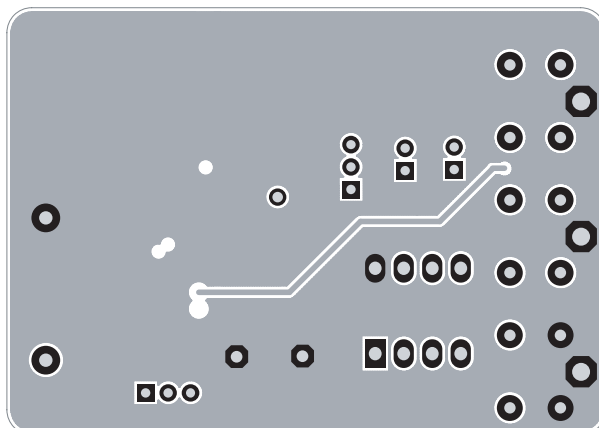

Figure 6: AAT1270 Evaluation Board Third Layer.

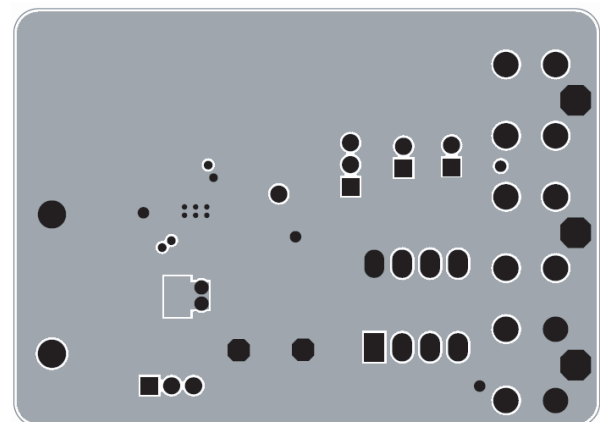

Figure 7: AAT1270 Evaluation Board Bottom Side Layout.

Component	Part Number	Description	Manufacturer
U1	AAT1270IFO	1A Step-Up Current Regulator for Flash LEDs; STDFN33-14 package	AnalogicTech
U2	PIC12F675	8-bit CMOS, FLASH-based $\mu$ C; 8-pin PDIP package	Microchip
SW1-SW3	PTS645TL50	Switch Tact, SPST, 5mm	ITT Industries
R1	Chip Resistor	162k $\Omega$ , 1%, 1/4W; 0402	Vishay
R2, R3, R4	Chip Resistor	100k $\Omega$ , 1%, 1/4W; 0603	Vishay
R5, R8	Chip Resistor	10k $\Omega$ , 5%, 1/4W; 0603	Vishay
R6, R7	Chip Resistor	330 $\Omega$ , 5%, 1/4W; 0603	Vishay
JP1, JP2, JP7	Chip Resistor	0 $\Omega$ , 5%	Vishay
C1, C2	GRM188R71A225KE15	2.2 $\mu$ F, 10V, X7R, 0603	Murata
C3	GRM155R71A473KA01	47nF, 10V, X7R, 0402	Murata
C4	GRM216R61A105KA01	1 $\mu$ F, 10V, X5R, 0805	Murata
L1	LQM2HPN1R0MG0	Multilayer, 1 $\mu$ H, 1.6A, 55m $\Omega$	Murata
D1-D2	LXCL-PWF1	White Flash LED	Lumileds, Philips
LED1	CMD15-21SRC/TR8	Red LED; 1206	Chicago Miniature Lamp
LED2	CMD15-21VGC/TR8	Green LED; 1206	Chicago Miniature Lamp
JP3, JP4, JP5, JP6	PRPN401PAEN	Conn. Header, 2mm zip	Sullins Electronics

**Table 4: AAT1270 Evaluation Board Bill of Materials.**



### Ordering Information

Package	Marking <sup>1</sup>	Part Number (Tape and Reel) <sup>2</sup>
STDFN33-14	XXYY	AAT1270IFO-T1



All AnalogicTech products are offered in Pb-free packaging. The term “Pb-free” means semiconductor products that are in compliance with current RoHS standards, including the requirement that lead not exceed 0.1% by weight in homogeneous materials. For more information, please visit our website at <http://www.analogictech.com/pbfree>.

### Package Information<sup>3</sup>

#### STDFN33-14

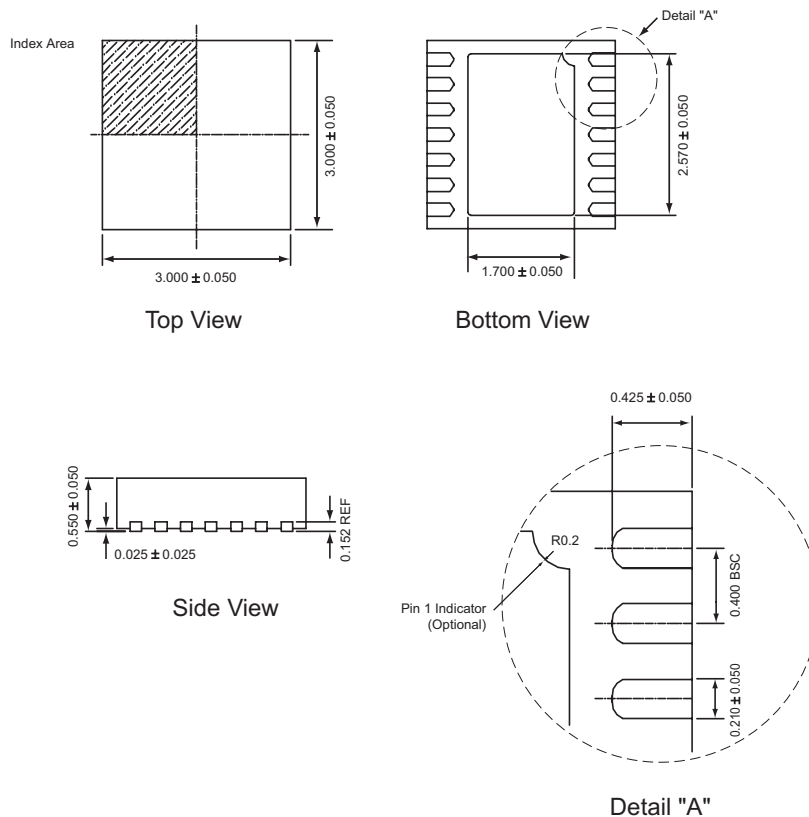

All dimensions in millimeters.

1. XYY = assembly and date code.
2. Sample stock is generally held on part numbers listed in **BOLD**.
3. The leadless package family, which includes QFN, TQFN, DFN, TDFN, and STDFN, has exposed copper (unplated) at the end of the lead terminals due to the manufacturing process. A solder fillet at the exposed copper edge cannot be guaranteed and is not required to ensure a proper bottom solder connection.

© Advanced Analogic Technologies, Inc.

AnalogicTech cannot assume responsibility for use of any circuitry other than circuitry entirely embodied in an AnalogicTech product. No circuit patent licenses, copyrights, mask work rights, or other intellectual property rights are implied. AnalogicTech reserves the right to make changes to their products or specifications or to discontinue any product or service without notice. Except as provided in AnalogicTech's terms and conditions of sale, AnalogicTech assumes no liability whatsoever, and AnalogicTech disclaims any express or implied warranty relating to the sale and/or use of AnalogicTech products including liability or warranties relating to fitness for a particular purpose, merchantability, or infringement of any patent, copyright or other intellectual property right. In order to minimize risks associated with the customer's applications, adequate design and operating safeguards must be provided by the customer to minimize inherent or procedural hazards. Testing and other quality control techniques are utilized to the extent AnalogicTech deems necessary to support this warranty. Specific testing of all parameters of each device is not necessarily performed. AnalogicTech and the AnalogicTech logo are trademarks of Advanced Analogic Technologies Incorporated. All other brand and product names appearing in this document are registered trademarks or trademarks of their respective holders.

**Advanced Analogic Technologies, Inc.**  
830 E. Arques Avenue, Sunnyvale, CA 94085  
Phone (408) 737-4600  
Fax (408) 737-4611

