

FEATURES

Integrated Front End for Single Pair or Two Pair HDSL Systems

Meets ETSI Specifications

Supports 1168 Kbps and 2.32 Mbps

Transmit and Receive Signal Path Functions

Receive Hybrid Amplifier, PGA and ADC

Transmit DAC, Filter and Differential Outputs

Programmable Filters

Control and Ancillary Functions

Timing Recovery DAC

Normal Loopback and Low Power Modes

Simple Interface-to-Digital Transceivers

Single 5 V Power Supply

Power Consumption: 320 mW—(Excluding Driver)

Package: 80-Lead MQFP

Operating Temperature: -40°C to +85°C

GENERAL DESCRIPTION

The AD6472 is a single chip analog front end for two pair or single pair HDSL applications that use 1168 Kbps or 2.32 Mbps data rates.

The AD6472 integrates all the transmit and receive functional blocks together with the timing recovery DAC.

The digital interface is designed to support industry standard digital transceivers.

While providing the full analog front end for ETSI standards (two pair or single pair HDSL applications) the AD6472 supports other applications because the architecture allows for bypassing the functional blocks.

The normal, low power, and loopback modes and the digital interface combine to make the AD6472 simple to integrate into systems.

FUNCTIONAL BLOCK DIAGRAM

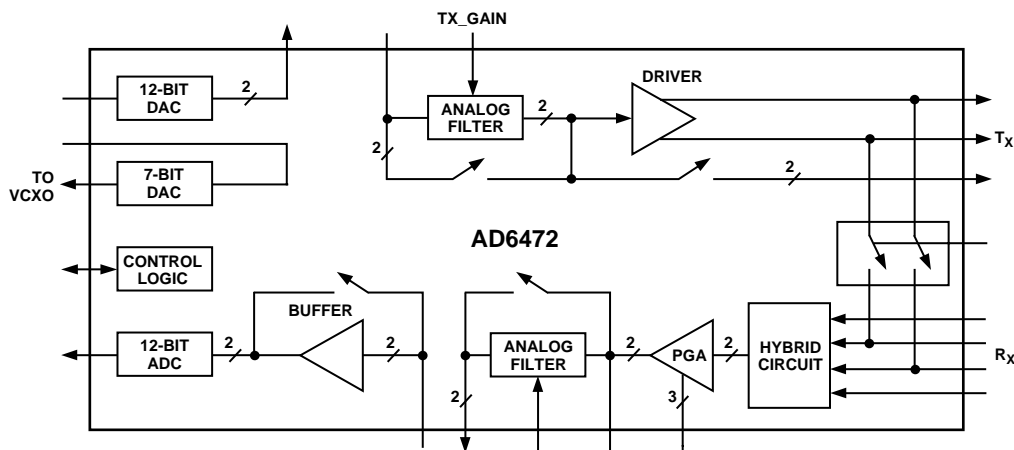

REV. 0

Information furnished by Analog Devices is believed to be accurate and reliable. However, no responsibility is assumed by Analog Devices for its use, nor for any infringements of patents or other rights of third parties which may result from its use. No license is granted by implication or otherwise under any patent or patent rights of Analog Devices.

AD6472–SPECIFICATIONS ($T_A = T_{MIN}$ to T_{MAX} unless otherwise noted)

| Parameter | Min | Typ | Max | Units | Condition |
|---------------------------------------|----------------|-------|--------|------------|---|
| TRANSMIT CHANNEL | | | | | |
| SNR | 68 | 71 | | dB | The complete transmit path spectrum and pulse shape comply with ETSI requirements. |
| THD | 66 | 71 | | dB | |
| TRANSMIT DAC | | | | | The transmit DAC maximum update rate is half the maximum output data rate, i.e., 1168 kHz. The maximum transmit clock is $16 \times 1168 = 18.688$ MHz. |
| Clock Frequency | | | 18.688 | MHz | |
| Resolution | | 12 | | Bits | |
| Update Rate | | | 1168 | kHz | |
| Output Voltage | | 2 | | V p-p Diff | |
| TRANSMIT FILTER | | | | | MODE_SEL1 = 0 MODE_SEL1 = 1 |
| Corner Frequency (3 dB) ¹ | | 320 | | kHz | |
| | | 535 | | kHz | |
| Accuracy | | ±5 | ±10 | % | |
| Gain | | 9.53 | | dB | |
| | | 3.53 | | dB | |
| LINE DRIVER | | | | | Transformer Turns Ratio = 1:2.3 at 50 kHz When Loaded by ETSI (RTR/TM3036) HDSL Test Loops |
| VCM | | 2.5 | | V | |
| Output Power | | 13.5 | | dBm | |
| Output Voltage | | 6 | | V p-p Diff | |
| TRANSMIT VOLTAGE LEVEL | | 6 | | V p-p Diff | TX_GAIN = 0 TX_GAIN = 1 |
| | | 3 | | V p-p Diff | |
| RECEIVE CHANNEL | | | | | |
| SNR | 68 | 71 | | dB | |
| THD | 66 | 71 | | dB | |
| HYBRID INTERFACE | | | | | $V_{CM} = 2.5$ V. See Figure 3 |
| Input Voltage Range | | | 5 | V p-p Diff | |
| Input Impedance | | 10 | | kΩ | |
| PROGRAMMABLE GAIN AMPLIFIER | | | | | Condition -6 dB to +9 dB |
| Overall Gain Accuracy | | ±1 | | dB | |
| Gain Step | | 3 | | dB | |
| Gain Step Accuracy | | ±0.25 | | dB | |
| RECEIVE FILTER | | | | | MODE_SEL1 = 0 MODE_SEL1 = 1 |
| Corner Frequency (-3 dB) ¹ | | 320 | | kHz | |
| | | 640 | | kHz | |
| Accuracy | | ±5 | ±10 | % | |
| TIMING RECOVERY DAC | | | | | Guaranteed Monotonic |
| Resolution | 7 | | | Bits | |
| Output Low | | 0.5 | | V | |
| Output High | | 4.5 | | V | |
| DIGITAL INTERFACE | | | | | 5 V Supply, V_{MIN} to V_{MAX} 3.3 V Supply, V_{MIN} to V_{MAX} |
| Input Logic High, V_{IH} | 3.3 | | | V | |
| Input Logic Low, V_{IL} | | | 0.8 | V | |
| Output Logic High, V_{OH} | $V_{DD} - 0.3$ | | | V | |
| Output Logic Low, V_{OL} | | | 0.4 | V | |
| Input Logic High, V_{IH} | 2.0 | | | V | |
| Input Logic Low, V_{IL} | | | 0.2 | V | |
| Output Logic High, V_{OH} | $V_{DD} - 0.3$ | | | V | |
| POWER SUPPLY VOLTAGE | | | | | V_{MIN} to V_{MAX} 5 V Supply 3.3 V Supply |
| | 4.75 | 5 | 5.25 | V | |
| | 3.15 | 3.3 | 3.45 | V | |
| POWER SUPPLY CURRENT | | | | | V_{MIN} to V_{MAX} , T_{MIN} to T_{MAX} 5 V Supply, MODE_SEL1 = 0 5 V Supply, MODE_SEL1 = 1, MODE_SEL0 = 1 With 50 Ω Differential Load |
| Normal Mode, Excl. Driver | | 65 | | mA | |
| OVSAMP Mode | | 73 | | mA | |
| Line Driver | | 50 | | mA | |
| Low Power Mode | | 17 | | mA | |
| OPERATING TEMPERATURE RANGE | -40 | | +85 | °C | T_{MIN} to T_{MAX} |

NOTES

¹The ADC clock period $t(1+ f)$ is used for the dynamic tuning of the Tx and Rx filters.

Specifications subject to change without notice.

ABSOLUTE MAXIMUM RATINGS*

Supply Voltage -0.3 V to +6.0 V
 Input Voltage -0.5 V to $V_{DD} + 0.5$ V
 Output Voltage Swing -0.5 V to $V_{DD} + 0.5$ V
 Operating Temperature Range (Ambient) . . . -40°C to +85°C
 Storage Temperature Range -65°C to +150°C
 Lead Temperature (5 sec) MQFP +280°C

*Stresses above those listed in this section may cause permanent damage to the device. This is a stress rating only, functional operation of the device at these or any other conditions above those in the operation section of this specification is not implied. Exposure to absolute maximum rating conditions for extended periods may affect device reliability.

Thermal Characteristics

80-Lead Plastic Quad Flatpack Package $\theta_{JA} = 45^{\circ}C/W$

ORDERING GUIDE

| Model | Temperature Range | Package Description | Package Option |
|----------|-------------------|-------------------------------|----------------|
| AD6472BS | -40°C to +85°C | 80-Lead Plastic Quad Flatpack | S-80A |

PIN CONFIGURATION

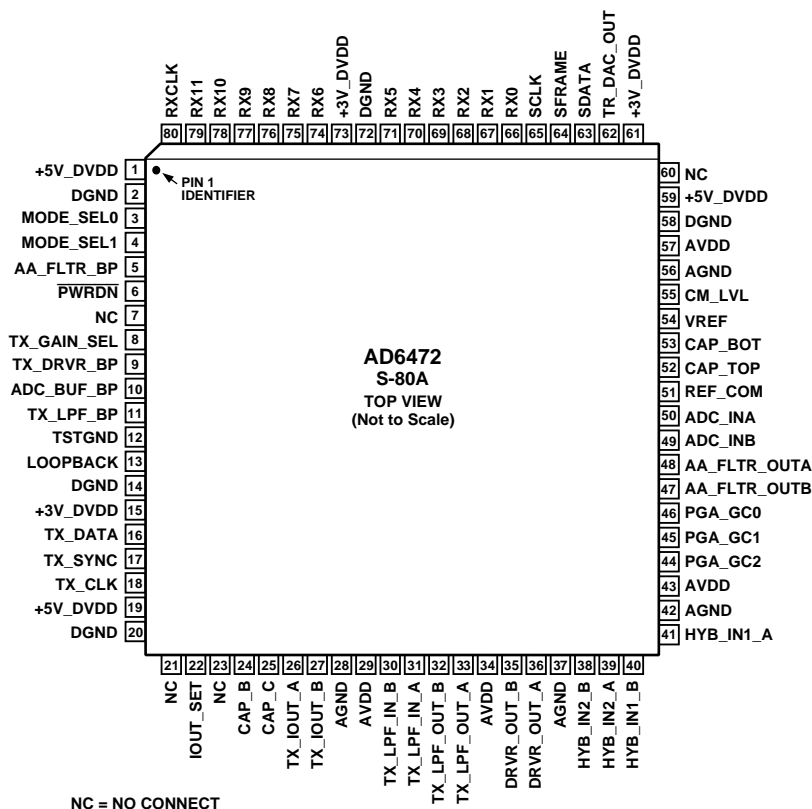

CAUTION

ESD (electrostatic discharge) sensitive device. Electrostatic charges as high as 4000 V readily accumulate on the human body and test equipment and can discharge without detection. Although the AD6472 features proprietary ESD protection circuitry, permanent damage may occur on devices subjected to high energy electrostatic discharges. Therefore, proper ESD precautions are recommended to avoid performance degradation or loss of functionality.



PIN CONFIGURATIONS

| Pin | Mnemonic | Description | Pin | Mnemonic | Description |
|-----|--------------|---|-----|--------------|--|
| 1 | +5 V_DVDD | +5 V Digital Supply. | 41 | HYB_IN1_A | Hybrid Inverting Input. |
| 2 | DGND | Digital Ground. | 42 | AGND | Analog Ground. |
| 3 | MODE_SEL0 | Bit Rate—Filter Corner Select. | 43 | AVDD | +5 V Analog Supply. |
| 4 | MODE_SEL1 | Bit Rate—Filter Corner Select. | 44 | PGA_GC2 | PGA Gain Select Bits. |
| 5 | AA_FLTR_BP | Antialiasing Filter Bypass. | 45 | PGA_GC1 | PGA Gain Select Bits. |
| 6 | PWRDN | Power-Down Active Low. | 46 | PGA_GC0 | PGA Gain Select Bits. |
| 7 | NC | No Connect. | 47 | AA_FLTR_OUTB | Differential Output of the Antialiasing Filter. |
| 8 | TX_GAIN_SEL | Transmit Attenuation (6 dB) Select. | 48 | AA_FLTR_OUTA | Differential Output of the Antialiasing Filter. |
| 9 | TX_DRV_R_BP | Transmit Driver Bypass. | 49 | ADC_INB | Differential Input to the ADC. |
| 10 | ADC_BUF_BP | ADC Buffer Bypass. | 50 | ADC_INA | Differential Input to the ADC. |
| 11 | TX_LPF_BP | Transmit Filter Bypass. | 51 | REF_COM | Reference Common. |
| 12 | TSTGND | Factory test pin. Connect to DGND. | 52 | CAP_TOP | Decoupling Pin for ADC Reference. |
| 13 | LOOPBACK | Loopback Select. | 53 | CAP_BOT | Decoupling Pin for ADC Reference. |
| 14 | DGND | Digital Ground. | 54 | VREF | External Voltage Reference. |
| 15 | +3 V_DVDD | +3.3 V Digital Supply. | 55 | CM_LVL | Common-Mode Level. (1/2 Supply Voltage, Nominally.) |
| 16 | TX_DATA | Transmit Data Input. | 56 | AGND | Analog Ground. |
| 17 | TX_SYNC | Transmit Data Frame Sync Input. | 57 | AVDD | +5 V Analog Supply. |
| 18 | TX_CLK | Transmit Clock Input. | 58 | DGND | Digital Ground. |
| 19 | +5 V_DVDD | +5 V Digital Supply. | 59 | +5 V_DVDD | +5 V Digital Supply. |
| 20 | DGND | Digital Ground. | 60 | NC | No Connect. |
| 21 | NC | No Connect. | 61 | +3 V_DVDD | +3 V Digital Supply. |
| 22 | IOUT_SET | DAC Output Current Full Scale (With Resistor to Ground). | 62 | TR_DAC_OUT | Timing Recovery DAC Output Voltage. |
| 23 | NC | No Connect. | 63 | SDATA | Serial Data Input to Timing Recovery DAC. |
| 24 | CAP_B | Decoupling Pin for Internal Node. | 64 | SFRAME | Frame Sync for Timing Recovery. |
| 25 | CAP_C | Decoupling Pin for Internal Node. | 65 | SCLK | Clock for Timing Recovery DAC. Serial Data. |
| 26 | TX_IOUT_A | TXDAC Complementary Current Output. | 66 | RX0 | Digital Output Data. |
| 27 | TX_IOUT_B | TXDAC Complementary Current Output. | 67 | RX1 | Digital Output Data. |
| 28 | AGND | Analog Ground. | 68 | RX2 | Digital Output Data. |
| 29 | AVDD | +5 V Analog Supply. | 69 | RX3 | Digital Output Data. |
| 30 | TX_LPF_IN_B | Differential Input to LPF. | 70 | RX4 | Digital Output Data. |
| 31 | TX_LPF_IN_A | Differential Input to LPF. | 71 | RX5 | Digital Output Data. |
| 32 | TX_LPF_OUT_B | Differential Output from Transmit (If Driver Bypassed). | 72 | DGND | Digital Ground. |
| 33 | TX_LPF_OUT_A | Differential Output from Transmit (If Driver Bypassed). | 73 | +3 V_DVDD | +3 V Digital Supply. |
| 34 | AVDD | +5 V Analog Supply. | 74 | RX6 | Digital Output Data. |
| 35 | DRV_R_OUT_B | Differential Driver Output. | 75 | RX7 | Digital Output Data. |
| 36 | DRV_R_OUT_A | Differential Driver Output. | 76 | RX8 | Digital Output Data. |
| 37 | AGND | Analog Ground. | 77 | RX9 | Digital Output Data. |
| 38 | HYB_IN2_B | Hybrid Noninverting Input. | 78 | RX10 | Digital Output Data. |
| 39 | HYB_IN2_A | Hybrid Noninverting Input. | 79 | RX11 | Digital Output Data. |
| 40 | HYB_IN1_B | Hybrid Inverting Input. | 80 | RXCLK | Clock Input for ADC Data. |

Circuit Description

The AD6472 is an HDSL analog front end for either 2-pair or single pair applications.

Transmit Channel

The AD6472 receives, from a DSP transceiver core, a serial 2s complement data stream. The data are 16-bit words and the MSB is received first.

The 12-bit DAC converts the digital data to an analog signal. Although HDSL uses four level 2B1Q modulation, the 12-bit DAC is necessary because of the linearity requirements of the echo canceling circuit.

The active filters have dynamic tuning and selectable filter corners that meet transmit mask requirements for both two-pair and single pair applications. A 6 dB attenuation option is included as part of the filter to increase the driver output dynamic range. Bypassing the active filter means giving up the 6 dB option, and reduces the maximum TX output voltage to 2 V p-p diff.

The filtered transmit signal is then processed by the driver amplifier. The DAC output controls the driver output level. The designer can choose to bypass the driver amplifier; in this case the driver amplifier will be powered down, and the TX output will be at the TX_LPF_OUT pins.

The AD6472 meets the requirements of the ETSI masks (both frequency and time domains for pulse shape). This includes the worst case in RTR/TM 3036.

Table I. Transmit Spectra

| Rate Kbps | Application | Nyquist Frequency kHz | Time Interval T (μs) |
|-----------|----------------|-----------------------|----------------------|
| 1168 | 2-Pair E1 | 292 | 1710 |
| 2320 | Single Pair E1 | 580 | 862 |

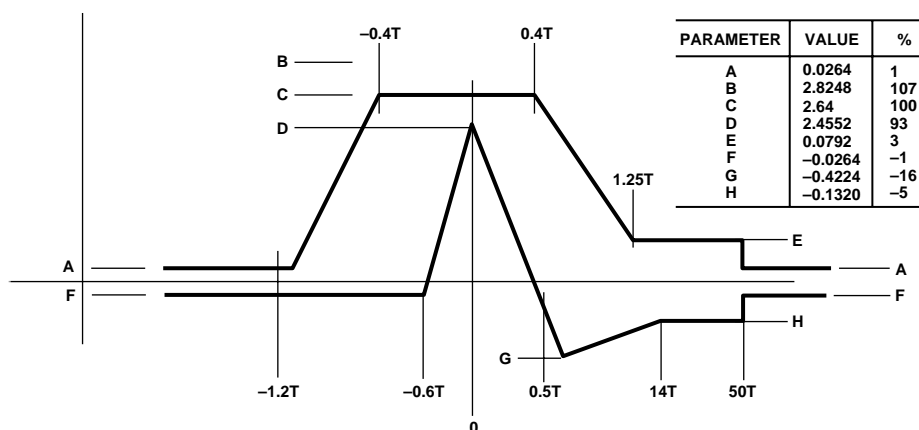

Figure 1. 2-pair Transmit Pulse Shape Mask Normalized

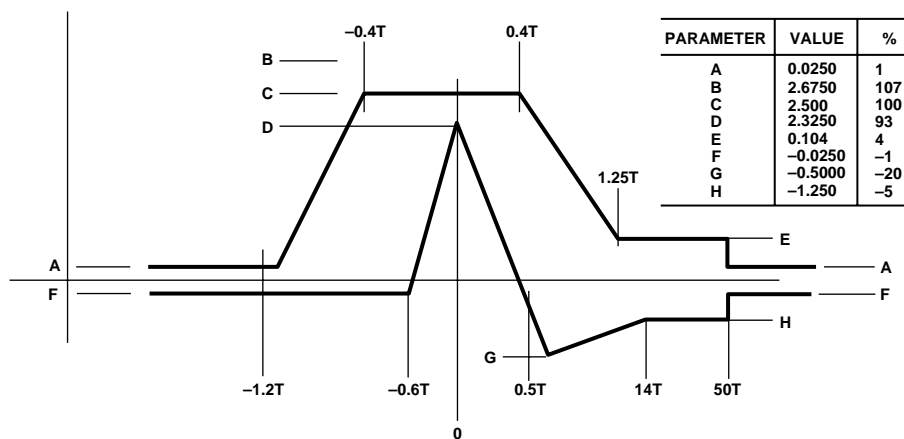

Figure 2. Single Pair Transmit Pulse Shape Mask Normalized

AD6472

Receive Channel

Hybrid Amplifier

The hybrid amplifier performs balanced to unbalanced conversion.

Programmable Gain Amplifier (PGA)

The PGA can be programmed to amplify the receive signal from between -6 dB and 9 dB. Refer to Table II for PGA gain control information.

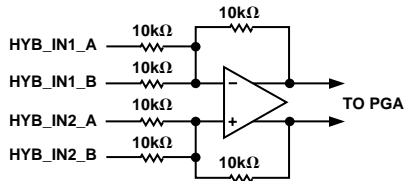

Figure 3.

Transmit and Receive Filters

Refer to Table III for transmit and receive channels filter control information. The receive channel filters meet ETSI requirements.

Analog-to-Digital Converter (ADC)

The receive channel ADC has a pipeline architecture with 12-bit resolution. The ADC can be clocked at 2320 kHz, maximum. Output data is provided in 2s complement form.

Timing Recovery D/A

The AD6472 has an integrated D/A converter to control an external VCXO used for timing recovery. The D/A is 7 bits and monotonic. The D/A accepts 7 bits inverted format input data serially with the MSB first.

Configuration Control

Table IV presents control information that you use to configure the AD6472.

Table II.

| Gain Control Bit | | | Binary Count GAIN (dB) |
|------------------|---------|---------|---------------------------|
| PGA_GC2 | PGA_GC1 | PGA_GC0 | |
| 0 | 0 | 0 | -6 |
| 0 | 0 | 1 | -3 |
| 0 | 1 | 0 | 0 |
| 0 | 1 | 1 | 3 |
| 1 | 0 | 0 | 6 |
| 1 | 0 | 1 | 9 |
| 1 | 1 | 0 | 9 |
| 1 | 1 | 1 | 9 |

Table III.

| Receive Channel MODE_SEL1 | Filter Control Bit MODE_SEL0 | Receive Clock Frequency (kHz) | 3 dB Frequency (kHz) |
|------------------------------|---------------------------------|----------------------------------|-------------------------|
| 0 | 0 | 1168/2 | Rx = 320/Tx = 320 |
| 0 | 1 | Reserved | Reserved |
| 1 | 0 | 1160 | Rx = 640/Tx = 535 |
| 1 | 1 | 1160 × 2 | Rx = 640/Tx = 535 |

Table IV. Configuration Control

| Pin | Mnemonic | Logic 0 = Function | Logic 1 = Function |
|-----|-------------|----------------------------|---------------------------|
| 5 | AA_FLTR_BP | Receive Filter in Circuit | Receive Filter Bypassed |
| 6 | PWRDN | Low Power Selected | Normal Operating Mode |
| 7 | ADC_BUF_BP | ADC Buffer in Circuit | ADC Buffer Bypassed |
| 8 | TX_GAIN_SEL | 0 dB Attenuation | 6 dB Attenuation |
| 9 | TX_DRVR_BP | Line Driver in Circuit | Line Driver Bypassed |
| 11 | TX_LPF_BP | Transmit Filter in Circuit | Transmit Circuit Bypassed |
| 13 | LOOPBACK | Normal Operation | Analog Loopback Selected |

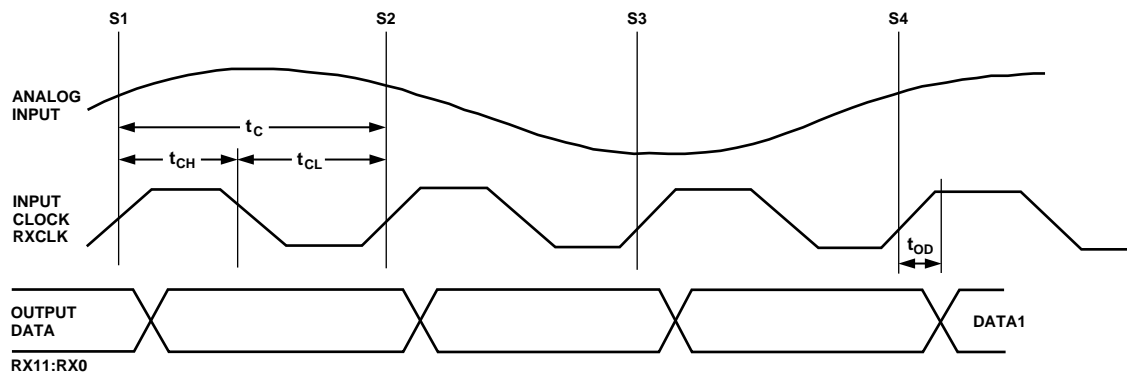

Figure 4. Receive Interface Timing Diagram

Receive Interface Timing

The analog input is sampled at the rising edge of the RXCLK. The digital data, RX11:RX0, is valid on each falling edge of RXCLK. Figure 4 shows a three-cycle latency on the receive data.

Table V through Table VII lists the RXCLK clock switching specifications for various RXCLK conditions. See Table IV, Configuration Control.

Table V. 40% to 60% Duty Cycle when the RXCLK = 1168 ÷ 2 kHz

| Symbol | Parameter | Min | Typ | Max | Units |
|----------|-----------------------|------|------|------|--------|
| t_c | Clock Period | | 1712 | | ns |
| t_{CH} | Clock Pulsewidth High | 685 | | 1027 | ns |
| t_{CL} | Clock Pulsewidth Low | 1027 | | 685 | ns |
| t_{OD} | Output Delay | 8 | 13 | 19 | ns |
| Latency | Pipeline Delay | 3 | 3 | 3 | Cycles |

Table VI. 40% to 60% Duty Cycle RXCLK Clock when the RXCLK = 1160 kHz

| Symbol | Parameter | Min | Typ | Max | Units |
|----------|-----------------------|-----|-----|-----|--------|
| t_c | Clock Period | | 862 | | ns |
| t_{CH} | Clock Pulsewidth High | 342 | | 514 | ns |
| t_{CL} | Clock Pulsewidth Low | 514 | | 342 | ns |
| t_{OD} | Output Delay | 8 | 13 | 19 | ns |
| Latency | Pipeline Delay | 3 | 3 | 3 | Cycles |

Table VII. 40% to 60% Duty Cycle RXCLK when the RXCLK = 1160 × 2 kHz

| Symbol | Parameter | Min | Typ | Max | Units |
|----------|-----------------------|-----|-----|-----|--------|
| t_c | Clock Period | | 431 | | ns |
| t_{CH} | Clock Pulsewidth High | 171 | | 257 | ns |
| t_{CL} | Clock Pulsewidth Low | 257 | | 171 | ns |
| t_{OD} | Output Delay | 8 | 13 | 19 | ns |
| Latency | Pipeline Delay | 3 | 3 | 3 | Cycles |

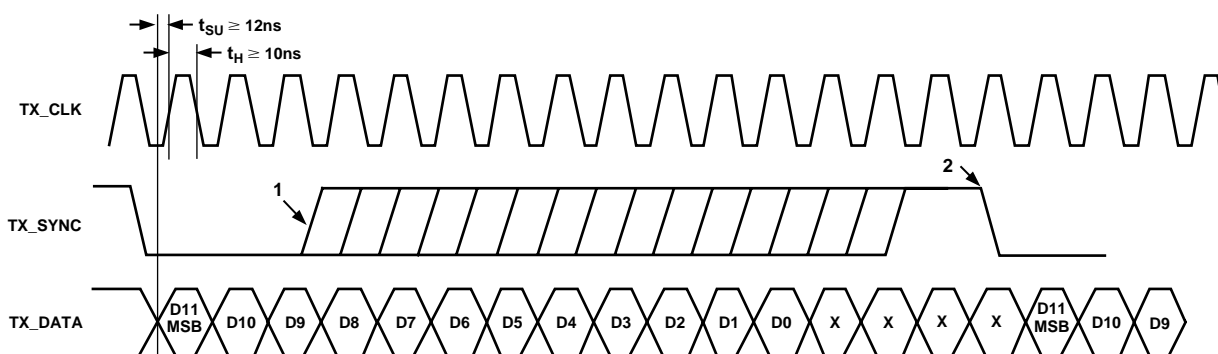

1. THE RISING EDGE TO TX_SYNC CAN OCCUR ANYWHERE. TX_SYNC MUST BE AT LEAST ONE CLOCK CYCLE WIDE.
2. TX_SYNC FALLING EDGE MUST OCCUR AFTER THE TX_CLK RISING EDGE THAT CAPTURED THE SERIAL LSB. THIS ENSURES CORRECT LOADING INTO THE DAC.

THE FIRST 12 BITS OF THE 16-BIT SERIAL WORD ARE THE INPUT TO THE TX PATH DAC, MSB FIRST. THE NUMBER SYSTEM IS TWOS COMPLEMENT, AS FOLLOWS:

| OUTPUT | WORD |
|---------------------------|--------------|
| FULL SCALE | 011111111111 |
| 1/2 FULL SCALE | 000000000000 |
| 1/2 FULL SCALE MINUS 1LSB | 111111111111 |
| ZERO | 100000000000 |

Figure 5. Transmit Interface Timing Diagram

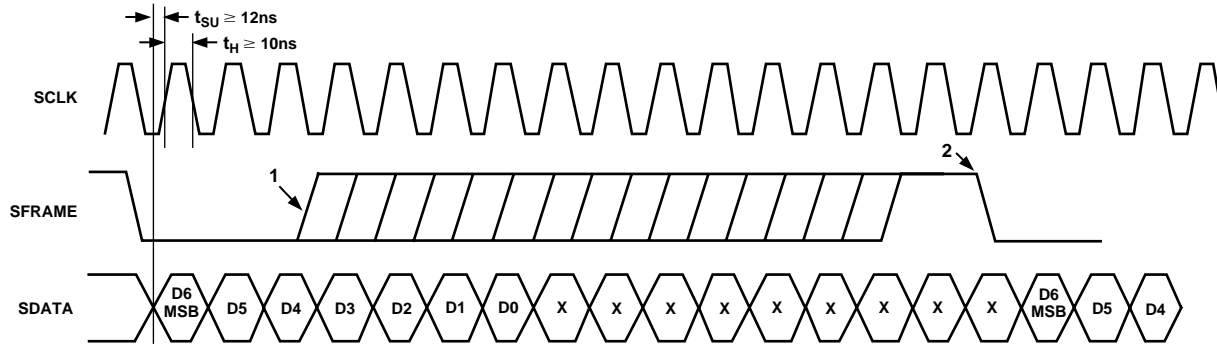

1. THE RISING EDGE OF SFRAME CAN OCCUR ANYWHERE. SFRAME MUST BE AT LEAST ONE CLOCK CYCLE WIDE.
 2. SFRAME FALLING EDGE MUST OCCUR BEFORE THE SCLK RISING EDGE THAT CAPTURED THE SERIAL LSB. THIS ENSURES CORRECT LOADING INTO THE DAC.
- THE FIRST 7 BITS OF THE 16-BIT SERIAL WORD ARE THE INPUT TO THE TR DAC, MSB FIRST. THE NUMBER SYSTEM IS TWOS COMPLEMENT, AS FOLLOWS:

| OUTPUT | WORD | VOLTAGE |
|------------|---------|---------|
| FULL SCALE | 1111111 | 4.5 |
| MID-SCALE | 1000000 | 2.5 |
| MINIMUM | 0000000 | 0.5 |

Figure 6. Timing Recovery DAC Converter Timing

PCB Layout Recommendations

| | |
|----------------------------------|---|
| Analog and Digital Ground Planes | Separate the analog and digital grounds. Use a single 35 to 50 mil wide trace under the device to connect the two ground planes. Connect the IC ground pins directly to the respective ground planes. |
| Power Supply Capacitors | Use one 0.1 μ F capacitor for each IC decoupling power supply connection in addition to capacitance shown in schematic. |

OUTLINE DIMENSIONS

Dimensions shown in inches and (mm).

80-Lead Metric Plastic Quad Flatpack S-80A

