

## N-Channel Enhancement Mode Power MOSFET

### ■ Features

- Low Gate Charge
- Simple Drive Requirement
- Fast Switching
- RoHS Compliant
- Pb Free Plating Product

### ■ General Description

The TO-252 package is universally preferred for all commercial-industrial surface mount applications and suited for low voltage applications such as DC/DC converters. The through-hole version is available for low-profile applications.

### ■ Product Summary

$BV_{DSS}$ (V)	$R_{DS(ON)}$ (m $\Omega$ )	$I_D$ (A)
30	6	75

### ■ Pin Assignments

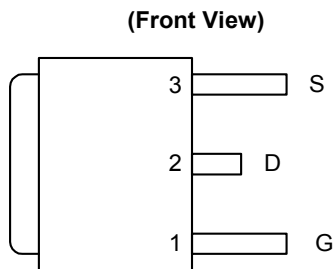

### ■ Pin Descriptions

Pin Name	Description
S	Source
G	Gate
D	Drain

### ■ Ordering information

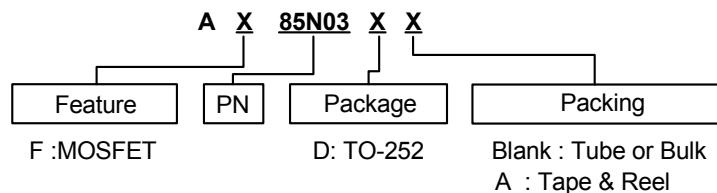

### ■ Block Diagram

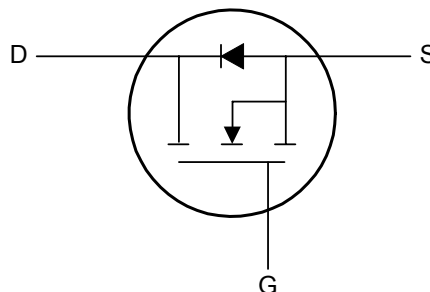



N-Channel Enhancement Mode Power MOSFET

■ Absolute Maximum Ratings

Symbol	Parameter	Rating	Units
$V_{DS}$	Drain-Source Voltage	30	V
$V_{GS}$	Gate-Source Voltage	$\pm 20$	V
$I_D$	Continuous Drain Current, $V_{GS}=4.5V$	$T_C=25^\circ C$	75
		$T_C=100^\circ C$	55
$I_{DM}$	Pulsed Drain Current (Note 1)	350	A
$P_D$	Total Power Dissipation	$T_C=25^\circ C$	107
	Linear Derating Factor		0.7
$T_{STG}$	Storage Temperature Range	-55 to 175	$^\circ C$
$T_J$	Operating Junction Temperature Range	-55 to 175	$^\circ C$

■ Thermal Data

Symbol	Parameter	Maximum	Units
$R_{\theta JC}$	Thermal Resistance Junction-Case	Max.	1.4
$R_{\theta JA}$	Thermal Resistance Junction- Ambient	Max.	110

■ Electrical Characteristics ( $T_J=25^\circ C$  unless otherwise noted)

Symbol	Parameter	Test Conditions	Limits			Unit
			Min.	Typ.	Max.	
$BV_{DSS}$	Drain-Source Breakdown Voltage	$V_{GS}=0V, I_D=250\mu A$	30	-	-	V
$\Delta BV_{DSS}/\Delta T_J$	Breakdown Voltage Temperature Coefficient	Reference to $25^\circ C$ , $I_D=1mA$	-	0.018	-	$V/^\circ C$
$R_{DS(ON)}$	Static Drain-Source On-Resistance (Note 2)	$V_{GS}=10V, I_D=45A$	-	-	6	m $\Omega$
		$V_{GS}=4.5V, I_D=30A$	-	-	10	
$V_{GS(th)}$	Gate Threshold Voltage	$V_{DS}=V_{GS}, I_D=250\mu A$	1	-	3	V
$g_{fs}$	Forward Transconductance	$V_{DS}=10V, I_D=30A$	-	32	-	S
$I_{DSS}$	Drain-Source Leakage Current( $T_J=25^\circ C$ )	$V_{DS}=30V, V_{GS}=0V$	-	-	1	uA
	Drain-Source Leakage Current( $T_J=175^\circ C$ )	$V_{DS}=24V, V_{GS}=0V$	-	-	500	
$I_{GSS}$	Gate Source Leakage	$V_{GS}=\pm 20V$	-	-	$\pm 100$	nA
$Q_g$	Total Gate Charge (Note 2)	$I_D=30A$	-	33	52	nC
$Q_{gs}$	Gate-Source Charge	$V_{DS}=24V$	-	7.5	-	
$Q_{gd}$	Gate-Drain ("Miller") Charge	$V_{GS}=4.5V$	-	24	-	
$t_{d(on)}$	Turn-On Delay Time (Note 2)	$V_{DS}=15V$	-	11.2	-	nS
$t_r$	Rise Time	$I_D=30A$	-	77	-	
$t_{d(off)}$	Turn-Off Delay Time	$R_G=3.3\Omega, V_{GS}=10V$	-	35	-	
$t_f$	Fall-Time	$R_D=0.5\Omega$	-	67	-	
$C_{iss}$	Input Capacitance	$V_{GS}=0V$	-	2700	4200	pF
$C_{oss}$	Output Capacitance	$V_{DS}=25V,$	-	550	-	
$C_{rss}$	Reverse Transfer Capacitance	$f=1.0MHz$	-	380	-	

■ Source-Drain Diode

Symbol	Parameter	Test Conditions	Min.	Typ.	Max.	Unit
$V_{SD}$	Forward On Voltage (Note 2)	$I_S=45A, V_{GS}=0V$	-	-	1.3	V
$t_{rr}$	Reverse Recovery Time	$I_S=30A, V_{GS}=0V,$	-	28	-	ns
$Q_{rr}$	Reverse Recovery Charge	$di/dt=100A/\mu s$	-	10	-	nC

Note 1: Pulse width limited by safe operating area.

Note 2: Pulse width  $\leq 300\mu s$ , duty cycle  $\leq 2\%$ .

## N-Channel Enhancement Mode Power MOSFET

### Typical Performance Characteristics

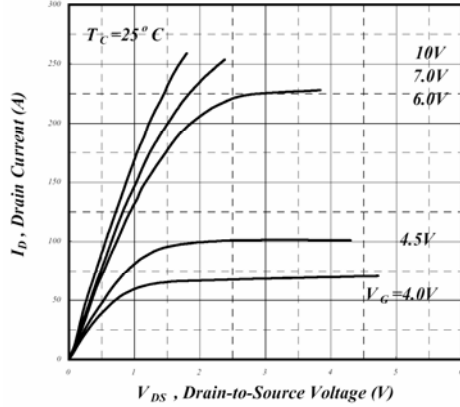

Fig 1. Typical Output Characteristics

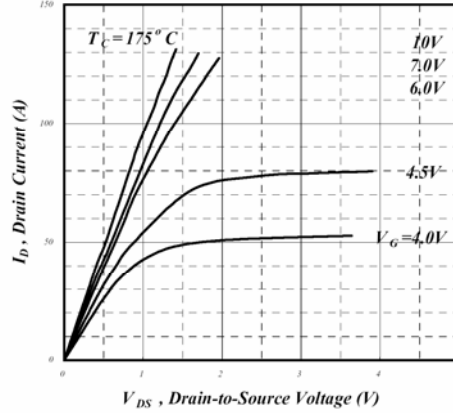

Fig 2. Typical Output Characteristics

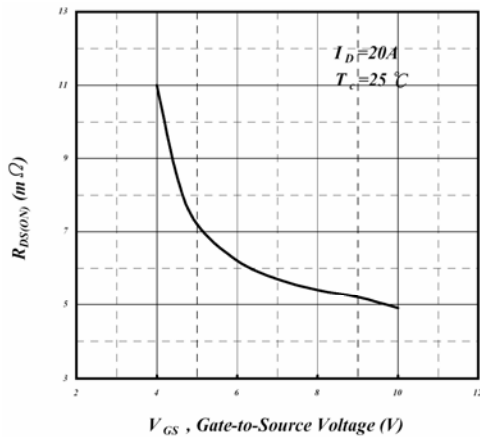

Fig 3. On-Resistance v.s. Gate Voltage

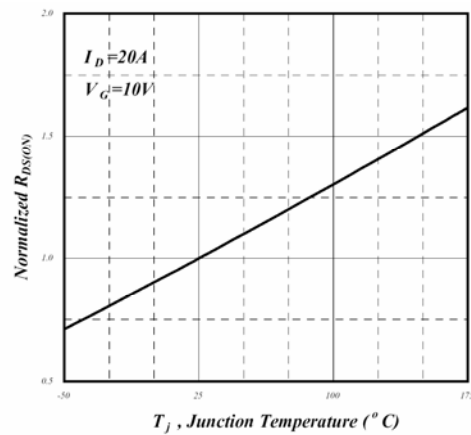

Fig 4. Normalized On-Resistance v.s. Junction Temperature

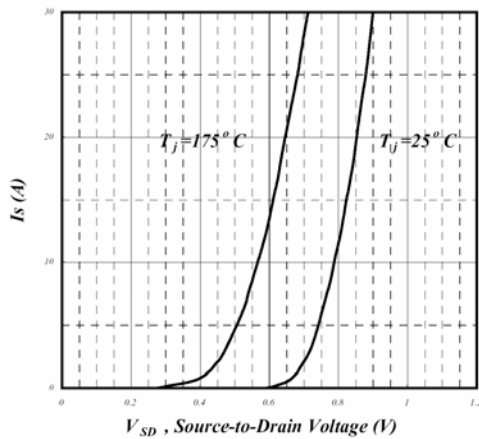

Fig 5. Forward Characteristic of Reverse Diode

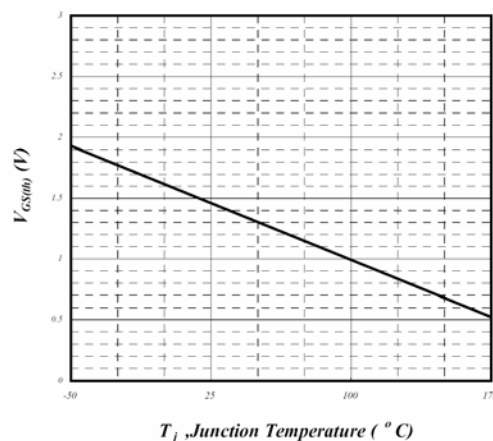

Fig 6. Gate Threshold Voltage v.s. Junction Temperature

## N-Channel Enhancement Mode Power MOSFET

### ■ Typical Performance Characteristics

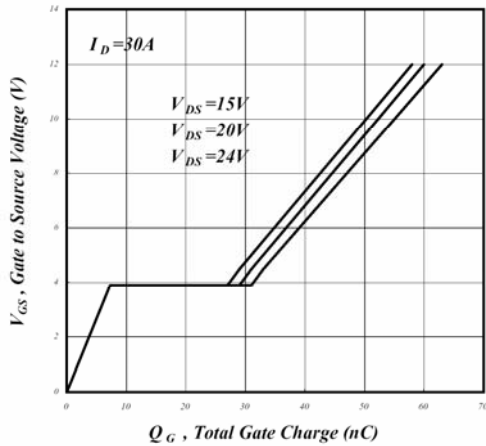

Fig 7. Gate Charge Characteristics

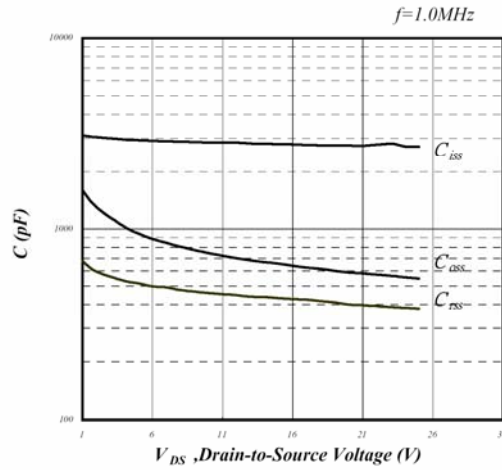

Fig 8. Typical Capacitance Characteristics

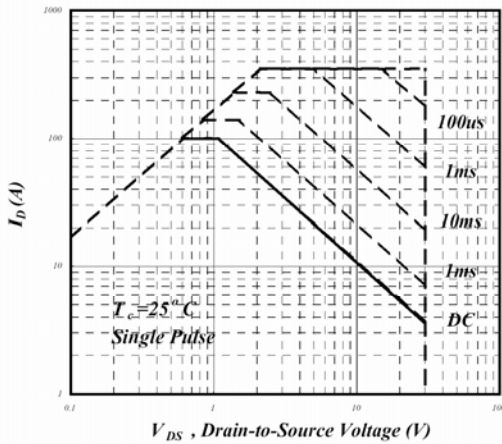

Fig 9. Maximum Safe Operating Area

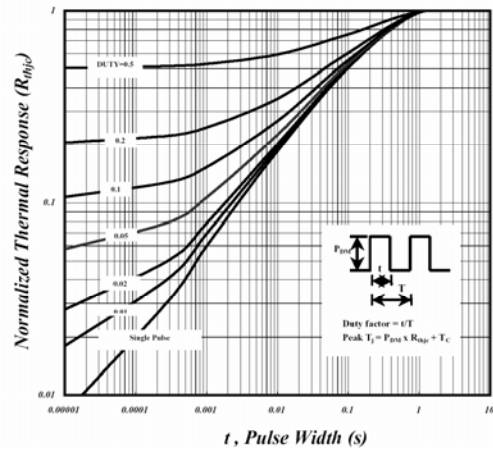

Fig 10. Effective Transient Thermal Impedance

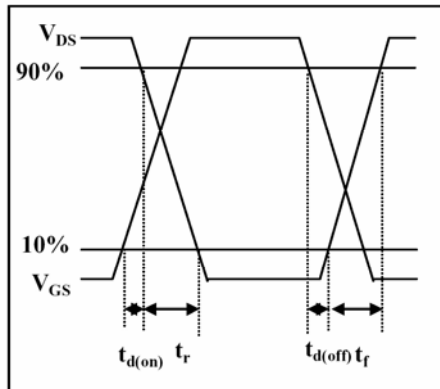

Fig 11. Switching Time Waveform

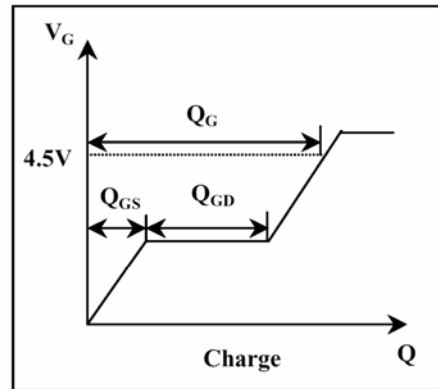
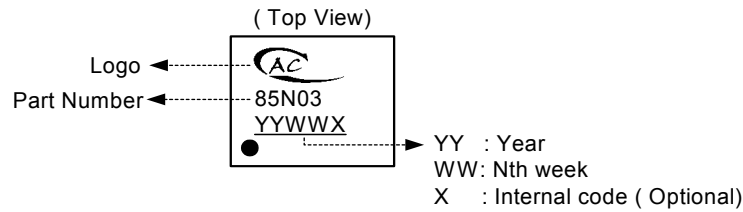

Fig 12. Gate Charge Waveform

## N-Channel Enhancement Mode Power MOSFET

### ■ Marking Information

TO-252



### ■ Package Information

Package Type: TO-252

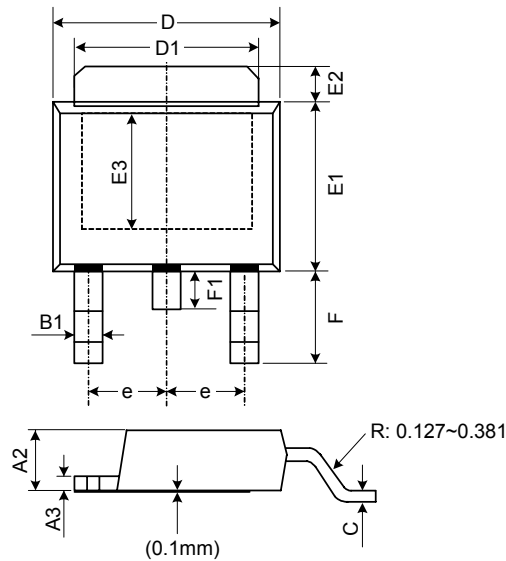

1. All Dimensions Are in Millimeters.
2. Dimension Does Not Include Mold Protrusions.

Symbol	Dimensions In Millimeters		
	Min.	Nom.	Max.
A2	1.80	2.30	2.80
A3	0.40	0.50	0.60
B1	0.40	0.70	1.00
D	6.00	6.50	7.00
D1	4.80	5.35	5.90
F	2.20	2.63	3.05
F1	0.50	0.85	1.20
E1	5.10	5.70	6.30
E2	0.50	1.10	1.70
E3	3.50	4.00	4.50
e	-	2.30	-
C	0.35	0.50	0.65